



Si-05B

# Service Manual

## ***VRV* System** **Inverter K Series** **PLUS Series**



Большая библиотека технической документации

<https://splitsystema48.ru/instrukcii-po-ekspluatacii-kondicionerov.html>

каталоги, инструкции, сервисные мануалы, схемы.

## PREFACE

The VRV System Inverter K Series is designed for easy installation and maintenance. Although it has all the features of the previous VRV System Inverter Series, the method of displaying the model name has been changed in order to conform to revision in Japanese Industrial Standards, the method of transmission between outdoor and indoor units has been changed, the equipment has been modified so the same wiring is used for transmission between indoor/outdoor units and centralized control, and can now be connected with a central remote controller.

This maintenance manual was published in order to help you get a solid understanding of these functions, and so you can provide fast and reliable after sales service. Although the contents of the manual may be insufficient in some areas, we hope that you will use it to the best of your ability.

The service manual for the VRV PLUS Series (cool/heat selection system) explains the new methods (super piping and super wiring) featured by the system in four sections: Outline, Functions, Test Operation and Troubleshooting.

Compared with previous VRV Inverter System equipment, the VRV PLUS series is designed to facilitate construction and save space, and is equipped with a unique service mode. The manual is intended for use when troubleshooting or executing test operation.

If you find the manual to be insufficient in any of its explanations, please let us know so we can improve on later editions.

May 1997

After Sales Service Division

# CONTENTS

## VRV Inverter K Series

### GENERAL INFORMATION

<b>1. Series Introduction</b>	
Nomenclature .....	2
Indoor/Outdoor Unit Combinations .....	4
<b>2. Outline of System</b>	
1. Easily Recognizable Features of the K Series .....	5
2. Changes in K Series Functions / Parts .....	6
3. Compatibility of Old and New VRV System Inverter .....	9

### FUNCTIONS

1. Outdoor Unit Refrigerant System Diagram .....	12
2. Function of Thermistors and Pressure Sensors .....	16
3. List of Safety Devices and Functional Parts Setting Values .....	17
4. Safety for Restart .....	18
(1)Restart Safety Timer .....	18
(2)Soft Start .....	19
(3)Pump Down Start .....	19
(4)Heating Lay-Up Start .....	20
5. Equalized Oil Level Operation .....	20
6. Oil Return Operation .....	21
7. Defrost .....	22
8. Heating Pump Down Residual Operation .....	23
9. Step Down / Safety Control .....	24
10. Control During Low Outdoor Air Temperature Cooling .....	25
11. Low Noise Control .....	26
12. Demand Control .....	26
13. Compressor Capacity Control .....	27
14. Te / Tc Setting .....	28
15. Gas Depletion Alarm .....	29
16. Drain Pump Control .....	30
17. Oil Temperature Sensor .....	32
18. Louver Control for Preventing Ceiling Dirt .....	33
19. Thermostat Sensor in Remote Controller .....	34
20. Freeze Prevention .....	36

### TEST OPERATION

1. When Power is Turned On .....	38
2. Outdoor Unit PC Board Ass'y .....	39
3. Setting Modes .....	40
(1)Setting Mode 1 .....	41
(2)Setting Mode 2 .....	42
(3)Monitor Mode .....	44
4. Sequential Start .....	46
5. External Control Adaptor for Outdoor Unit .....	47
6. Cool / Heat Mode Selection .....	49
7. Low Noise / Demand Operation .....	53
8. Wiring Check Operation .....	55
9. Indoor Unit PCB Ass'y .....	56
10. Remote Controllers (Wired and Wireless) .....	57
11. Control by Remote Controller (Double Remote Controllers, Group, Remote) .....	61
12. Indoor Field Setting .....	62
13. Centralized Control Group No. Setting .....	64
14. Setting of Master Remote Controller .....	65
15. Remote Controller Self-Diagnosis Function .....	66
16. Operation of the Remote Controller's Inspection / Test Operation Button .....	68
17. Remote Controller Service Mode .....	69
18. Model Change of Centralized Control Devices .....	71
19. Central Remote Controller .....	74
20. Unified ON/OFF Controller .....	78
21. Schedule Timer .....	80
22. Combining Different Types of Centralized Control Devices .....	82

### TROUBLESHOOTING

1. Operation Flowcharts .....	86
2. Diagnosis by Malfunction Code .....	93
3. Failure Diagnosis .....	95
4. Failure Diagnosis for Inverter System .....	124
5. How to use the Monitor switch on the Inverter PC Board .....	125
6. Failure Diagnosis for Central Remote Controller .....	134
7. Failure Diagnosis for Schedule Timer .....	138
8. Failure Diagnosis for Unified ON/OFF Controller .....	142
9. Appendix	
(1)Precautions When Replacing K Series PC Boards .....	146
(2)Precautions Concerning the Remote Controller's Mode No. .....	146
(3)Typical Wiring Mistakes .....	147

# VRV PLUS Series

## GENERAL INFORMATION

1. Features of the VRV PLUS Series .....152
2. System Outline .....154
3. Indoor/Outdoor Unit Combinations .....155

## FUNCTIONS

1. Outdoor Unit Refrigerant System Diagrams ...158
2. Function of Thermistors and Pressure Sensors .....172
3. List of Safety Devices and Functional Parts Setting Values .....174
4. Flow of Refrigerant in Each Operating Mode .....175
  - (1) Heat pump model .....175
  - (2) Cooling only model .....189
5. Outline of Control .....197
  - (1) Starting Control .....197
  - (2) Pressure Equalizing Control Before Starting .....200
  - (3) Oil Return Control .....201
  - (4) Defrost .....203
  - (5) Oil Equalization Control .....204
  - (6) Heating Pump Down Residual Operation...207
  - (7) Compressor Oil Temperature Protection Control .....208
  - (8) Low Pressure Protection Control Step .....209
  - (9) High Pressure Control Step .....210
  - (10) Discharge Temperature Protection Control ...212
  - (11) Cooling Overload Control .....213
  - (12) Inverter Protection Control .....213
  - (13) Standby by Outdoor Temperature When Heating .....213
  - (14) Low Outdoor Temperature Control When Cooling .....214
  - (15) Low Noise Control .....215
  - (16) Demand Control .....215
  - (17) Compressor Capacity Control .....216
  - (18) Backup Operation .....218
  - (19) Emergency Operation .....219
  - (20) Pump Down Operation .....223

## TEST OPERATION

1. Procedure and Outline.....226
2. Operation When Power is Turned On .....227
3. Outdoor Unit PC Board Ass'y .....228
4. Switch Settings According to Number of Outdoor Units .....229
5. Setting Modes .....230
  - (1) Setting Mode 1 .....231
  - (2) Setting Mode 2 .....232
  - (3) Monitor Mode .....234
6. Sequential Start.....236
7. External Control Adaptor for Outdoor Units ...237
8. Cool / Heat Mode Switching .....239
9. Low Noise Operation .....242
10. Demand Control .....243
11. Wiring Check Operation .....244

## TROUBLESHOOTING

1. Troubleshooting for VRV PLUS Series .....246
2. Diagnosis by Malfunction Code .....247
3. Troubleshooting .....248
4. Failure Diagnosis for Inverter System.....268
5. How to use the Monitor switch on the Inverter PC Board .....269

## SPECIAL SERVICE MODE

1. Backup and Emergency Operation .....280
2. Pump Down Operation When Replacing the Compressor .....282

## APPENDIX

.....Inverter K Series PLUS Series

1. Wiring Diagrams .....286
2. Thermistor resistance / Temperature Characteristics .....319
3. Pressure sensor voltage output / Detected Pressure Characteristics .....321
4. Method of Replacing the Inverter's Power Transistors and Diode Modules .....322
5. Wiring Adaptor for Electrical Appendices .....323
6. Wiring Adaptor for Group Electrical Appendices .....325
7. Adaptor for Wiring .....327
8. Interface Adaptor for SKY AIR Series .....328
9. Wiring Adaptor for Other Air Conditioners ...329
10. External Control Adaptor for Outdoor Units ...330
11. Unification Adaptor for Computerized Control .....332

# **GENERAL INFORMATION**

## **Inverter K Series**

# 1. Series Introduction

## NOMENCLATURE

### • Indoor Unit

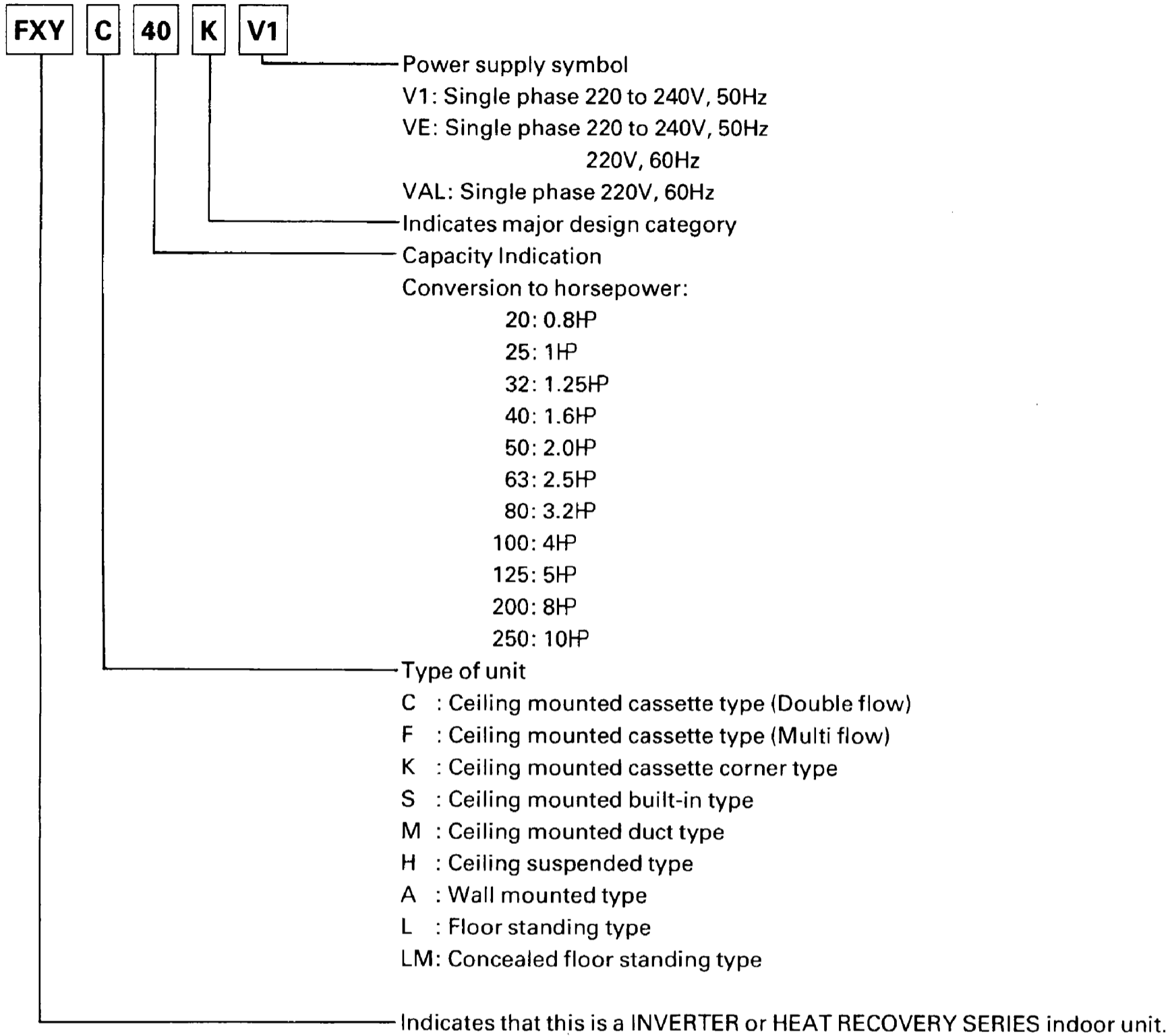

• Outdoor Unit

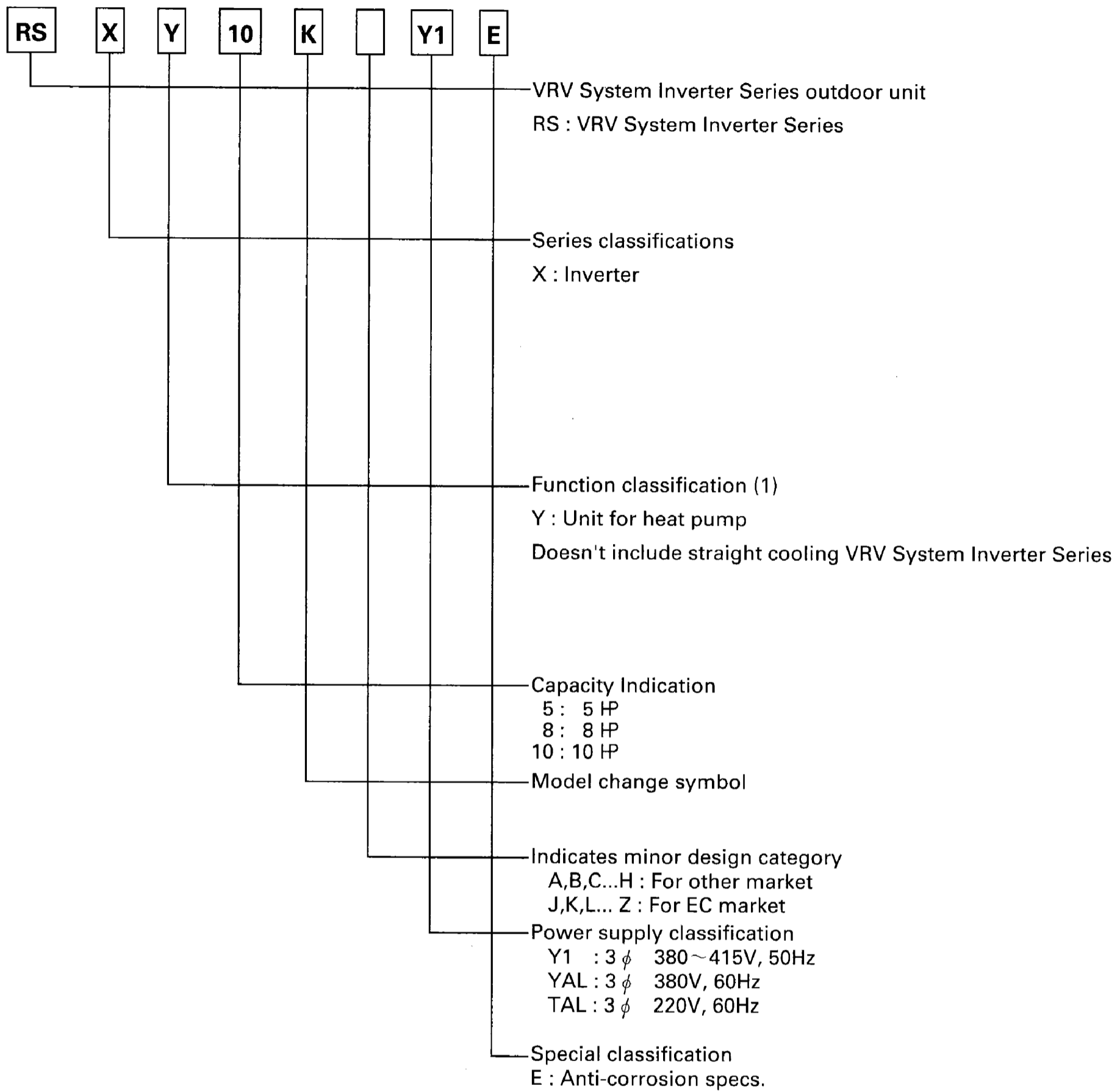

## Indoor/Outdoor Unit Combinations

### ■ VRV System Inverter K Series

VRV System Inverter K Series outdoor unit model	RSXY5K	RSXY8K	RSXY10K
Total connectable indoor units	Max. 8 units	Max. 13	Max. 16

### ■ Straight Cooling VRV System Inverter

VRV System Inverter EXC Series outdoor unit model	RSX5K	RSX8K	RSX10K
Total connectable indoor units	Max. 8 units	Max. 13	Max. 16



## 2. Outline of System

### 1. Easily Recognizable Features of the "K" Series

#### VRV System Inverter K Series System Outline

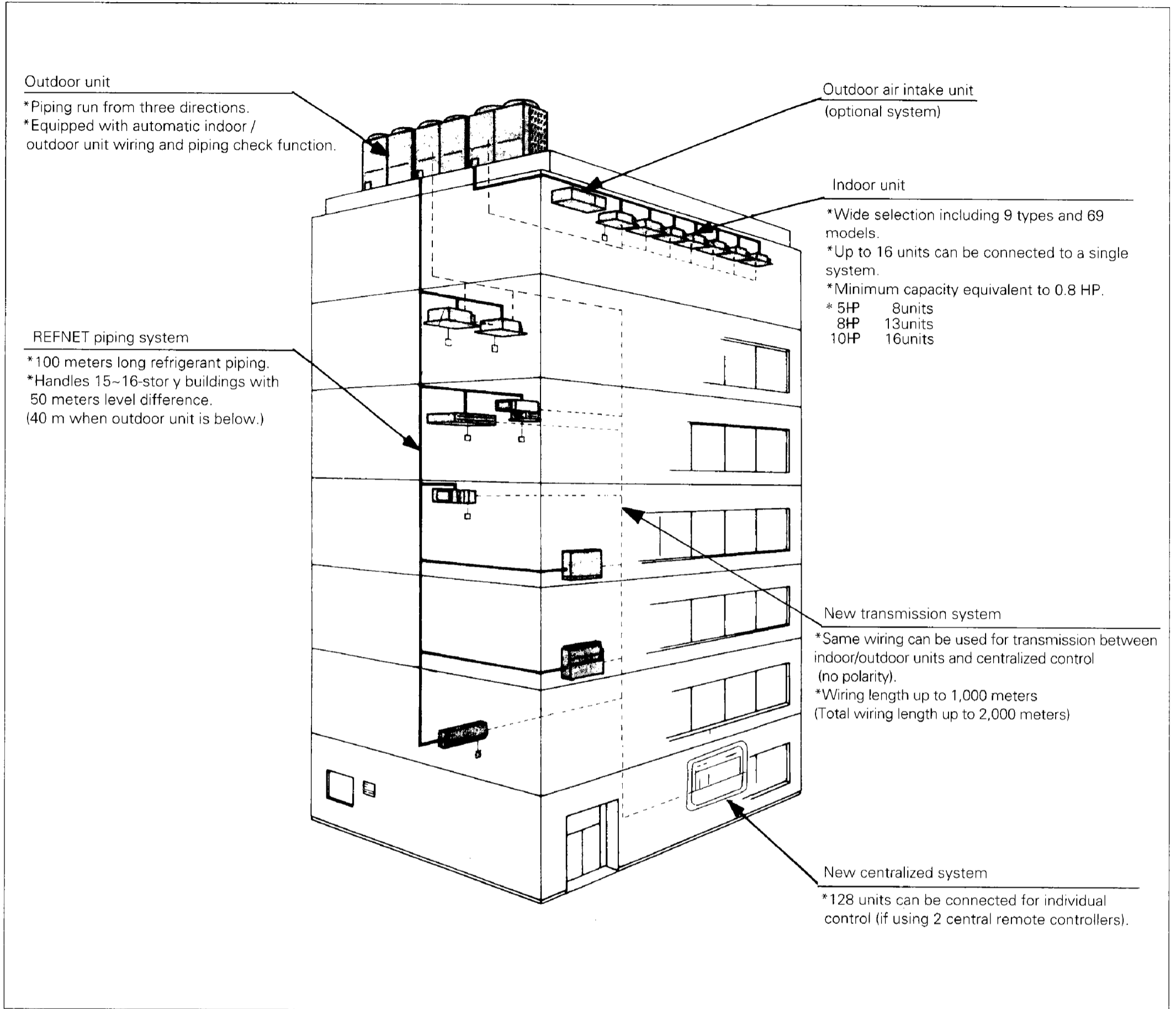

## 2. Changes in K Series Functions / Parts

### (1) Changes in the System as a Whole

- **More outdoor units can be connected.**

A maximum of 16 indoor units can now be connected to a single system.

5HP ..... 8 units  
 8HP ..... 13 units  
 10HP ..... 16 units

- **Same wiring can be used for transmission between indoor/outdoor units and centralized control**

Up to now, separate wiring was required for centralized control and for transmission between indoor/outdoor units when installing optional controllers for centralized control, but now the same wiring can be used for both. This facilitates indoor/outdoor transmission wiring construction work as follows.

#### H Series

- Separate input and output terminals.
- Has polarity.
- Only serial wiring can be used.
- Wiring can be up to 1,000 meters long.

#### K Series

- Same terminals used for input and output.
- No polarity.
- 3 wiring methods can be used (serial, bus and star wiring).
- Up to 16 branches can be used. (Cannot be branched again once branched.)
- System wiring can be up to a total of 2,000 meters. (Max. wiring length up to 1,000 meters).

#### Indoor unit terminal block

H Series	Input		Output		Remote controller		Centralized		Forced off	
	1	2	1	2	P1	P2	F1	F2	T1	T2



K Series	Remote controller		Transmission wiring		External	
	N	P	F1	F2	T1	T2

#### Outdoor unit terminal block

H Series	C / H selector			Output		Out / D unit input		Out / D unit output		Sequential start KRP 80 - 51	
	A	B	C	1	2	3	4	3	4	5	6



K Series	C / H selector			To In / D unit		To Out / D unit	
	A	B	C	F1	F2	F1	F2

- **2 central remote controller can be connected in a transmission system.**

VRV System Inverter K Series equipment can be connected with two central remote controllers, and can individual control 128 unit (64 units × 2) on a single transmission line.

• **Change in mode of transmission between outdoor units**

Wiring for transmission between outdoor units is necessary for selecting cool or heat mode for several units at once. This transmission has been changed as follows.

**H Series**

- Separate input and output terminals.
- Sequential start requires adaptor PC board.
- Simultaneous cool/heat selection and low noise operation require only wiring between outdoor units and setting.

**K Series**

- Same terminals used for input and output.
- Sequential start requires only wiring between outdoor units and setting.
- Simultaneous cool/heat selection and low noise operation require a separate adaptor for outside control of outdoor units.
- Transmission can be conducted between a maximum of 10 units.
- Optional controllers for centralized control can be connected to

• **VRV System Inverter K Series**

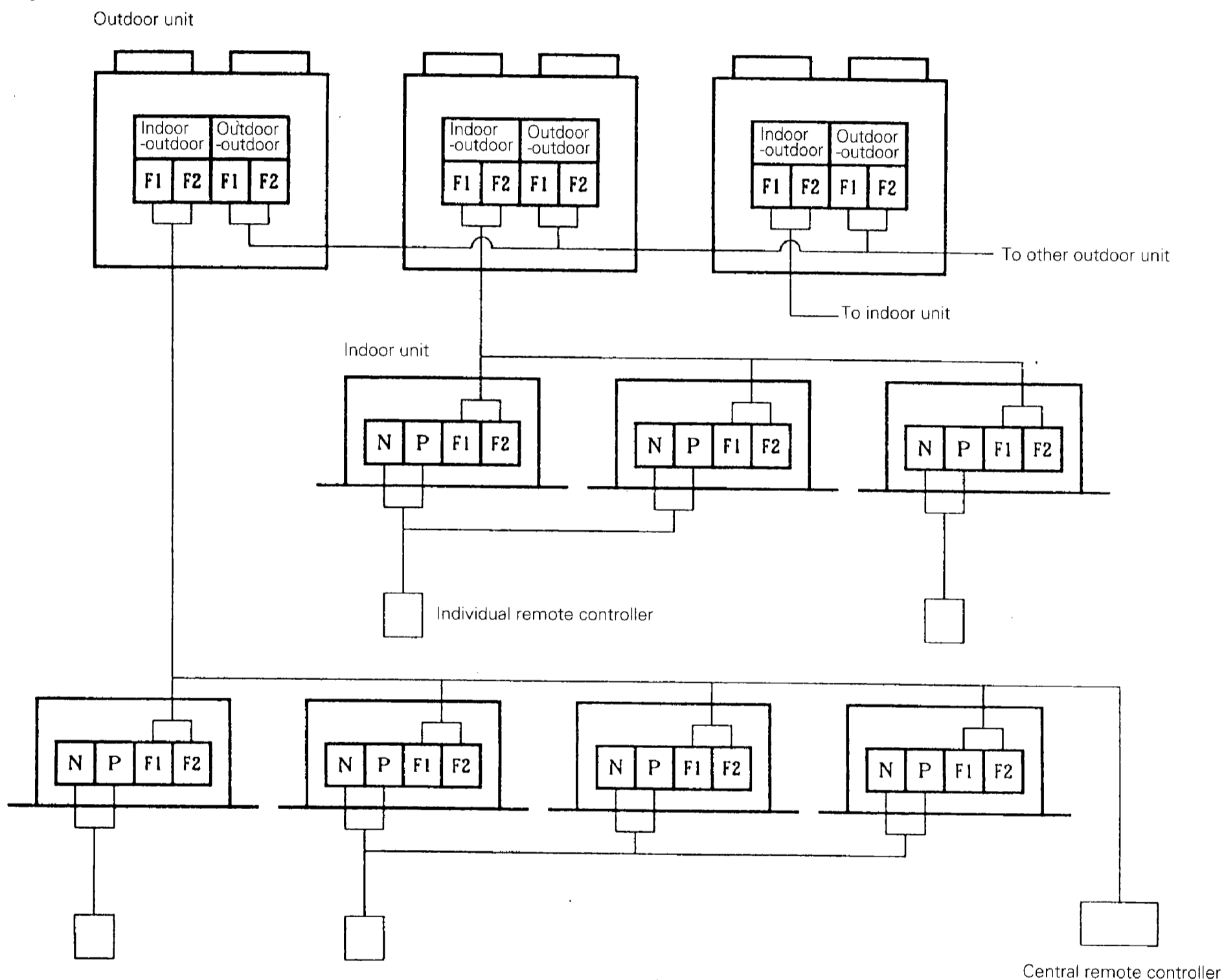

## **(2) Changes in Indoor Units**

- **Drain pump**

When the TEST OPERATION button has been pushed in order to facilitate checking drainage when installing, the drain pump is force-operated regardless of the temperature control mode. If a humidifier is to be included in the setup, you must set to “using humidifier” with the remote controller. (With the factory settings, the drain pump is not operated during heating.)

- **Swing louver**

The wall mounted type is equipped with a swing louver . The ceiling mounted cassette type can be set to prevent the ceiling from being soiled.

- **Able to use wireless remote controllers**

The multi flow, double flow, ceiling suspended and wall mounted types can be fitted with a wireless remote controller kit. (Other types can use a separate wireless remote controller.)

## **(3) Changes in Outdoor Units**

- **Equipped with oil temperature sensor thermistor (8 and 10HP)**

Oil temperature detection has been incorporated into control in order to prevent wet operation and improve dilution of oil.

### 3. Compatibility of Old and New VRV System Inverter

#### (1) H Series indoor units:

Cannot be connected to new outdoor unit

##### ■ Connectable combinations

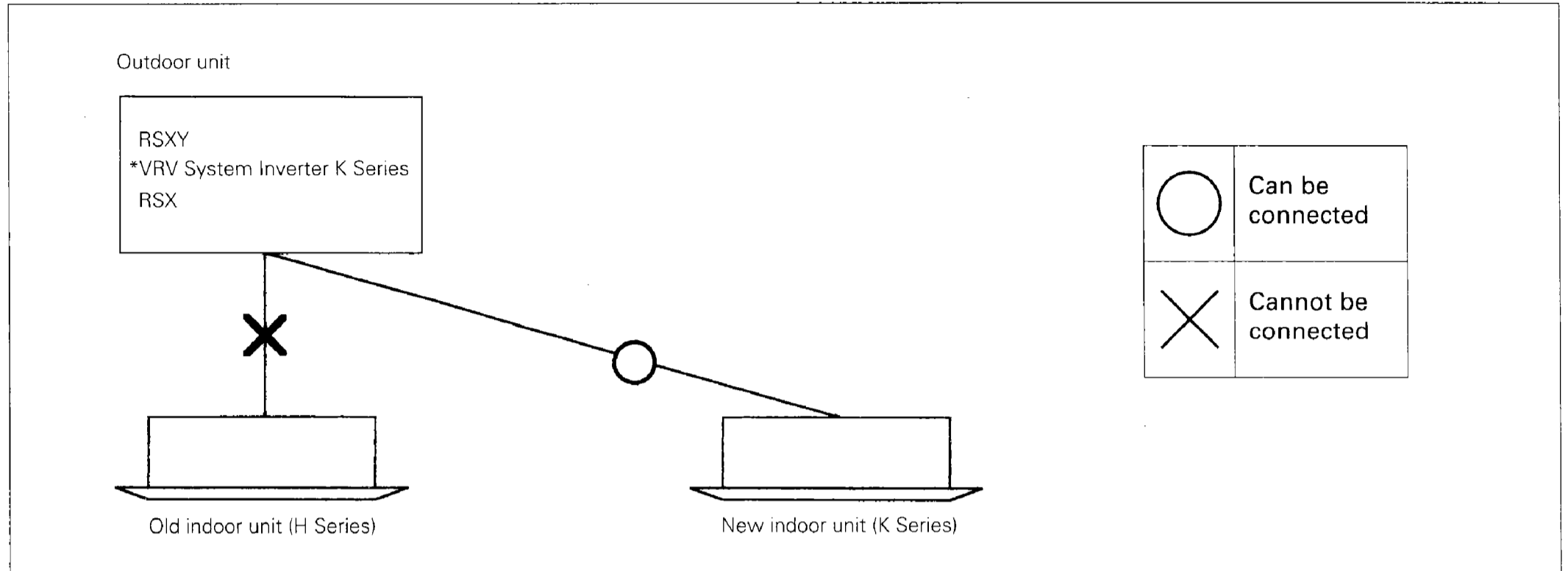

##### ■ Notes

1. Old and new indoor units cannot be used together.

#### (2) The new K Series indoor unit can be connected as an extension to an existing outdoor unit using an optional accessory "Mix Matching Adaptor "K" Indoor Unit"

##### ■ Connectable combinations

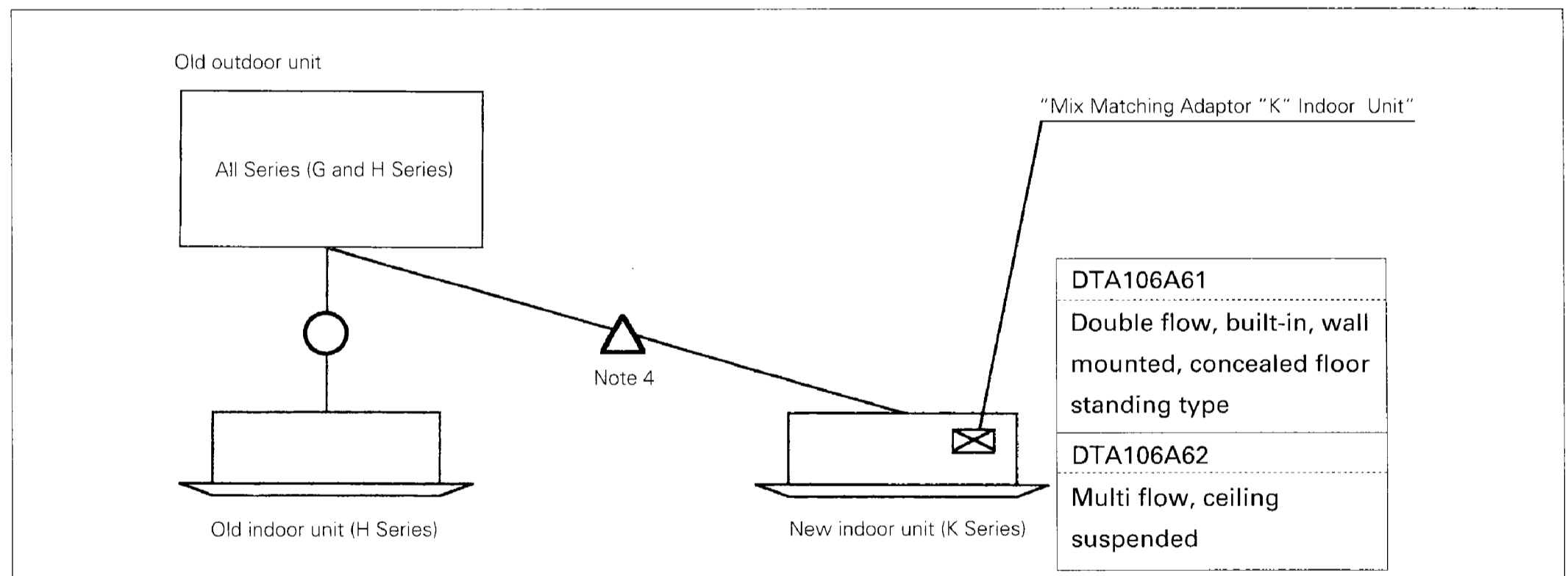

##### ■ Notes

3. Old and new indoor units can be used together.

4. An Mix Matching Adaptor for "K" Indoor Unit (DTA106A61/62) is required for one refrigerant system.

**MEMO**

# **FUNCTIONS**

## **Inverter K Series**

# 1. Outdoor Unit Refrigerant System Diagram

RSXY5K

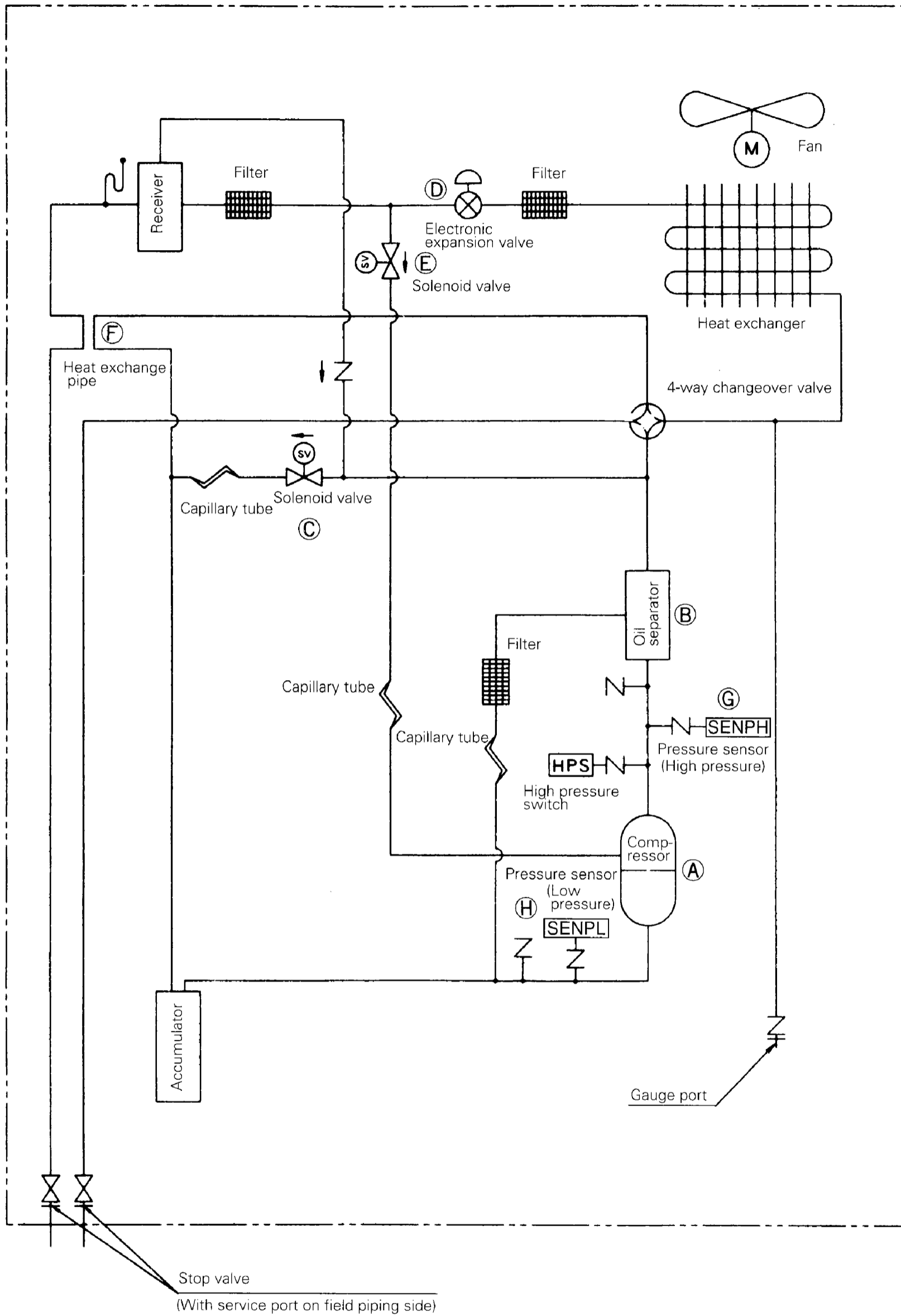



### **A. Compressor M1C**

Scroll compressor that operates on 30 ~ 116Hz by inverter drive enables 13-step capacity control. Capacity control is carried out for individual and linear control of indoor units.

### **B. Oil separator**

The oil separator is a device that collects the oil discharged from the compressor.  
The collected oil is constantly recycled to the compressor via capillary tube.

### **C. Solenoid valve (hot gas bypass) Y2S**

Valve is opened by low pressure safety control when low pressure drops.  
Balances high/low pressure when off in order to reduce load when the compressor starts.

### **D. Outdoor unit electronic expansion valve Y1E**

Expansion valve when heating. Senses compressor suction pipe and low pressure equivalent saturated temperature, and carries out superheat degree control.

### **E. Solenoid valve (injection) Y3S**

Controls injection in order to prevent overheating.

### **F. Heat exchange pipe**

Subcools so that refrigerant drift doesn't occur between indoor units when flash gas is produced in the liquid pipe.

### **G. Pressure sensor (high pressure, red) SENPH**

Semiconductor pressure sensor for sensing the operating status of the indoor by refrigerant pressure which senses discharge pressure.

### **H. Pressure sensor (low pressure, blue) SENPL**

Semiconductor pressure sensor for sensing the operating status of the indoor by refrigerant pressure which senses suction pressure.

# RSXY8,10K

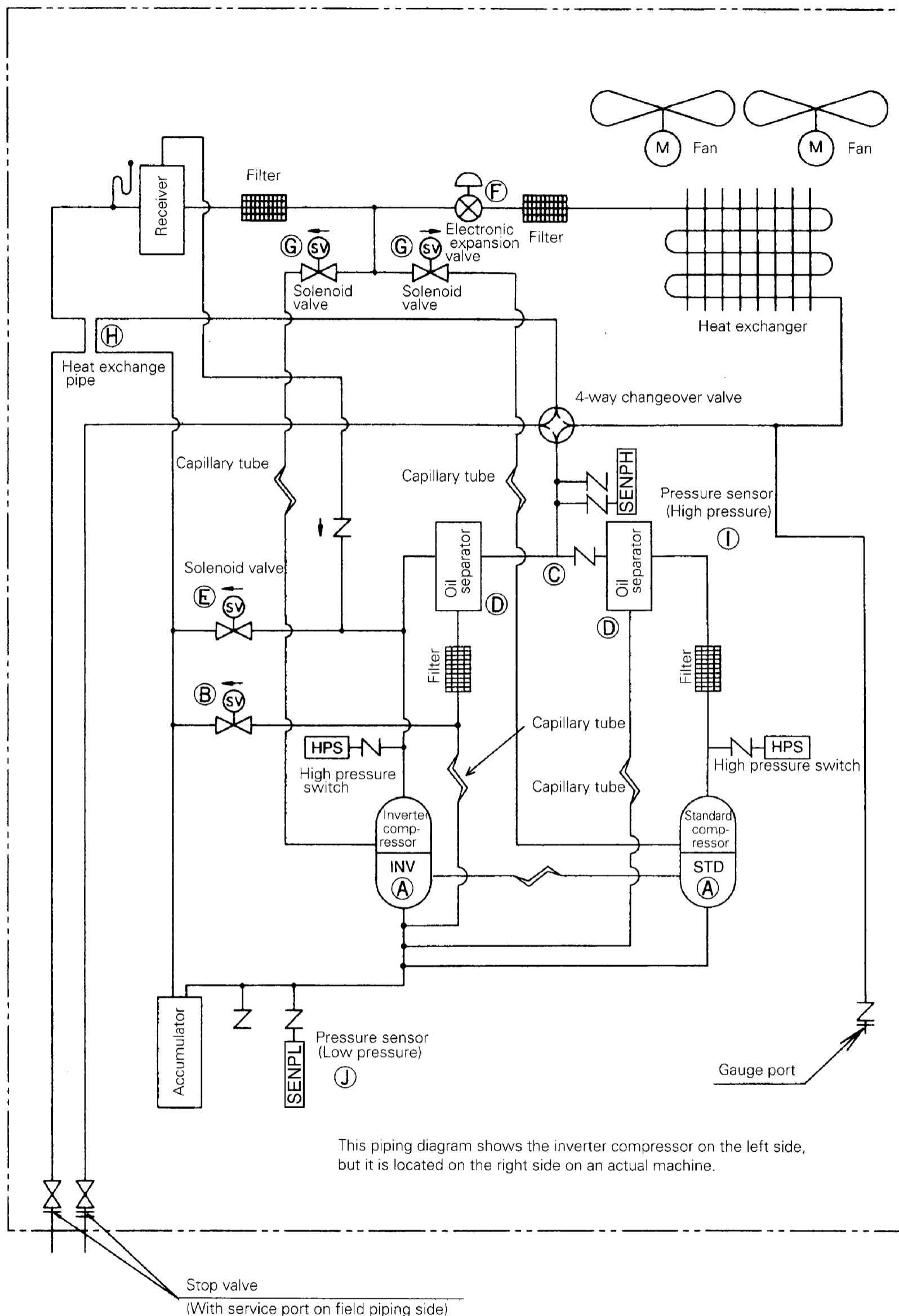

#### **A. Compressor M1C / M2C**

Connecting a scroll compressor (inverter compressor) that operates on 30 ~ 116Hz by inverter drive and a scroll compressor (standard compressor) that runs on a commercial power supply to the same refrigerant system enables 21-step capacity control. Capacity control is carried out for individual and linear control of indoor units.

(M1C: Inverter compressor, M2C: Standard compressor)

#### **B. Solenoid valve (pressure equalizing) Y1S**

Balances high/low pressure when off in order to reduce load when the compressor starts.

#### **C. Check valve**

Keeps liquid refrigerant from collecting in the standard compressor when only the inverter compressor is running.

#### **D. Oil separator**

The oil separator is a device that collects the oil discharged from the compressor. The collected oil is constantly recycled to the compressor via capillary tube.

#### **E. Solenoid valve (hot gas bypass) Y2S**

Valve is opened by low pressure safety control when low pressure drops.

#### **F. Outdoor unit electronic expansion valve Y1E**

Expansion valve when heating. Senses compressor suction pipe and low pressure equivalent saturated temperature, and carries out superheat degree control.

#### **G. Solenoid valve (injection) Y3S / Y4S**

Controls injection in order to prevent overheating.

Y3S: Inverter compressor, Y4S: Standard compressor)

#### **H. Heat exchange pipe**

Subcools so that refrigerant drift doesn't occur between indoor units when flash gas is produced in the liquid pipe.

#### **I. Pressure sensor (high pressure, red) SENPH**

Semiconductor pressure sensor for sensing the operating status of the indoor by refrigerant pressure which senses discharge pressure.

#### **J. Pressure sensor (low pressure, blue) SENPL**

Semiconductor pressure sensor for sensing the operating status of the indoor by refrigerant pressure which senses suction pressure.

## 2. Function of Thermistors and Pressure Sensors

■ Outdoor unit  
RSXY8, 10K

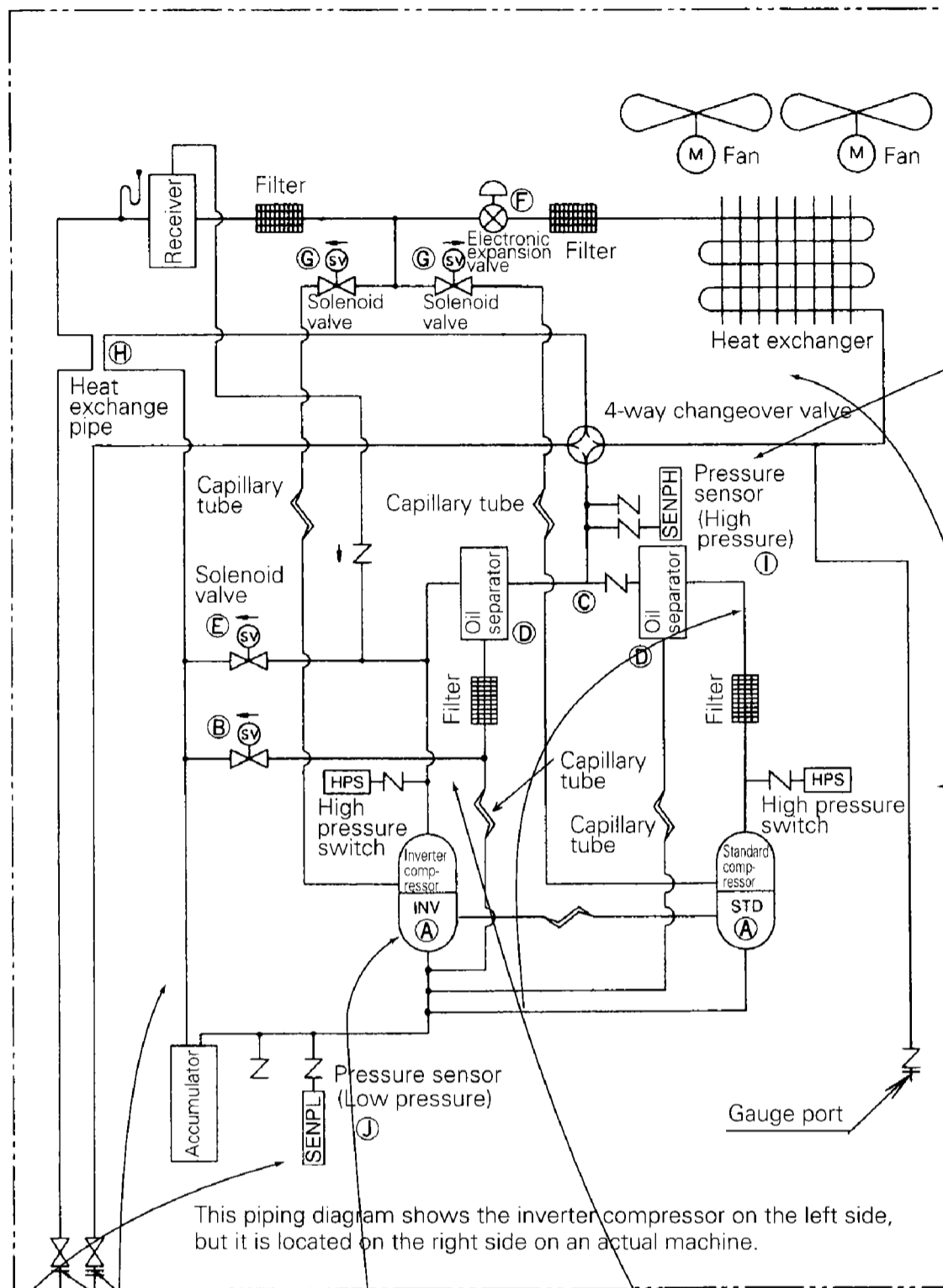

### High pressure sensor (SENPH)

When heating:

Used for compressor capacity control by sensing high pressure.

When cooling:

Carries out heat exchange control during low outdoor air cooling.

### Outdoor temperature thermistor (R1T)

(When heating)

- Used as the function for defrost IN conditions.
- OFF by thermostat when temperature becomes 27°C or higher

### Coil temperature thermistor (R2T)

(When cooling)

Not used for anything.

(When heating)

Used together with outdoor temperature as the function for defrost IN conditions.

### Suction pipe temperature thermistor (R4T)

Used for superheat control of electronic expansion valve when heating.

### Discharge pipe temperature thermistor

**R3-1T** (Inverter compressor)  
**R3-2T** (Standard compressor)  
Used for compressor discharge temperature safety.  
(RSXY5K R3T)

### Oil temperature thermistor (R5T)

(8, 10 HP only)  
(When heating)

- Alters the desired superheat degree (SH) to prevent wet operation.

(When defrosting)

- Controls upper limit frequency to improve dilution of oil.

### Low pressure sensor (SENPL)

When heating:

Used for compressor capacity control and low pressure safety control by sensing high pressure.

When cooling:

Used for overheating control and low pressure safety control.

This piping diagram shows the inverter compressor on the left side, but it is located on the right side on an actual machine.

Stop valve  
(With service port on field piping side)

### 3. List of Safety Devices and Functional Parts Setting Values

#### Outdoor unit RSXY5~10K

Item	Symbol	Name		Type									
				RSXY5K		RSXY8K		RSXY10K					
Compressor		Inverter side Model Output	Y1	JT100BAVYE	3.5 kW	JT100BAVYE	3.5 kW	JT100BAVYE	3.5 kW	JT100BATYE	2.2 kW	JT160BATYE	3.75kW
			YAL	JT100BAVYE	3.5 kW	JT100BAVYE	3.5 kW	JT100BATYH	2.2 kW	JT100BAVTYE	3.5 kW	JT160BATYH	3.75kW
			TAL	JT100BAV	3.5 kW	JT100BAVT	3.5 kW	JT100BAT	2.2 kW	JT100BAVT	3.5 kW	JT160BAT	3.75kW
		Standard side		————		JT100BAT	2.2 kW		JT160BAT	3.75 kW			
		Compressor safety thermostat				Discharge pipe thermistor 135°C OFF							
	J1HC/J2HC	Crank case heater		33W		33W+33W							
	F2C	Over-current relay	Y1		————		HOE-20F-TRA1	10A		HOE-20F-TRA1	13A		
			YAL		————		HOE-20F-TRA1	10A		HOE-20F-TRA1	13A		
			TAL		————		HOE-20-TRA1	15A		HOE-26-TRA1	24A		
	Safety device	Q1M	Fan motor		190W		140W+230W						
Q2M		Safety thermostat		Open 135°C±5°C		140 W: Open 120 ± 5°C, 230 W: 135 ± 5°C							
S1P		Pressure switch (for high pressure safety)		20SP-688-6 OFF:27.5+0~-1.0kg/cm <sup>2</sup> ON:20.0+1.0~-1.0kg/cm <sup>2</sup>		————							
S1HP		Pressure switch (for high pressure safety)		————		20SP - 688 - 6 OFF:27.5+0~-1.0kg/cm <sup>2</sup> ON:20.0+1.0~-1.0kg/cm <sup>2</sup>							
S2HP		Pressure switch (for high pressure safety)		————		20SP - 688 - 6 OFF:27.5+0~-1.0kg/cm <sup>2</sup> ON:20.0+1.0~-1.0kg/cm <sup>2</sup>							
		Fusible plug				FPG-3D 70~75°C							
Sensor	SENP	Pressure sensor				PS8030A 0~30kg/cm <sup>2</sup> (0~2.94MPa)							
	SENP	Pressure sensor				PS8030A 0~10kg/cm <sup>2</sup> (0~0.98MPa)							
	R1T	Thermistor (for outdoor air)				3.5~360KΩ							
	R2T	Thermistor (for heat exchange)				3.5~360KΩ							
	R3T	Thermistor (for discharge pipe)		3.5~400KΩ		————							
	R3-1T	Thermistor (for inverter discharge pipe)		————		3.5~400KΩ							
	R3-2T	Thermistor (for standard discharge pipe)		————		3.5~400KΩ							
	R4T	Thermistor (for suction pipe)				3.5~360KΩ							
	R5T	Thermistor (for inverter oil temperature)		————		3.5~400KΩ							
Other functions /parts	Y1E	Electronic expansion valve	When cooling	ON: 2,000 pulses (completely open); OFF: 0 pulses (completely closed)									
			When heating	ON: PI control; OFF: 0 pulses (completely closed)									
	Y2S	Solenoid valve (for hot gas bypass)			NEV603								
	Y3S	Solenoid valve (for auxiliary condenser)			NEV202								
	Y4S	Solenoid valve (for inverter injection)		————		NEV202							
Y1S	Solenoid valve (for standard injection)		————		NEV202								

## 4. Safety for Restart

### (1) Restart Safety Timer

When operation is turned off by thermostat sensor, the compressor will not run for five minutes in order to prevent it from being turned on and off in rapid succession, and to equalize pressure in the refrigerant circuit. It however restarts automatically after five minutes passes and operation is restarted by thermostat. The pressure equalizing solenoid valve is actuated for 10 minutes (15 minutes for 8 and 10HP heating only) after the compressor stops in order to equalize pressure.

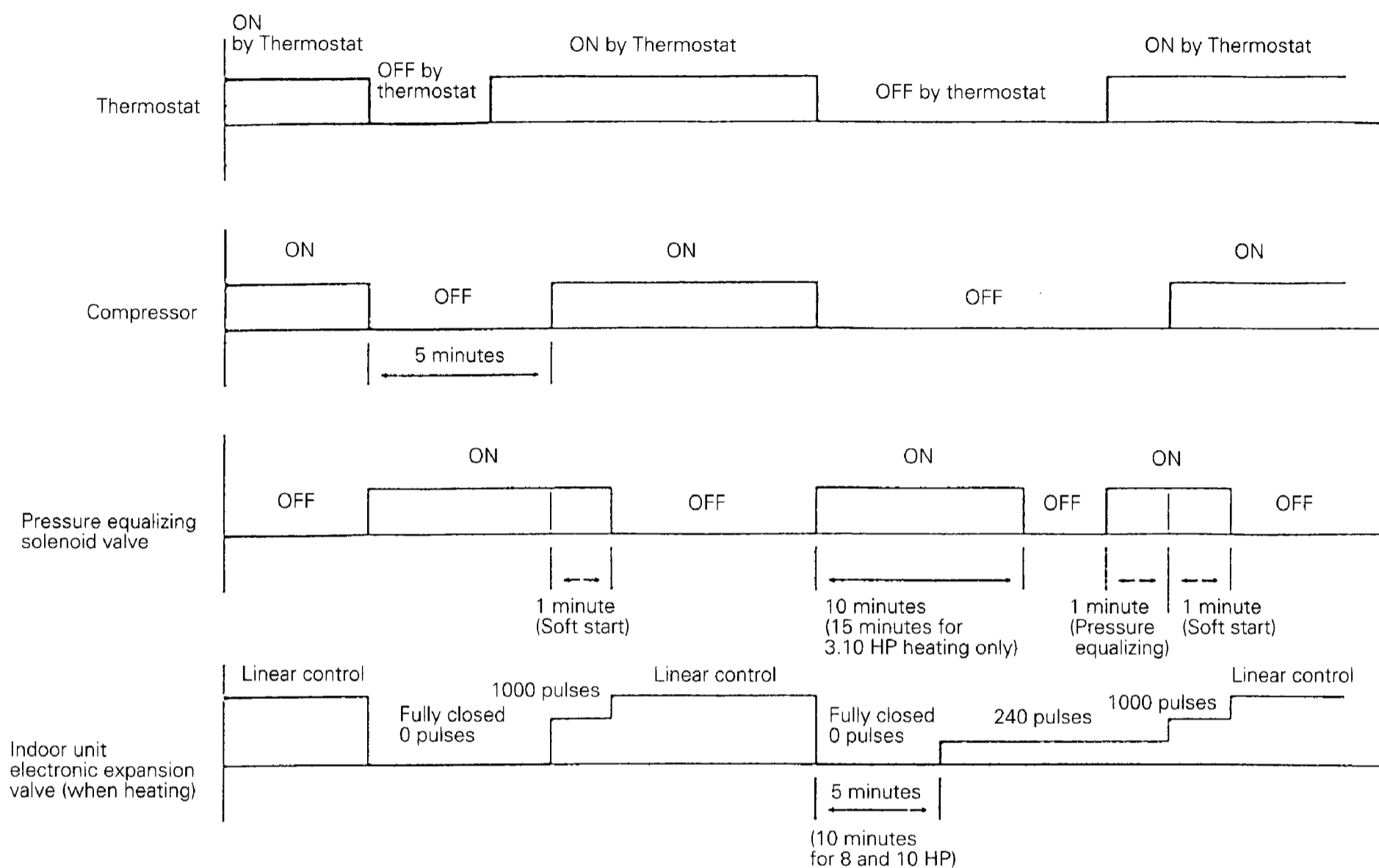

If 10 minutes or more has elapsed since the compressor was turned off (15 minutes for 8 and 10HP heating only), turn the solenoid valve for equalizing pressure on for about 1 minute and equalize the pressure.

When heating, to prevent noise produced by the passing of indoor unit's refrigerant to equalize pressure after the compressor stops, fully close the indoor unit's electronic expansion valve for 5 minutes (10 minutes for 8 and 10HP).

## (2) Soft Start

The following control is carried out to protect the compressor and inverter.

- (1) Operates at low frequency (fixed) for 1 minute after compressor starts. (Prevents backflow)
- (2) Pressure equalizing and hot gas bypass solenoid valves open and start low load.

Soft start of compressor

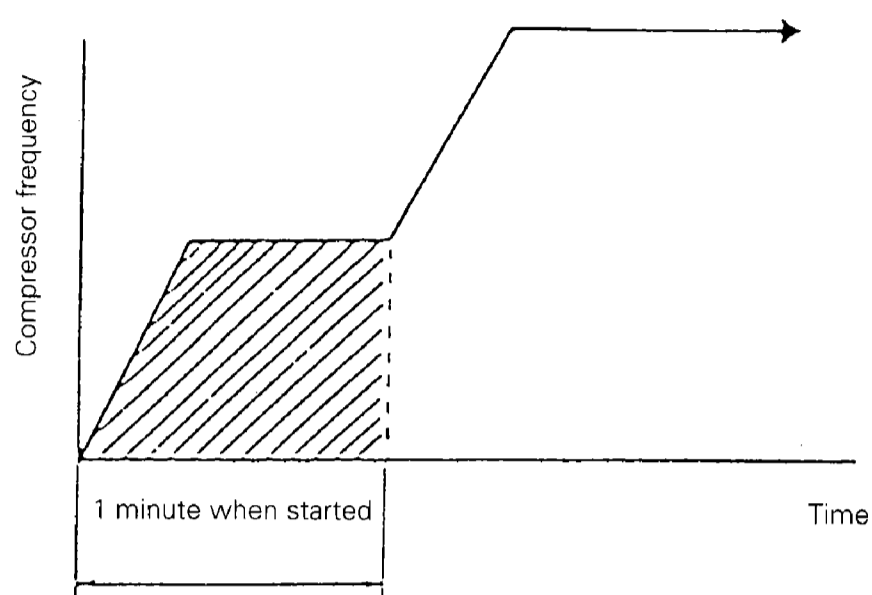

	Frequency during soft start
5K	42Hz
8,10K	42Hz+OFF

## (3) Pump Down Start

If the compressor stops running with refrigerant still in the accumulator, in order to prevent wet operation the next time you start the compressor, you should perform pump down start so you can start normal operation with a completely dry accumulator.

Pump down start should be performed if the unit is in any of the conditions given below when pressure equalizing control has been completed before start.

If R3T (R3-1T) is less than 95°C and the unit is in any of the following conditions.

- Within 10 minutes of the compressor starting
- Defrosting or during oil return
- Within 20 minutes of completion of defrost or oil return
- Outdoor air temperature is less than -5°C

### Operation during pump down start

	11 min. 30 sec.				
	1 min.	5 min.	30 sec.	30 sec.	4 min. 30 sec.
Compressor	42Hz (42Hz+OFF)	42Hz (42Hz+OFF)	42Hz (42Hz+OFF)		PI control ※(initial 30 Hz, upper 16Hz [116Hz + OFF])
Outdoor unit EV	0 pulses	0 pulses	0 pulses		SH control (Initial opening 150 pulses)
Outdoor unit fan	H tap (H+ON)	H tap (H+ON)	H tap (H+ON)		H tap (H+ON)
Y2S	ON	ON	ON	OFF	ON/OFF (Td protection control)
Y3S, Y4S	ON	ON/OFF (Td protection control)	ON/OFF (Td protection control)		ON/OFF (Td protection control)

※When heating, low pressure < 0.8 Kg/cm<sup>2</sup> (0.147MPa) → running frequency 54Hz (54Hz + OFF)

Low pressure > 1.1 Kg/cm<sup>2</sup> (0.167MPa) [30 sec. continuous] → release

- Y2S: Hot gas bypass solenoid valve
- Y3S: Injection solenoid valve

#### (4) Heating Lay-Up Start

If the compressor hasn't run for a long time and the refrigerant isn't circulated, foaming could cause a lack of oil when the compressor is started the next time. You should therefore perform heating lay-up start to keep the low pressure from dropping too low in the following cases.

- When, after being started, the accumulated running time of the compressor does not exceed one hour.
- When the compressor has been stopped for more than 24 hours.

Operation during heating lay-up start

Make the compressor's upper limit frequency 60Hz (60Hz + OFF) for 10 minutes 20 seconds after the compressor starts.

※If the low pressure becomes less than 1.5Kg/cm<sup>2</sup> (0.147MPa) within 10 minutes after starting, Y2S is actuated and outdoor unit EV becomes 0 pulses. 10 minutes after start, the unit starts up as described below.

4 min. 30 sec.	
Compressor	PI control (upper limit 116Hz [116Hz +OFF])☆
Outdoor unit EV	SH control (initial opening 150 pulses)
Outdoor unit fan	H tap (H+ON)
20RP	ON/OFF (LP safety control)
20RT	ON/OFF (Td safety control)

• Y2S: Hot gas bypass solenoid valve

• Y3S: Injection solenoid valve

☆If low pressure becomes less than 0.8 Kg/cm<sup>2</sup> (0.147MPa), operating frequency becomes 54Hz.

If low pressure becomes less than 1.1 Kg/cm<sup>2</sup> (0.167MPa), the solenoid valves are released.

### 5. Equalized Oil Level Operation

#### (equalized oil level between twin compressors)

If using two compressors (8, 10Hp) connected in parallel, oil level equalizing is carried out for 5 minutes if the cumulative running time of the standard compressor exceeds 2 hours in order to prevent lack of oil cause by difference in pressure inside the dome due to drift, and then reverts to normal operation.

Inverter compressor	Standard compressor
106Hz	OFF

※If oil pressure equalization is stopped or is not achieved during 5 minutes of step down control, oil pressure is equalized when the compressor starts running.

With an inverter compressor, however, if the standard compressor remains off for 10 minutes, the cumulative running time of the standard compressor is reset.



## 6. Oil Return Operation

In order to collect refrigeration oil held up in connecting piping, the compressor's operating time is counted, and oil return operation is carried out for 4 minutes every 8 hours (2 hour after turning on the power supply, and every 8 hours after that). (When heating, the indoor unit's electric heater is tuned off one minute prior to oil return in preparation for oil return.)

### (1) Compressor Operation Frequency

Type	Cool	Heat
5K(5HP)	106Hz	96Hz
8K(8HP)	106Hz+ON	86Hz+ON
10K(10HP)	106Hz+ON	86Hz+ON

- When heating, frequency is lower than that given in the table for the first 30 seconds and 30 seconds after completion.
- Frequency may drop according to the various types of step-down control. If so, the next oil return must be carried out 4 hours later.

### (2) Opening of the electronic expansion valve

	Outdoor unit	Operating indoor unit	Indoor unit turned off
When cooling	2000 pulses (completely open)	2000 pulses (completely open)	1440 pulses
When heating	2000 pulses (completely open)	2000 pulses (completely open)	2000 pulses (completely open)

### (3) 4-way changeover valve (Y1R)

When cooling: No change

When heating: Switches to cooling mode

### (4) Fan and solenoid valve

Step No. changes according to high pressure.

Step No.	Y2S	Y3S, Y4S	Fan
①	ON※	ON	H(H+ON)
②	OFF☆	ON	L(H+OFF)
③	OFF☆	ON	OFF

(Step No. becomes higher as high pressure decreases.)

① → ② 30 sec. after oil return start or high pressure is less than 16Kg/cm<sup>2</sup> (1.57MPa)

② → ③ High pressure is less than 7.5 Kg/cm<sup>2</sup> (0.74MPa)

③ → ② High pressure is greater than 15 Kg/cm<sup>2</sup> (1.47MPa)

② → ① High pressure is greater than 20 Kg/cm<sup>2</sup> (1.96MPa)

※When heating only

☆ On when low pressure is less than 0.3 Kg/cm<sup>2</sup> (0.029MPa)

Off when low pressure is greater than 0.8 Kg/cm<sup>2</sup> (0.078MPa)

Notes)

1. If the compressor frequency continues at 68Hz (38Hz + ON for 8, 10HP) or more for eight minutes or more while defrosting and the oil return timer is counting, the timer is reset and counts again for eight hours.
2. If on standby (forced OFF by thermostat) or the compressor stops due to malfunction during oil return operation, the next time the compressor starts, oil return operation is again carried out for four minutes after completion of soft start.
3. Oil return operation is not carried out for 28 minutes after defrost is completed.

## 7. Defrost

### • Function

Defrost operation is carried out if the relation of the outdoor unit's coil temperature ( $T_{coil}$ ) and outdoor temperature ( $T_{air}$ ) satisfies the conditions given below for 5 minutes continuously.

$$T_{coil} \leq C \cdot T_{air} - \alpha$$

- $T_{coil}$  : Temperature detected by R2T
- $T_{air}$  : Temperature detected by R1T
- $C$  :  $T_{air} < 0^{\circ}\text{C} \rightarrow 0.8$   
 $T_{air} \geq 0^{\circ}\text{C} \rightarrow 0.6$

The values of (a) according to defrost temperature changeover switch are given in the table below.

Switch position LED(23 24 25 26)	L ( ● ● ● ○ )	M ( ● ● ○ ● )	H ( ● ○ ● ● )
(deg)	12	10	8

Therefore, if outdoor temperature is  $0^{\circ}\text{C}$ :

(1) If position L,  $T_{coil} \leq -12^{\circ}\text{C}$

(2) If position M,  $T_{coil} \leq -10^{\circ}\text{C}$

(3) If position H,  $T_{coil} \leq -8^{\circ}\text{C}$

Because defrost operation is carried out, set to the "H" position if frost builds up easily, and set to "L" if not.

Factory set is position "M."

Defrost is carried out when the coil temperature rises to  $12.5^{\circ}\text{C}$  or higher, and is completed after defrosting for 10 minutes. After defrosting, indoor units carry out hot start operation and the DEFROSTING display lights until hot start is complete.

Defrost conditions are not counted from completion of power supply set-up and defrost until the compressor runs (count) for 20 minutes.

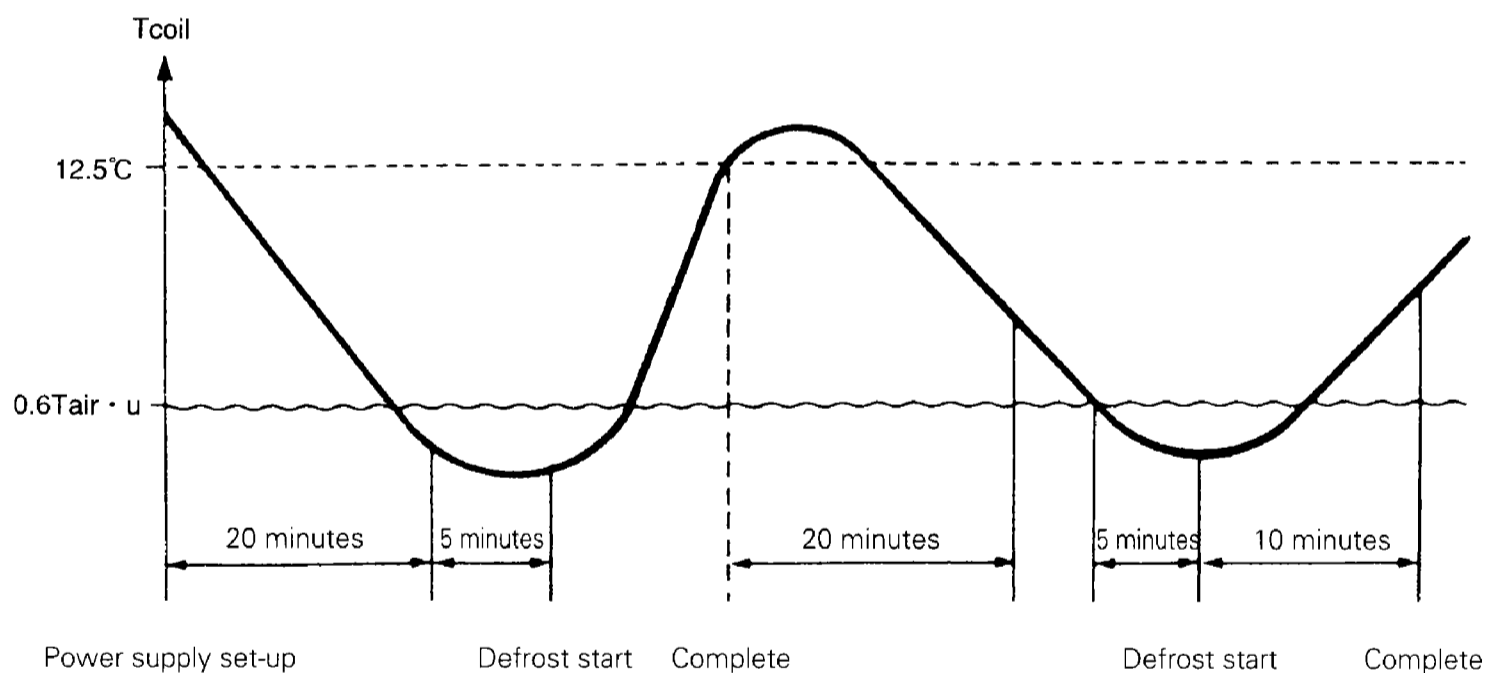

## 8. Heating Pump Down Residual Operation

### (For RSXY 8, 10 K)

Residual operation may be carried out for 10 minutes under the following conditions when heating.

- (1) When outdoor temperature (R1T) is greater than or equal to  $-5^{\circ}\text{C}$  and inverter discharge pipe temperature (R3-1T) is less than  $95^{\circ}$ , and a OFF by thermostat command is received with the compressor's continuous operation time being 10 minutes or less, residual operation is carried out for a maximum of 10 minutes.

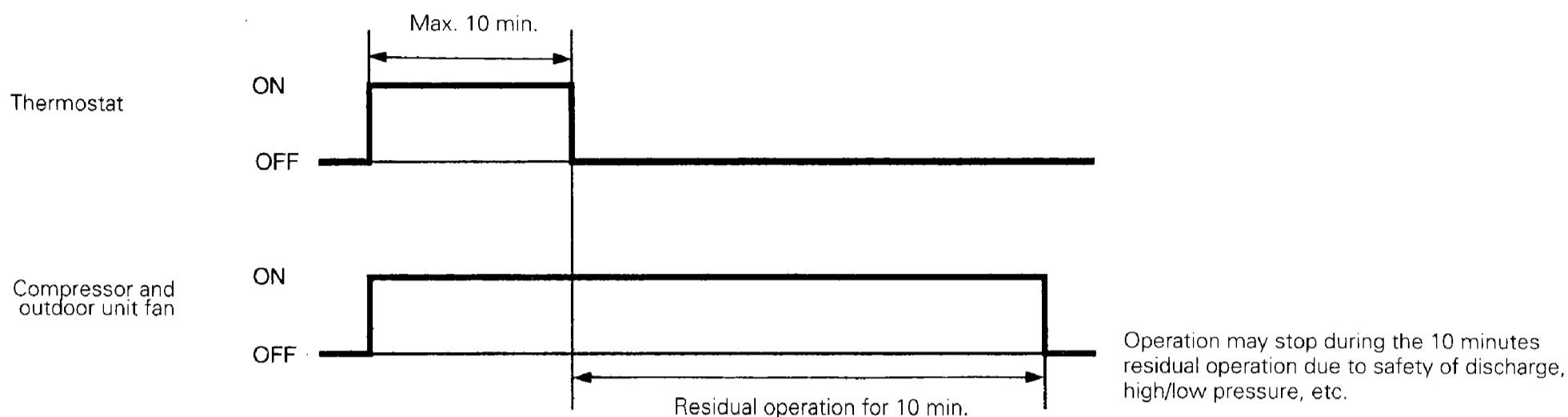

- (2) When the thermostat is ON during residual operation, residual operation is not carried out if the total of (1) + (2) + (3) is 10 minutes or more.

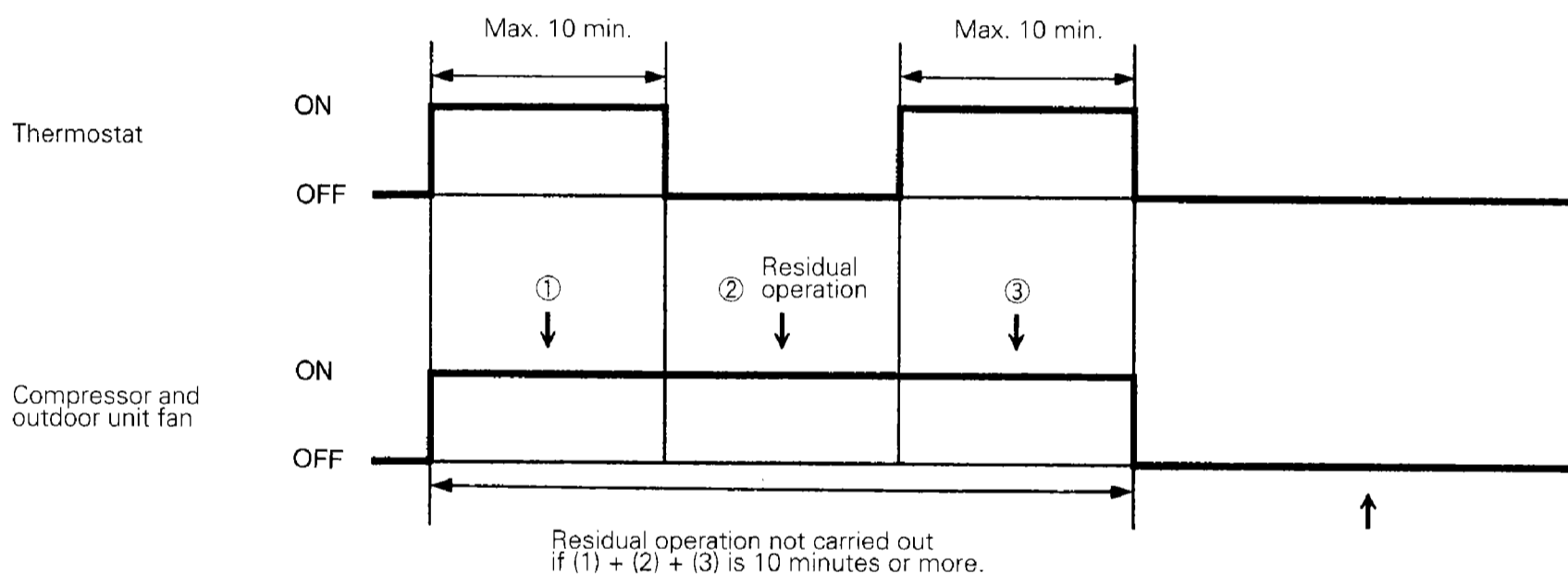

- (3) When outdoor temperature (R1T) is less than  $-5^{\circ}\text{C}$  and a stop command is received from the thermostat sensor, etc., residual operation is carried out for 10 minutes without fail. (Operation may however stop for discharge pipe or high/low pressure safety.)

### Outdoor unit function

Outdoor air (Th1)	Compressor	Electronic expansion valve	Pressure equalizing solenoid valve	Time
Less than $\sim 10^{\circ}\text{C}$	86Hz+OFF	0 ~ 300 pulses	ON or OFF	10 min.
Less than $0^{\circ}\text{C}$	76Hz+OFF	0 ~ 300 pulses	ON or OFF	10 min.
$0^{\circ}\text{C}$ or higher	60Hz+OFF	0 ~ 300 pulses	ON or OFF	10 min.

### Notes)

- Compressor upper limit is 116Hz + OFF for 10 minutes of next start after entering residual operation.
- During defrost or oil return, residual operation is not carried out even if a stop command comes.
- Forced OFF by thermostat occurs if defrost or oil return comes during residual operation.

## 9. Step Down / Safety Control → Standby (Forced Thermostat OFF) → Stop Due to Malfunction

### (1) High pressure (Hp) control



### (2) Low pressure (Lp) control

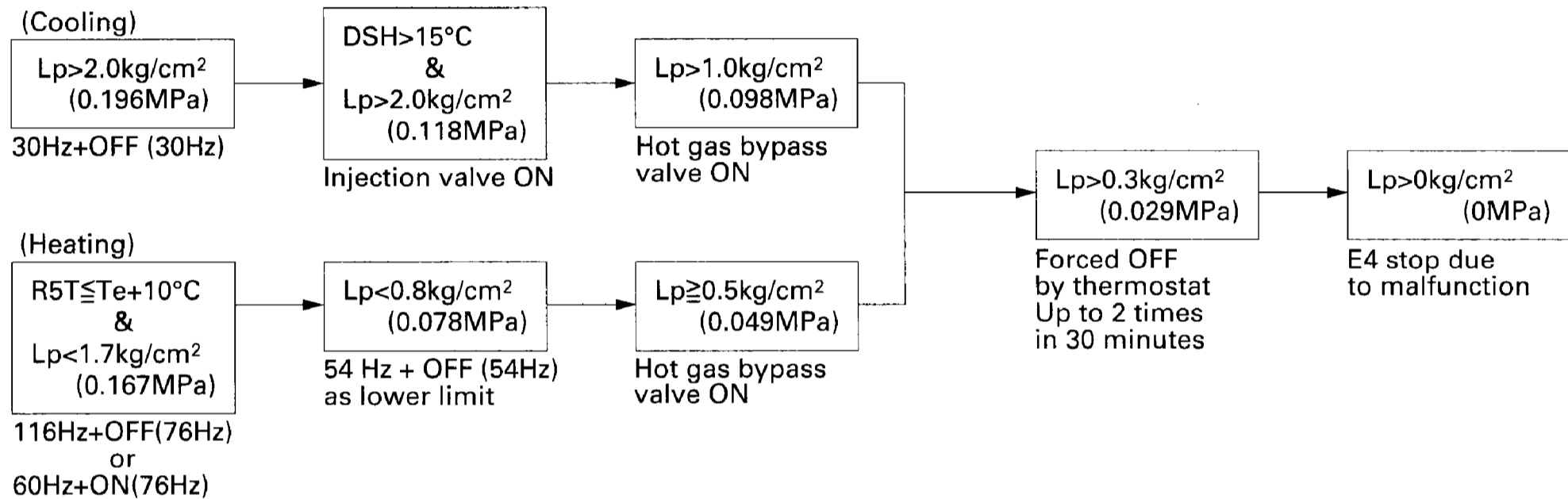

### (3) Discharge pipe temperature (Td) control

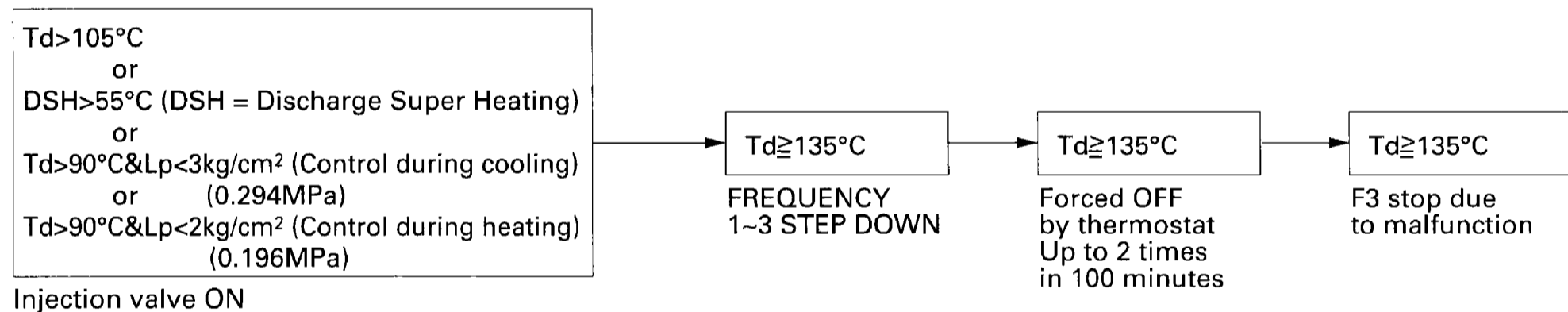

### (4) Inverter current control

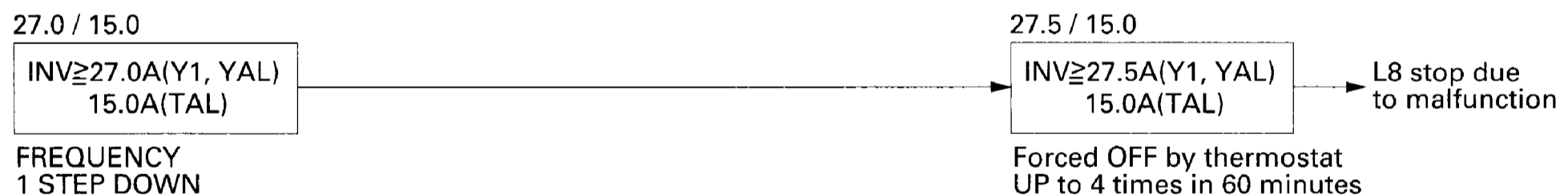

### (5) Discharge super heating (DSH) control

(DSH =  $T_d$  - high pressure condensation saturation temperature)

When both the inverter and standard compressors are running, if the injection valve for either one goes OFF, and super heating (DSH) continues for 10 minutes at temperature difference of less than 10°C, and the inverter compressor is controlled at 76 Hz or less for 3 minutes.

### (6) Control according to outdoor temperature

If the outdoor temperature exceeds 27°C when heating, forced OFF by thermostat is carried out in order to prevent a safety device from being tripped or a sensor malfunction.

## 10. Control During Low Outdoor Air Temperature Cooling

- When cooling when the outdoor air temperature is low in cooling, outdoor unit fans, electronic expansion valve and compressors are controlled as follows in order to primarily maintain high pressure and to check drop in refrigerant circulation caused by drop in high pressure.

### RSXY5K

Operating status		Electronic expansion valve	Fan	Frequency (Hz)
Normal operation		Completely open	H	Changes according to operating status
Low outdoor temperature cooling operation	Step 1	Completely open	L	76
	Step 2	Completely open	OFF	48

### RSXY8,10K

Operating status		Electronic expansion valve	Fan		Frequency (Hz)	
			M1F	M2F	8K	10K
Normal operation		Completely open	H	ON	Changes according to operating status	
Low outdoor temperature cooling operation	Step 1	Completely open	L	ON	96	116
	Step 2	Completely open	H	OFF	86	106
	Step 1-3	Completely open	L	OFF	76	96
	Step 2	Completely open	OFF	OFF	60	76

NOTE: Step No. changes according to high pressure, low pressure and frequency.  
(Step No. increases with high pressure and reduction of low pressure.)

#### • Low outdoor air cooling IN conditions (Steps 1-1, 2, 3)

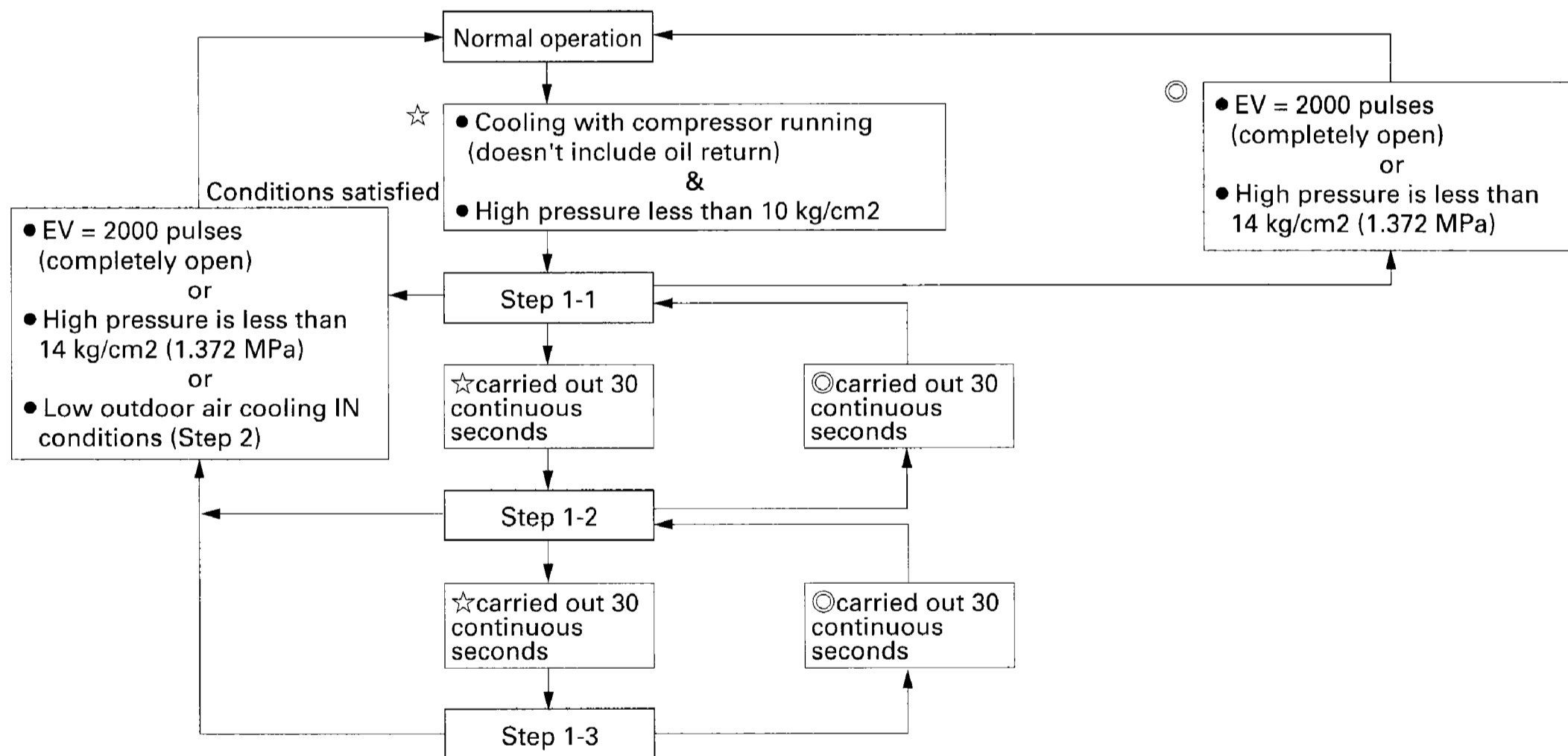

#### • Low outdoor air cooling IN conditions (Step 2)

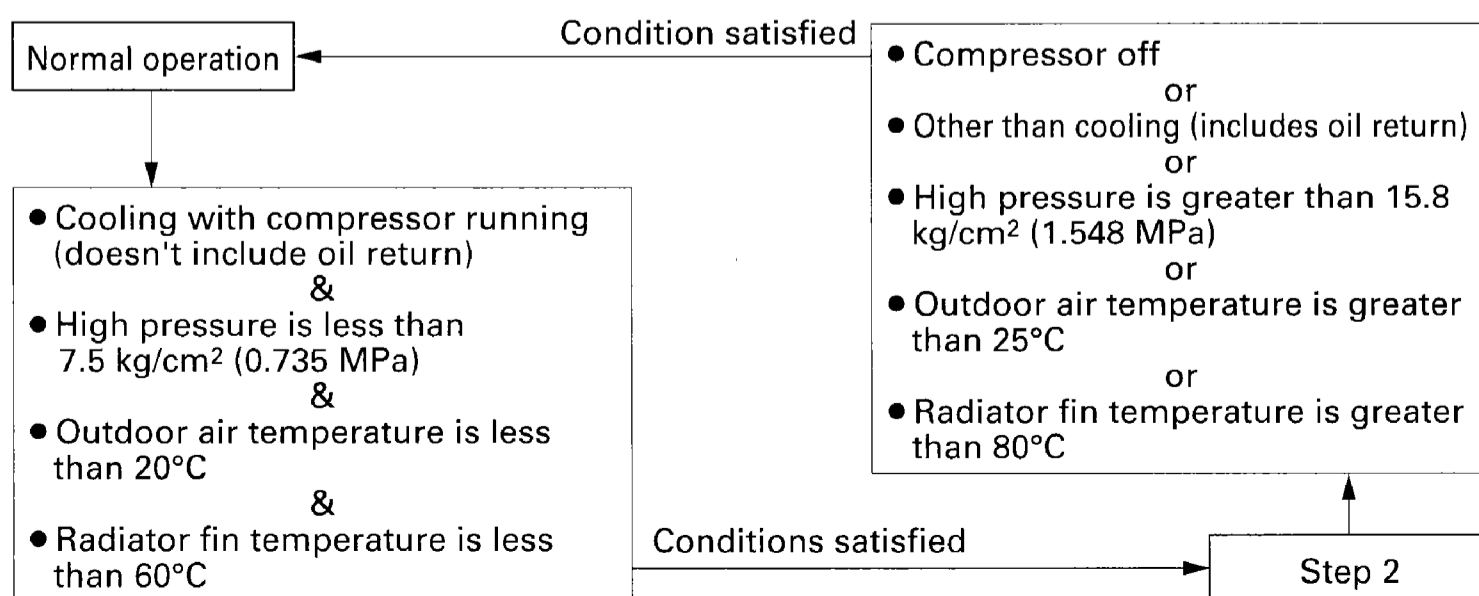

## 11. Low Noise Control

If sound produced by outdoor units is a problem at night, etc., you can reduce the running noise by 2 to 3 dB by running the outdoor unit fans and compressors at low speed via contact input (low noise input) from outside. Operation (contact short circuit) is as follows when low noise input is received while the compressor is running (except when defrosting or oil return is being carried out).

		5k (5,HP)	8K (8HP)	10K (10HP)
Outdoor unit fan	step ①	L tap	H tap + OFF	
	step ②	L tap	L tap + OFF	
Compressor		60Hz	86Hz+OFF	96Hz+OFF

- When cooling: Step (1) → (2) high pressure > 24 kg/cm<sup>2</sup> (2.35 MPa)  
Step (2) → (1) high pressure < 19 kg/cm<sup>2</sup> (1.86 MPa)
- Low noise control reduces capacity by limiting the fan and compressor. The load when heating is particularly large at night when the outdoor temperature is low, and could result in insufficient capacity.
- During low noise control, retry is unlimited for standby (forced OFF by thermostat) produced by high pressure, low pressure or discharge pipe temperature.
- An optional adaptor for outside control of outdoor units is required for low noise control. For method of connection, see low noise operation in the test operation section.

## 12. Demand Control

There are three modes of demand operation which controls forced capacity save for outdoor units via contact input (demand input) from outside in order to control demand.

- (1) Demand 1: Holds demand down to approx. 70%
- (2) Demand 2: Holds demand down to approx. 40%
- (3) Demand 3: Forced OFF by thermostat

- An optional adaptor for outside control of outdoor units is required for low noise control. For method of connection, see low noise operation in the test operation section.
- Control is carried out by limiting the upper limit for frequency of demand 1 and demand 2 as given in the table below.

	5HP	8HP	10HP
Demand 1	68Hz	48Hz+ON	60Hz+ON
Demand 2	34Hz	60Hz+OFF	76Hz+OFF
Demand 3	Forced OFF by thermostat		

# 13. Compressor Capacity Control

## 1. RSXY5K

Pressure is sampled every 20 seconds by pressure sensor, and the inverter compressor is controlled in 13 stages by microcomputer. Frequency range: 34 - 116 Hz (13 stages)

Frequency	Min. output
30Hz	↑ ↓ Max. output
34Hz	
38Hz	
42Hz	
48Hz	
54Hz	
60Hz	
68Hz	
76Hz	
86Hz	
96Hz	
106Hz	
116Hz	

## 2. RSXY8, 10K

Pressure is sampled every 20 seconds by two pressure sensors, and the inverter compressor is controlled in 21 stages by microcomputer.

Commercial power supply compressor (off)	Commercial power supply compressor (full load)	Min. output ↑ ↓ Max. output
Frequency	Frequency	
30Hz+OFF		
34Hz+OFF		
38Hz+OFF		
42Hz+OFF		
48Hz+OFF		
54Hz+OFF		
60Hz+OFF		
68Hz+OFF		
76Hz+OFF		
86Hz+OFF		
96Hz+OFF		
106Hz+OFF		
116Hz+OFF		
	38Hz+ON	
	48Hz+ON	
	60Hz+ON	
	76Hz+ON	
	86Hz+ON	
	96Hz+ON	
	106Hz+ON	
	116Hz+ON	

## 14. Te / Tc Setting

You can alter the value of setting mode 2 targets Te (evaporating pressure equivalent temperature) and Tc (condensing pressure equivalent temperature). PI control is used to control compressor capacity so that Te when cooling and Tc when heating are constant.

Te setting	Set temperature
High	8.5 °C
Standard	5.5 °C
Low	2.5 °C

- Target Te changes according to compressor operating frequency, length of piping and indoor load. The range is  $-10^{\circ}\text{C} \leq \text{target Te} \leq 5.5^{\circ}\text{C}$ . (Piping length is determined automatically during oil return operation.)

Tc setting	Set temperature
High	49 °C
Standard	46 °C
Low	43 °C

- Target Tc becomes 3°C higher when indoor load is large. Target Tc is controlled in accordance with the following conditions:
- Outdoor temp.  $> 10^{\circ}\text{C} \rightarrow \text{target Tc} \leq 46^{\circ}\text{C}$
- Outdoor temp.  $\leq 10^{\circ}\text{C} \rightarrow \text{target Tc} \leq 49^{\circ}\text{C}$
- Target Tc is 43°C when high pressure is greater than 17 kg/cm<sup>2</sup> (1.67 MPa) and low



## 15. Gas Depletion Alarm

An alarm (U0) is given for severe gas depletion. Alarm is indicated but operation continues.

(When cooling)

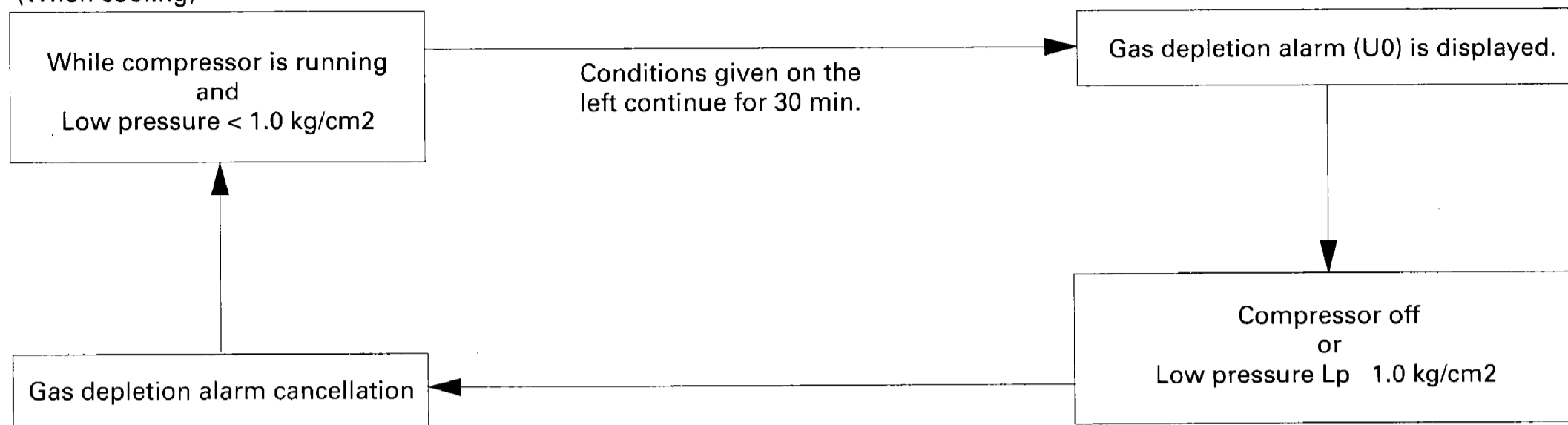

(When heating)

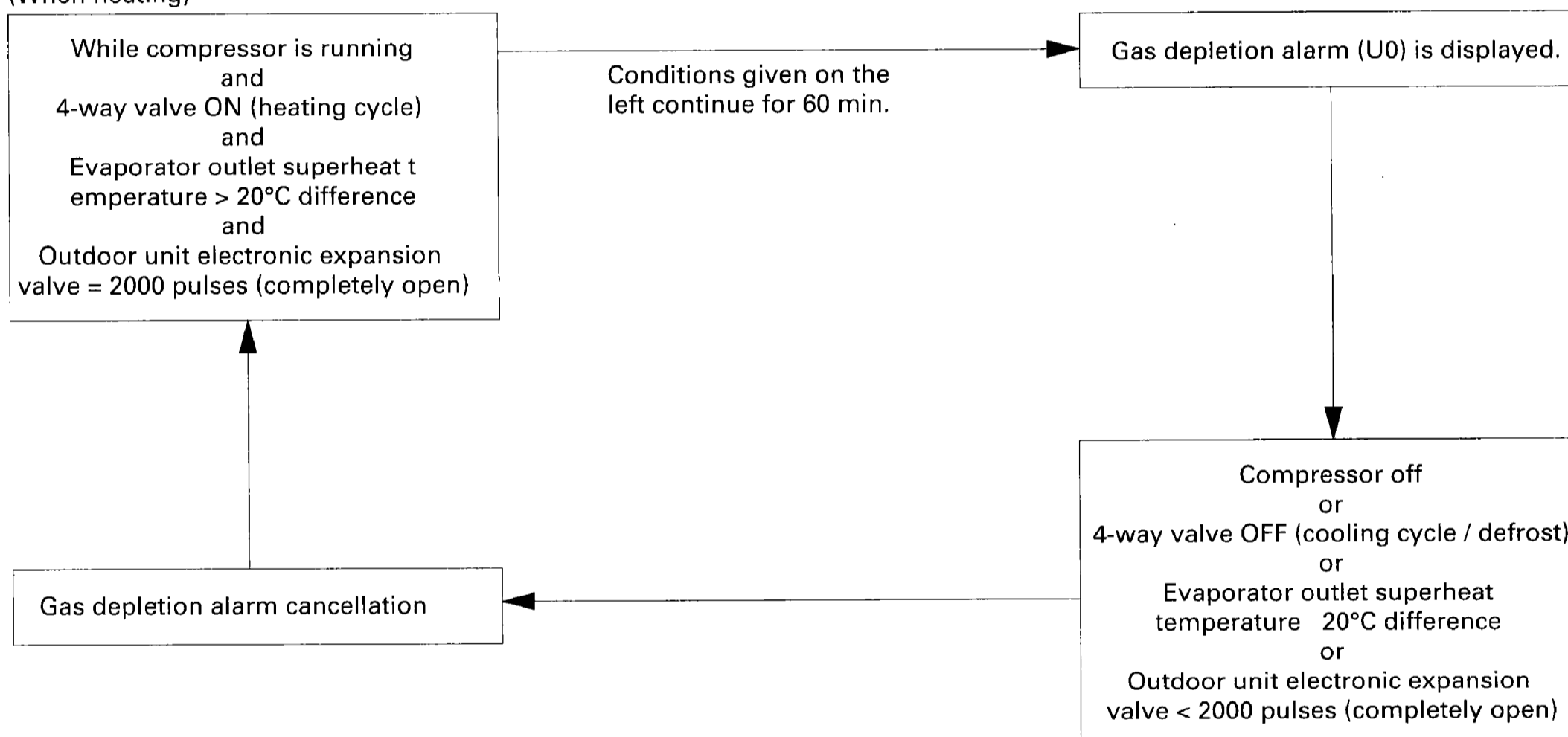

## 16. Drain Pump Control

1. The drain pump is controlled by the ON/OFF buttons (4 button (1) - (4) given in the figure below).

(1) When the float switch is tripped while the cooling thermostat is ON:

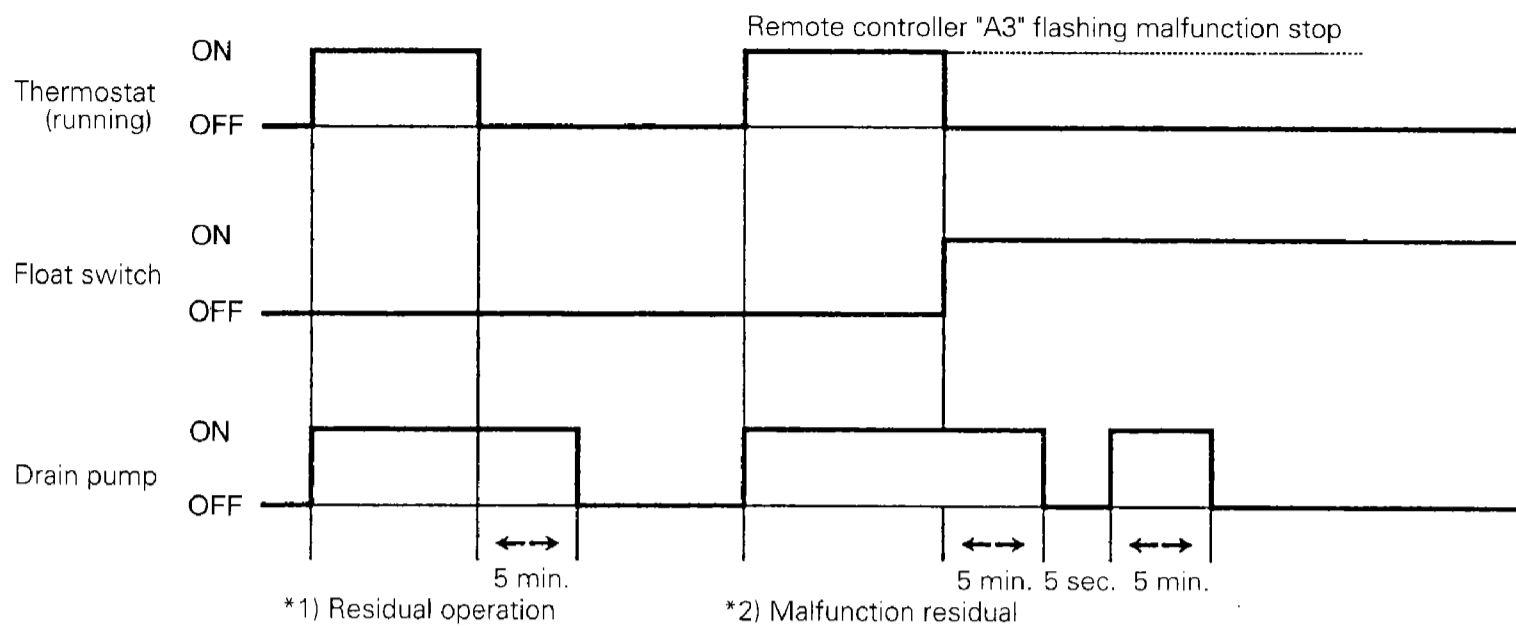

※1. The objective of residual operation is to completely drain any moisture adhering to the fin of the indoor unit heat exchanger when the thermostat goes off during cooling operation.

※2. One cycle consists of 5 minutes of operation, 5 seconds stop, and another 5 minutes of operation.

(2) When the float switch is tripped during cooling OFF by thermostat:

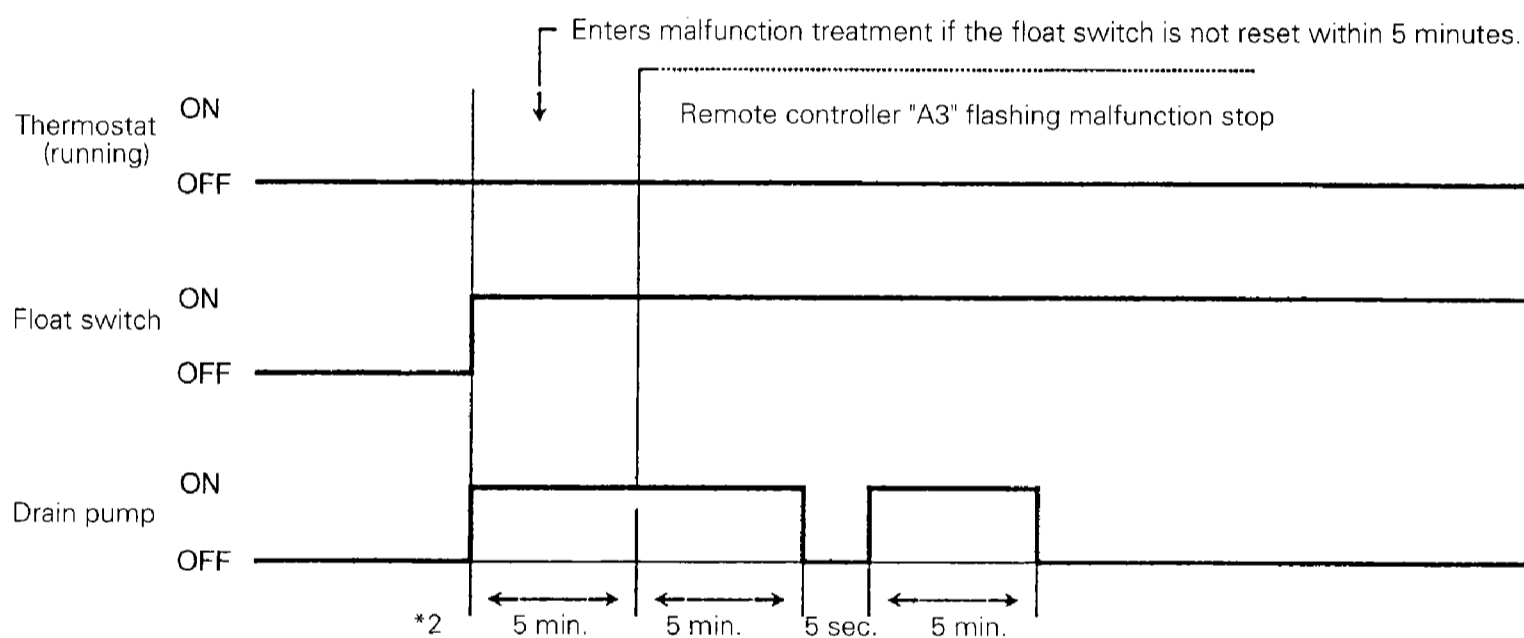

(3) When the float switch is tripped during heating operation:

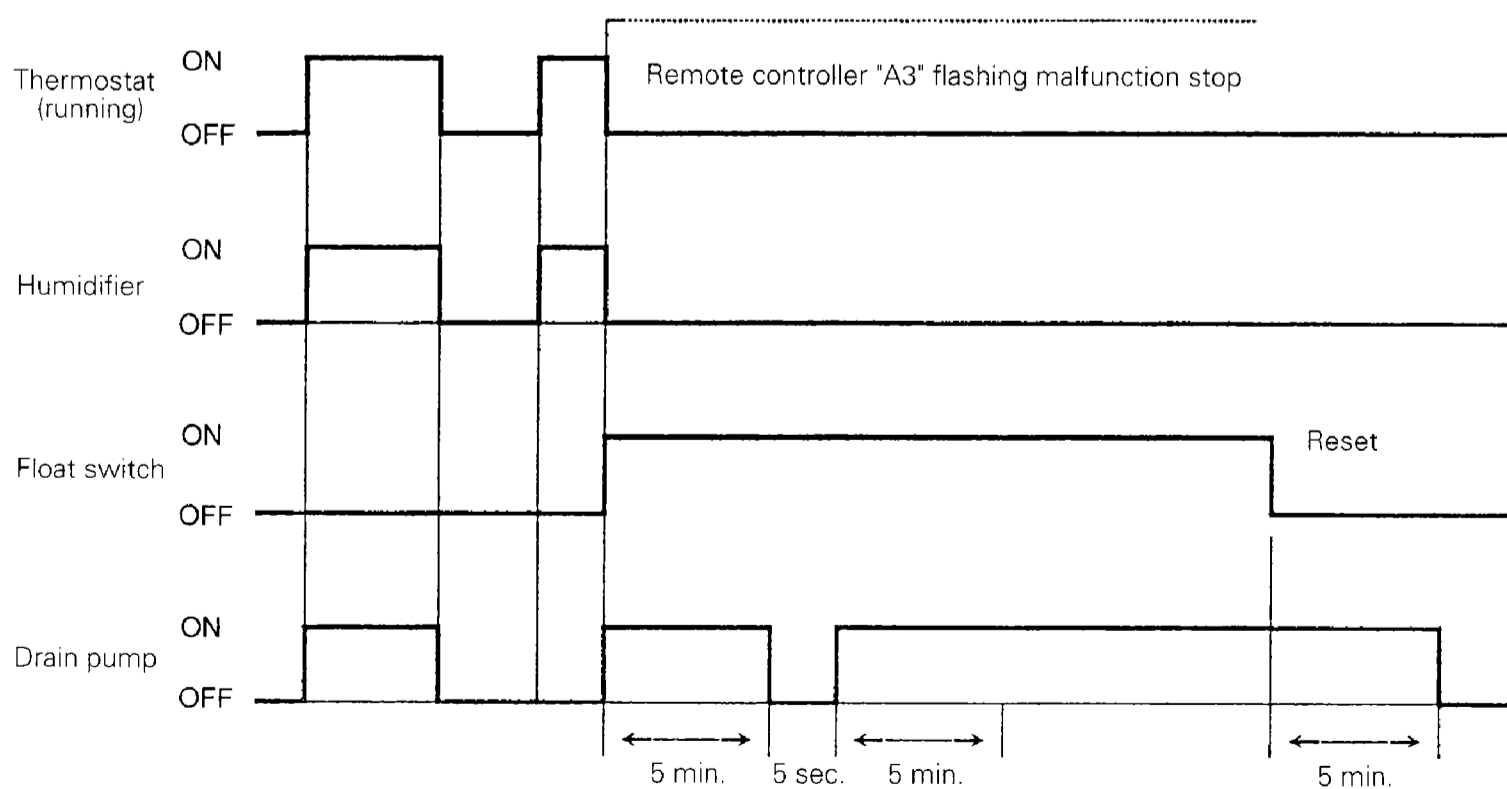

During heating operation, if the float switch is not reset even after the 5 minutes operation, 5 seconds stop, 5 minutes operation cycle ends, operation continues until the switch is reset.

(4) When the float switch is tripped and "AF" is displayed on the remote controller:

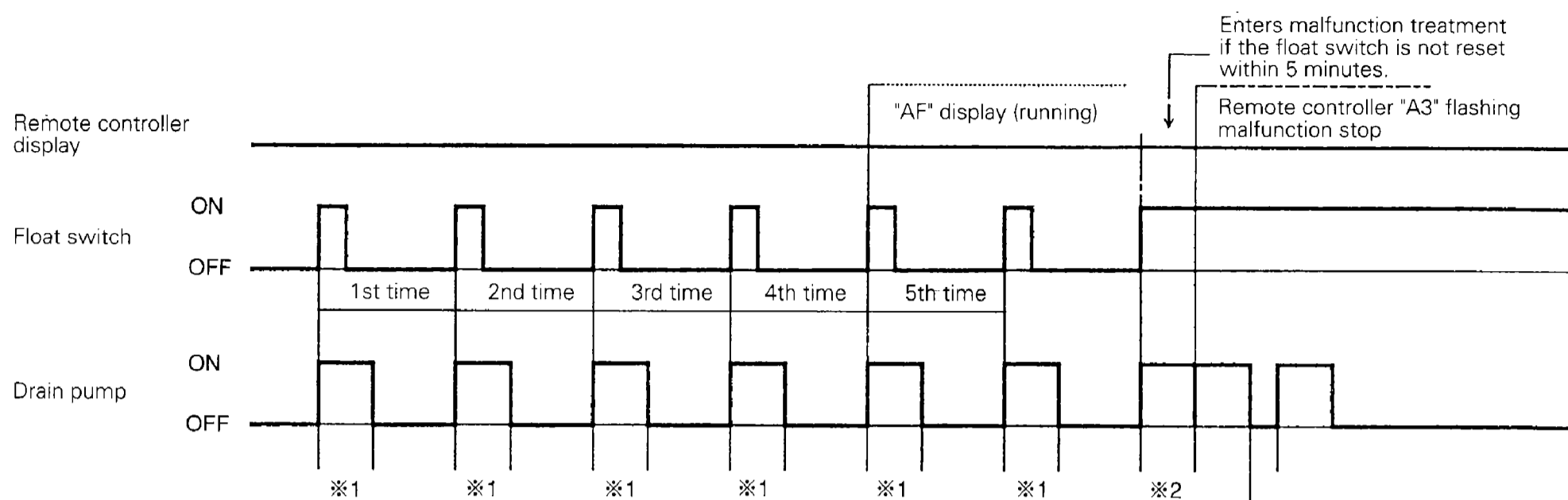

Note: If the float switch is tripped five times in succession, a drain malfunction is determined to have occurred. "AF" is then displayed as operation continues.

## 17. Oil Temperature Sensor (8 and 10 Hp only)

### (1) Prevention of wetness during heating

- Wet operation is prevented by modification of super heating (SH) by oil temperature sensor (R5T). (Low equivalent pressure =  $T_e$ )

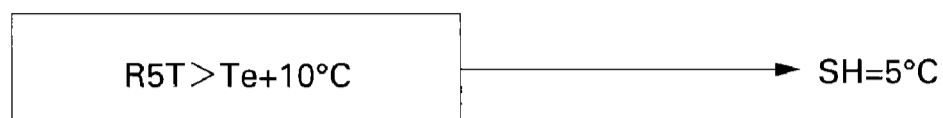
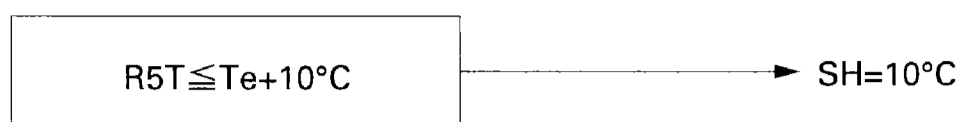

### (2) Prevention of oil dilution during defrost

- The unit controls upper limit frequency of the compressor and is designed to prevent oil from being diluted while defrosting by means of an oil temperature sensor.



- Startup subsequent to defrosting is improved by the oil temperature sensor.

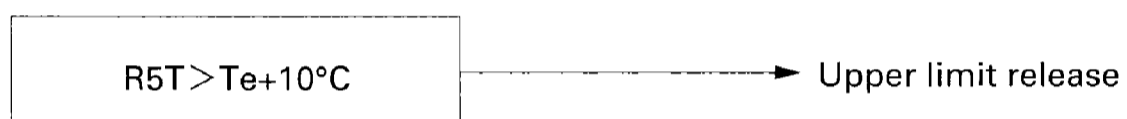

# 18. Louver Control for Preventing Ceiling Dirt

We have added a control feature that allows you to select the range of in which air direction can be adjusted in order to prevent the ceiling surrounding the air discharge outlet of ceiling mounted cassette type units from being soiled. (This feature is available on double flow, multifold and corner types.)

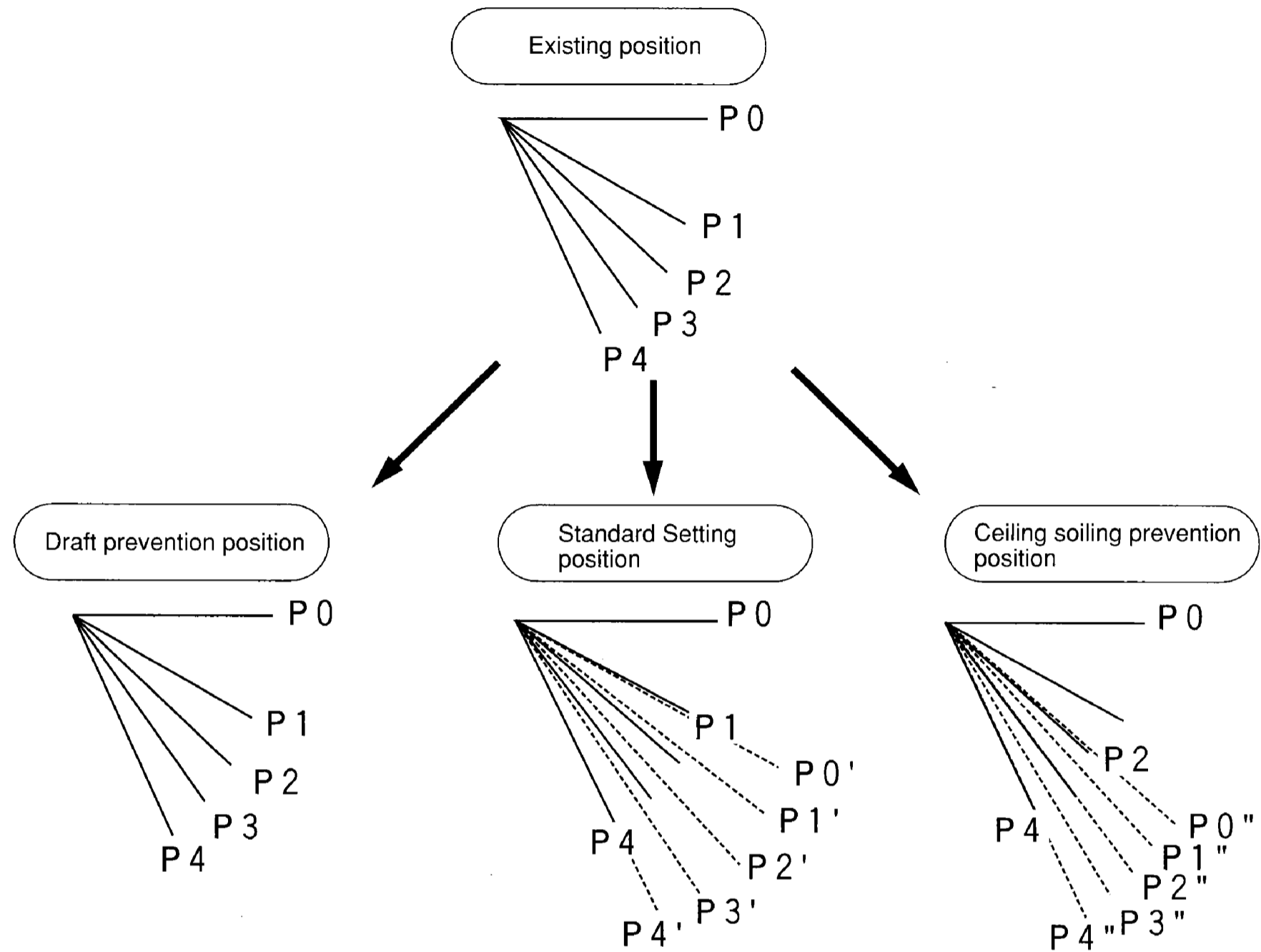

Draft prevention position	P 0	P 1	P 2	P 3	P 4	Same as existing position		
	Range of direction adjustment							
Standard position	Prohibited	P 0'	P 1'	P 2'	P 3'	P 4'	Separated into 5 positions (P 1 - 4)	
	Range of direction adjustment							
Dirt prevention position	Prohibited		P 0''	P 1''	P 2''	P 3''	P 4''	Separated into 5 positions (P 2 - 4)

The factory set position is standard position.

## 19. Thermostat Sensor in Remote Controller

Temperature is controlled by both the thermostat sensor in remote controller and air suction thermostat in the indoor unit. (This is however limited to when the field setting for the thermostat sensor in remote controller is set to "Use.")

(Cooling)

If there is a significant difference in the preset temperature and the suction temperature, fine adjustment control is carried out using a body thermostat sensor, or using the sensor in the remote controller near the position of the user when the suction temperature is near the preset temperature.

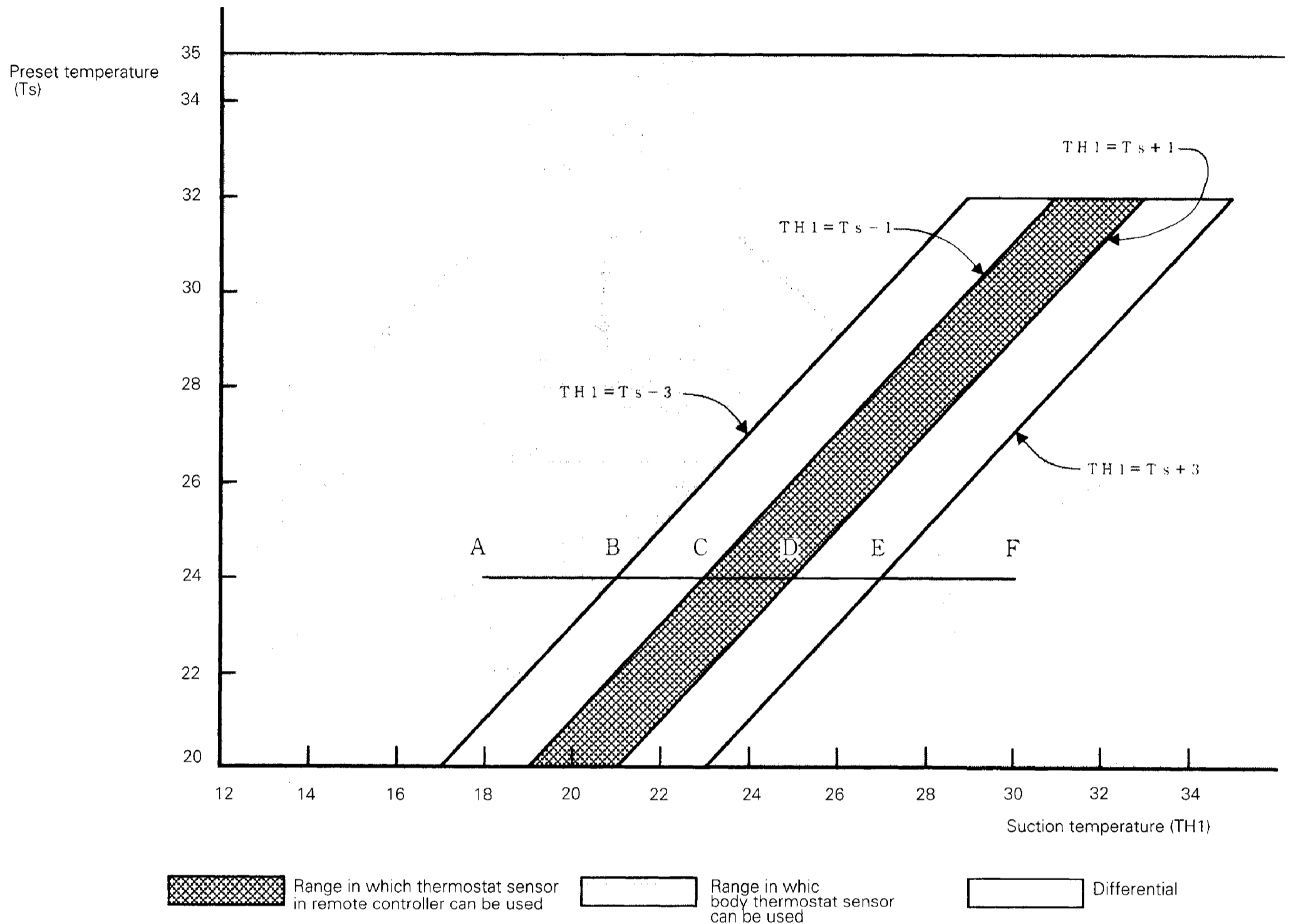

(Ex: When cooling)

Assuming the preset temperature in the figure above is 24°C, and the suction temperature has changed from 18°C to 30°C (A → F): (This example also assumes there are several other air conditioners, the VRV system is off, and that temperature changes even when the thermostat sensor is off.)

Body thermostat sensor is used for temperatures from 18°C to 23°C (A → C).

Remote controller thermostat sensor is used for temperatures from 23°C to 27°C (C → E).

Body thermostat sensor is used for temperatures from 27°C to 30°C (E → F).

And, assuming suction temperature has changed from 30°C to 18°C (F → A):

Body thermostat sensor is used for temperatures from 30°C to 25°C (F → D).

Remote controller thermostat sensor is used for temperatures from 25°C to 21°C (D → B).

Body thermostat sensor is used for temperatures from 21°C to 18°C (B → A).

(Heating)

When heating, the hot air rises to the top of the room, resulting in the temperature being lower near the floor where the occupants are. When controlling by body thermostat sensor only, the unit may therefore be turned off by the thermostat before the lower part of the room reaches the preset temperature. The temperature can be controlled so the lower part of the room where the occupants are doesn't become cold by widening the range in which thermostat sensor in remote controller can be used so that suction temperature is higher than the preset temperature.

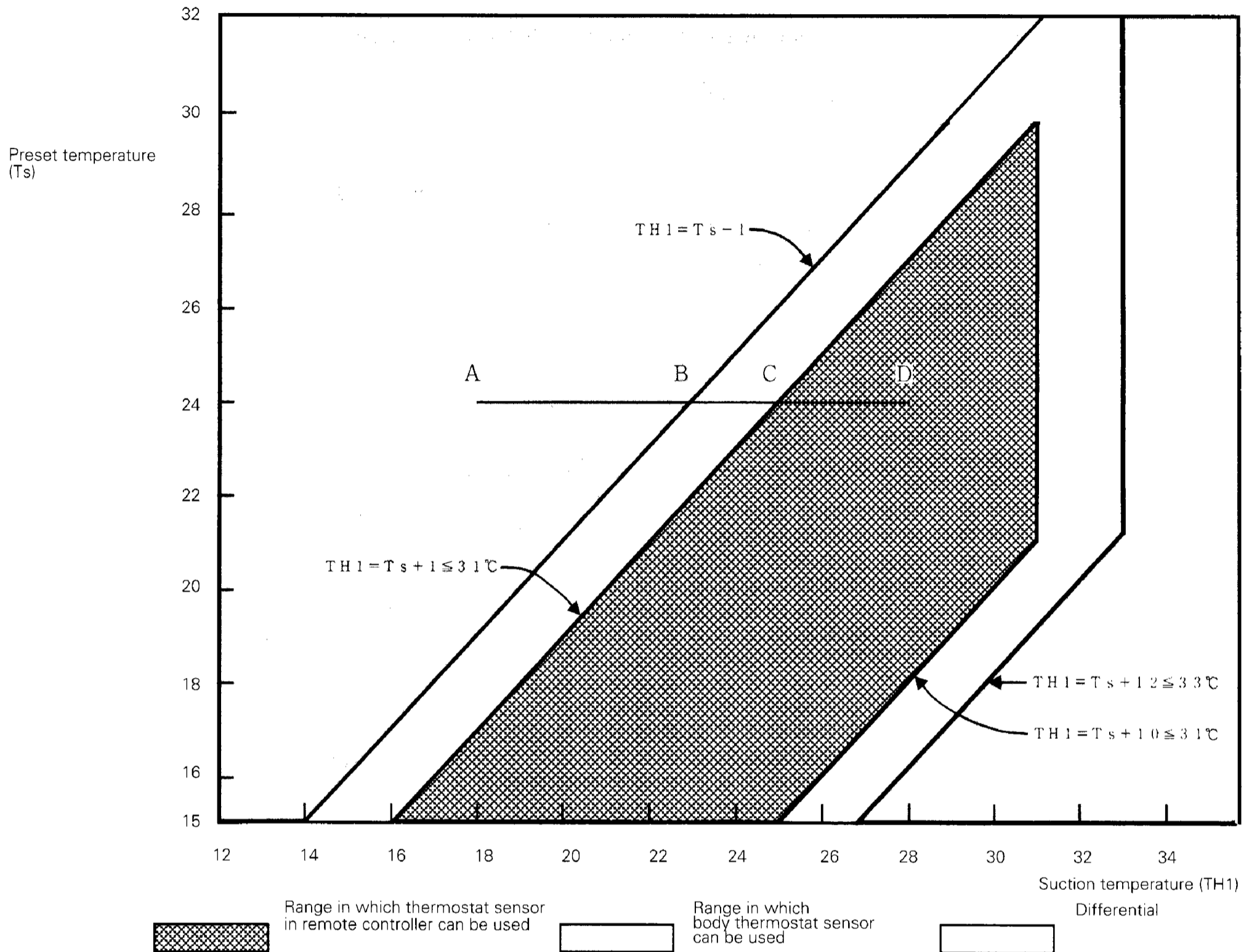

(Ex: When heating)

Assuming the preset temperature in the figure above is 24°C, and the suction temperature has changed from 18°C to 28°C (A → F): (This example also assumes there are several other air conditioners, the VRV system is off, and that temperature changes even when the thermostat sensor is off.)

Body thermostat sensor is used for temperatures from 18°C to 25°C (A → C).

Remote controller thermostat sensor is used for temperatures from 25°C to 28°C (C → E).

And, assuming suction temperature has changed from 28°C to 18°C (D → A):

Remote controller thermostat sensor is used for temperatures from 28°C to 23°C (D → B).

Body thermostat sensor is used for temperatures from 23°C to 18°C (B → A).

## 20. Freeze Prevention

Freeze prevention by off cycle (indoor unit)

When the temperature detected by liquid pipe temperature thermistor (R2T) of the indoor unit heat exchanger drops too low, the unit enters freeze prevention operation in accordance with the following conditions, and is also set in accordance with the conditions given below.

Conditions for starting freeze prevention: Temperature is  $-1^{\circ}\text{C}$  or less for total of 40 min., or temperature is  $-5^{\circ}\text{C}$  or less for total of 10 min.

Conditions for stopping freeze prevention: Temperature is  $+7^{\circ}\text{C}$  or more for 10 min. continuously

Ex: Case where temperature is  $-5^{\circ}\text{C}$  or less for total of 10 min.

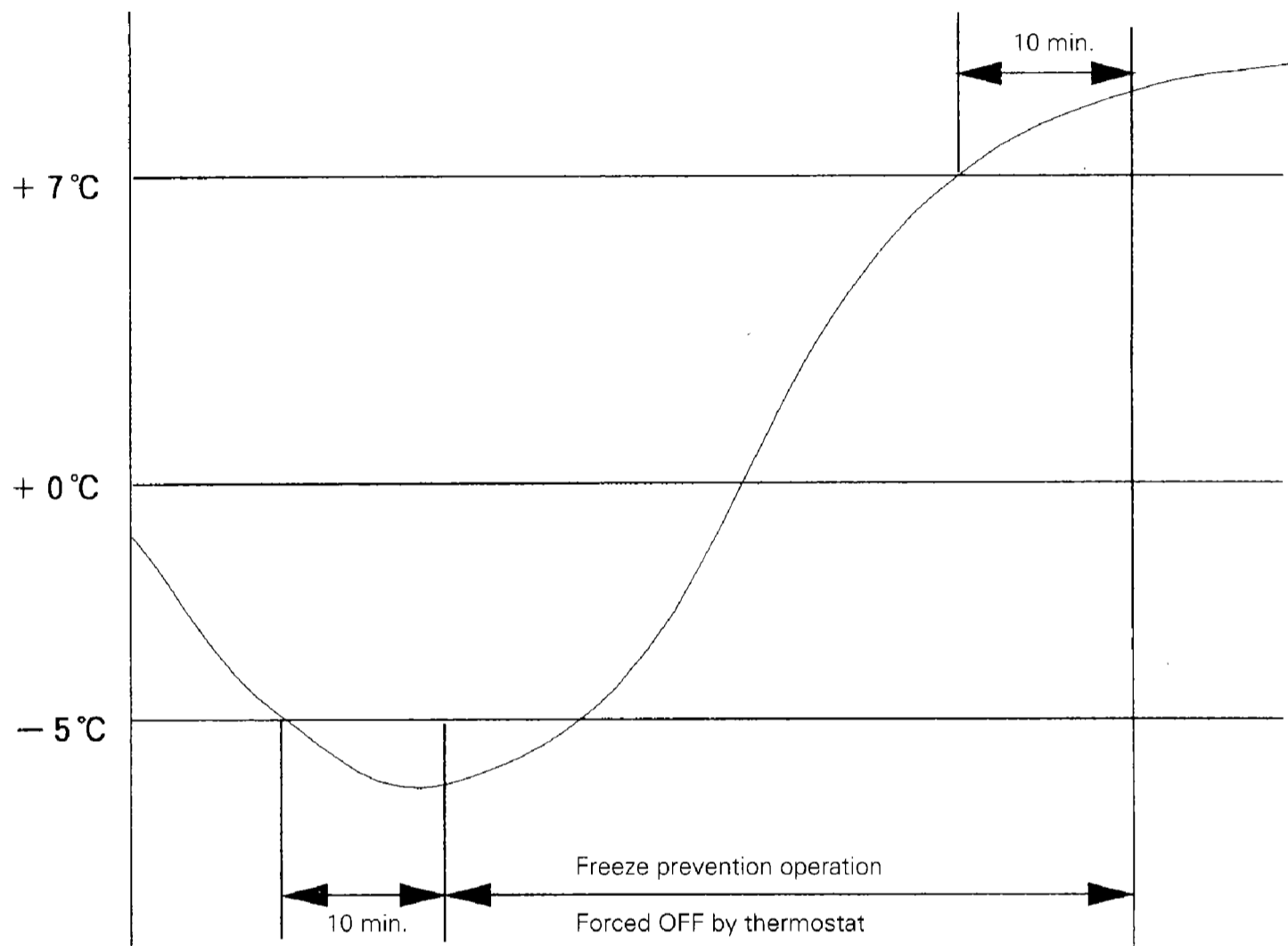



# **TEST OPERATION**

## **Inverter K Series**

# 1. When Power is Turned On

## ■ When turning power on the first time

The unit will not run for up to 12 minutes in order for master power supply and address (indoor unit address, etc.) to be set automatically.

**Outdoor unit** Warning lamp (HWL)..... On  
Test lamp (H2P) ..... Flicker  
Can be set while in operation.

**Indoor unit** "UH" malfunction code flickers when the ON/OFF button is pushed during the aforementioned operation.  
(Returns to normal when automatic setting is complete.)

## ■ When turning power on after the first time

※ Tap the RESET button on the outdoor unit PC Board. The unit can be operated after setting up for about two minutes.

If the RESET button is not pushed, the unit will not run for up to 10 minutes in order for master power supply to be set automatically.

**Outdoor unit** HWL lamp..... On  
Test lamp (H2P) ..... Flicker  
Can be set while in operation.

**Indoor unit** If the ON/OFF button is pushed during the aforementioned operation, the operation lamp lights but the unit will not run.  
(Returns to normal when automatic setting is complete.)

## ■ If outdoor, indoor or BS unit is extended, or if indoor/outdoor unit PC board is replaced:

In these cases, be sure to push and hold the RESET button for 5 seconds or more. The system will not recognize the extension if this operation is not performed. The unit will not run for up to 12 minutes in order for the addresses (indoor unit address, etc.) to be set automatically.

**Outdoor unit** Warning lamp (HWL)..... On  
Test lamp (H2P) ..... Flicker  
Can be set while in operation.

**Indoor unit** "UF" or "U4" malfunction code flickers when the ON/OFF button is pushed during the aforementioned operation.  
(Returns to normal when automatic setting is complete.)

## 2. Outdoor Unit PC Board Ass'y

RSXY8K  
10K

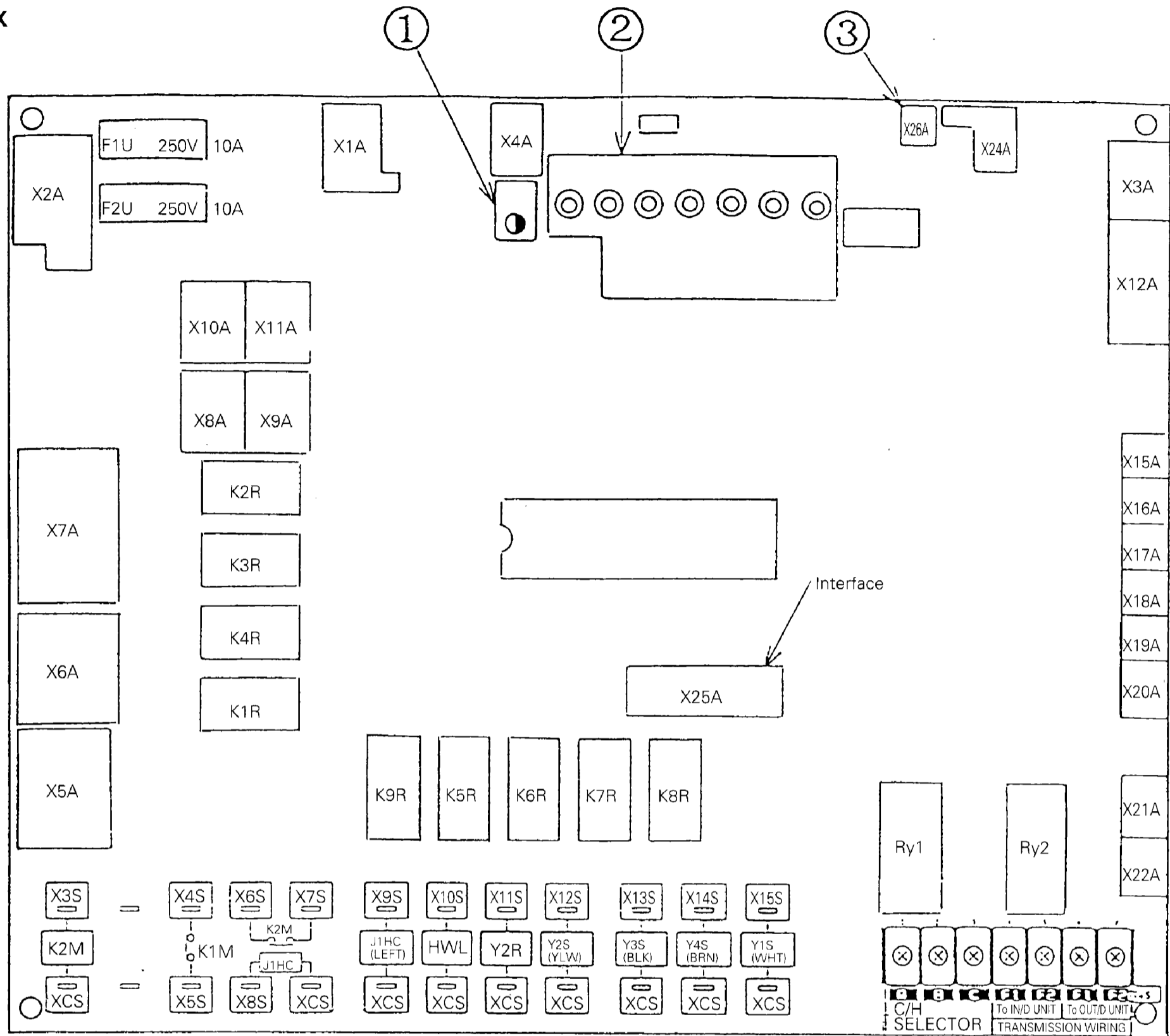

<p>① Service monitor &lt;HAP&gt; (Green)</p> <p>Function setting switch or LED</p> <p>LED display ○ : On ● : Flicker ● : Off</p> <p>② Jumper pin</p> <p>M D S</p> <p>■ ■ BLUE X26A</p>	<p>Normal ..... Flicker Malfunction ..... On or off</p> <div style="text-align: center;"> <table border="1"> <tr> <th rowspan="2">MODE</th> <th rowspan="2">TEST</th> <th colspan="3">C/H SELECT</th> <th rowspan="2">L.N.O.P.</th> <th rowspan="2">SEQ. START</th> </tr> <tr> <th>IND</th> <th>MASTER</th> <th>SLAVE</th> </tr> <tr> <td>○ H1P</td> <td>○ H2P</td> <td>○ H3P</td> <td>○ H4P</td> <td>○ H5P</td> <td>○ H6P</td> <td>○ H7P</td> </tr> </table>   <table border="1"> <tr> <td>○ MODE</td> <td>○ SET</td> <td>○ RETURN</td> <td>○ WIRING CHECK</td> <td>○ RESET</td> </tr> <tr> <td>BS1</td> <td>BS2</td> <td>BS3</td> <td>BS4</td> <td>BS5</td> </tr> </table> <p>Pushbutton switch</p> <p>② Mode button ..... Mode change</p> <p>Setting mode 1 (H1P off) → Push 1 time. → Monitor mode (H1P flickers) → Push 1 time. → Setting mode 2 (H1P on) → Push 1 time.</p> <p>Setting mode 1 (H1P off) → Push and hold for 5 sec. → Setting mode 2 (H1P on) → Push 1 time.</p> <ul style="list-style-type: none"> <li>• Set return button ..... Changes or enters address or data.</li> <li>• Wiring check button ... Push and hold for 5 sec. to start wiring check.</li> <li>• Reset button ..... Push and hold for 5 sec. if the indoor unit's PC board has been replaced, or there has been a change in the combination of indoor and outdoor units, such as indoor unit extension, etc.</li> </ul> <p>③ Forced defrost operation by short circuit.</p> </div>	MODE	TEST	C/H SELECT			L.N.O.P.	SEQ. START	IND	MASTER	SLAVE	○ H1P	○ H2P	○ H3P	○ H4P	○ H5P	○ H6P	○ H7P	○ MODE	○ SET	○ RETURN	○ WIRING CHECK	○ RESET	BS1	BS2	BS3	BS4	BS5
MODE	TEST			C/H SELECT					L.N.O.P.	SEQ. START																		
		IND	MASTER	SLAVE																								
○ H1P	○ H2P	○ H3P	○ H4P	○ H5P	○ H6P	○ H7P																						
○ MODE	○ SET	○ RETURN	○ WIRING CHECK	○ RESET																								
BS1	BS2	BS3	BS4	BS5																								

### 3. Setting Modes

The three setting modes are as follows:

- **Setting mode 1** .....Mode for selecting cool/heat setting method, and whether or not to use low noise operation and sequential start.  
(H1P off)
- **Setting mode 2** .....Mode for changing operating status and setting addresses; used primarily for service.  
(H1P on)
- **Monitor mode** .....Mode for checking setting made in the setting modes, number of connected units, etc.  
(H1P flickers)

The flow of the setting modes is as follows. (See the following pages for details.)

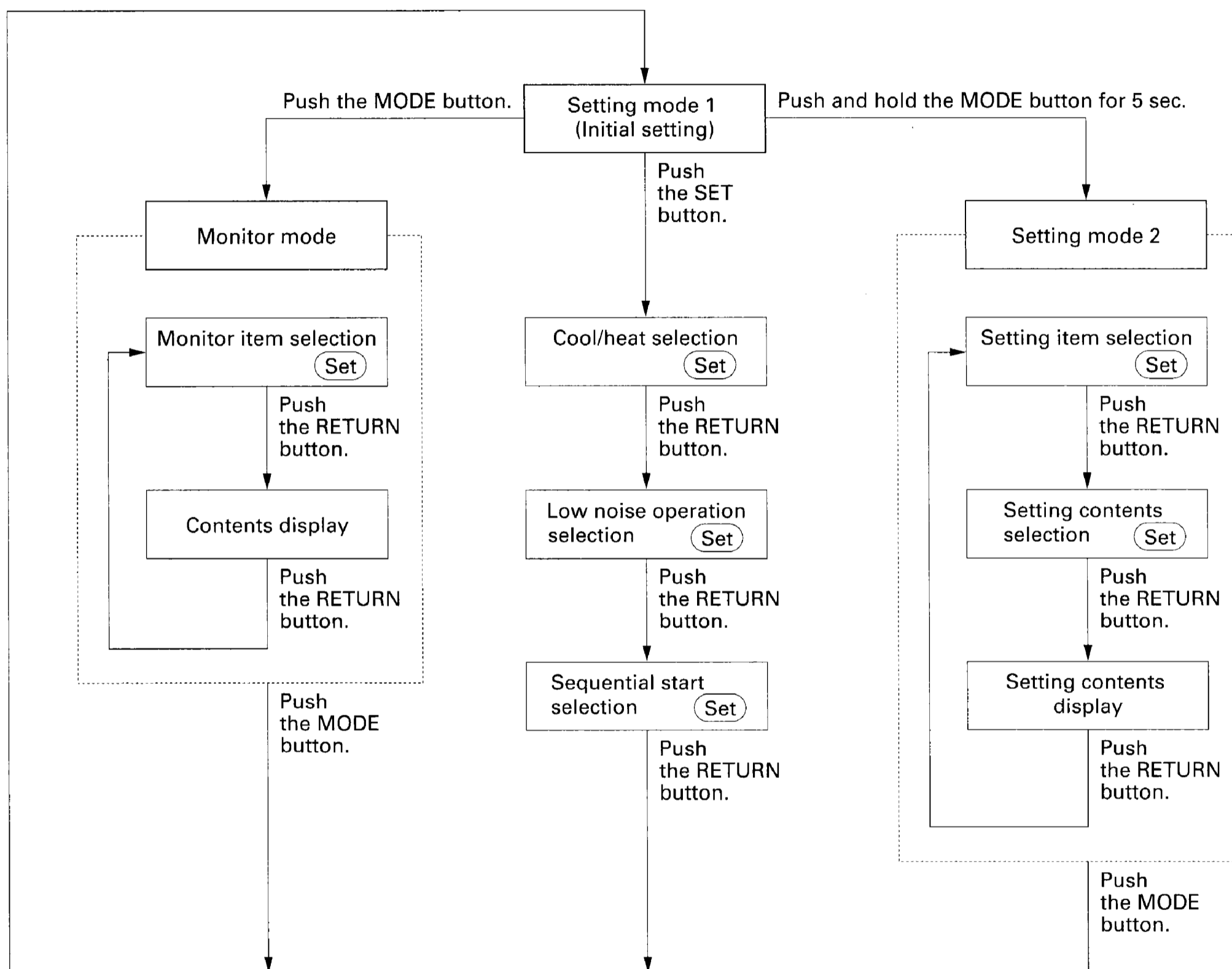

- You can make your selections with the SET button. (Set)

If you become unsure of how to proceed, push the MODE button and return to setting mode 1.

- ☆ You don't have to perform power supply reset after changing settings in setting mode 1 (including [SS1] cool/heat selection switch on the outdoor unit PC board) and setting mode 2.

# (1) Setting Mode 1

Cool/heat selection setting (SS1) If carried out from the indoor unit remote controller: If carried out from the cool/heat selector:

IND UNIT	OUT/D UNIT	C/H SELECT
■		SS1

(Factory set)

IND UNIT	OUT/D UNIT	H/C SELECT
	■	SS1

MODE	TEST	C/H SELECT			L.N.O.P.	SEQ. START
		IND	MASTER	SLAVE		
●	●	○	●	●	●	○
H1P	H2P	H3P	H4P	H5P	H6P	H7P



The factory settings are:

Individual (C/H SELECT), OFF (L.N.O.P.), ON (SEQ. START)

You can change the cool/heat selection permission, low noise and sequential start settings by pushing the SET switch.

To skip settings you don't want to change, push the RETURN switch and go to the next setting.

Change cool/heat selection to MASTER.

An optional adaptor for outside control of outdoor units is required if you have set cool/heat selection to MASTER or SLAVE.

MODE	TEST	C/H SELECT			L.N.O.P.	SEQ. START
		IND	MASTER	SLAVE		
●	●	○	●	●	○	○
H1P	H2P	H3P	H4P	H5P	H6P	H7P

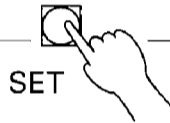

MODE	TEST	C/H SELECT			L.N.O.P.	SEQ. START
		IND	MASTER	SLAVE		
●	●	●	○	●	○	○
H1P	H2P	H3P	H4P	H5P	H6P	H7P



MODE	TEST	C/H SELECT			L.N.O.P.	SEQ. START
		IND	MASTER	SLAVE		
●	●	●	○	○	○	○
H1P	H2P	H3P	H4P	H5P	H6P	H7P

Change low noise operation to "ON".

External control adaptor for outdoor unit is required if low noise operation is set to "ON".

MODE	TEST	C/H SELECT			L.N.O.P.	SEQ. START
		IND	MASTER	SLAVE		
●	●	●	○	○	○	○
H1P	H2P	H3P	H4P	H5P	H6P	H7P

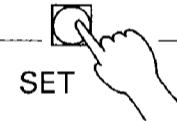
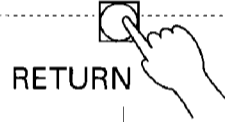

MODE	TEST	C/H SELECT			L.N.O.P.	SEQ. START
		IND	MASTER	SLAVE		
●	●	●	○	○	○	●
H1P	H2P	H3P	H4P	H5P	H6P	H7P

Change sequential start to "OFF".

MODE	TEST	C/H SELECT			L.N.O.P.	SEQ. START
		IND	MASTER	SLAVE		
●	●	●	○	○	○	○
H1P	H2P	H3P	H4P	H5P	H6P	H7P



MODE	TEST	C/H SELECT			L.N.O.P.	SEQ. START
		IND	MASTER	SLAVE		
●	●	●	○	○	○	○
H1P	H2P	H3P	H4P	H5P	H6P	H7P

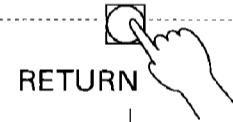

Setting complete

GROUP MASTER (cool/heat selection), ON (low noise), OFF (sequential start)

MODE	TEST	C/H SELECT			L.N.O.P.	SEQ. START
		IND	MASTER	SLAVE		
●	●	●	○	○	○	○
H1P	H2P	H3P	H4P	H5P	H6P	H7P

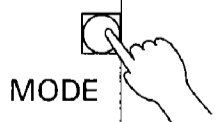
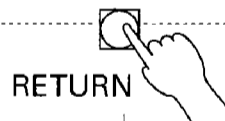

Monitor mode

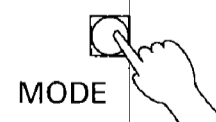

Push and hold for 5 sec.

Setting mode 2

NOTE: 1. RSXY5K is completed by low noise setting.

2. External control adaptor for outdoor unit is required if cool/heat selection set to MASTER or SLAVE, or if low noise operation is set to ON. For further information, see page 47.

## (2) Setting Mode 2

To enter setting mode 2 from setting mode 1 (normal), you must push and hold the MODE button (BS1) for 5 seconds. (Setting mode 2 cannot be entered while still making settings in setting mode 1.)

### Setting procedure

① Push the SET button and match with the setting item (LED display).  
(All 10 settings)



② Push the RETURN button (BS3) and the present settings flicker (LED display).



③ Push the SET button (BS2) and match with each setting (LED flicker display).



④ Push the RETURN button (BS3) and enter the settings.



⑤ Push the RETURN button (BS3) and return to the initial status.

Note: ● If you become unsure of how to proceed, push the MODE button (BS1) and return to setting mode 1.

● The initial status of setting mode 2 is the status of setting item No. 1 in mode 2.

☆1 ...Cannot be set with RSXY5K.

### Settings

	Setting item	Description	LED display								LED display																												
			H1P	H2P	H3P	H4P	H5P	H6P	H7P		H1P	H2P	H3P	H4P	H5P	H6P	H7P																						
1	EMG ☆1	Emergency operation when malfunction occurs	○	●	●	●	●	●	●	Emergency operation	○	●	●	●	○	●	(Runs only by standard compressor)	○	●	●	●	●	○	Normal operation	○	●	●	●	●	○									
2	Cool/heat group address	Address for cool/heat group operation	○	●	●	●	●	○	○	Address	0	○	●	●	●	●	●	Binary number (6 digits)	1	○	●	●	●	●	○	2	○	●	●	●	○	●	31	○	●	○	○	○	○
3	Low noise / demand address	Address for low noise / demand group operation	○	●	●	●	○	○	●	Address	0	○	●	●	●	●	●	Binary number (6 digits)	1	○	●	●	●	○	●	2	○	●	●	○	●	●	31	○	●	○	○	○	○
4	Forced fan switch	Fan of stopped indoor unit turns	○	●	●	○	○	○	○	Forced fan operation (H tap)	○	●	●	●	○	●	Normal operation	○	●	●	●	○	○	○	●	●	○	○	○										
5	Indoor unit forced operation	Allows operation of indoor unit from outdoor unit	○	●	●	○	○	○	●	Indoor unit forced operation	○	●	●	●	○	●	Normal operation	○	●	●	●	○	○																
6	Frequency fix	Fixes the frequency of the inverter compressor 5HP...68Hz 8.10HP...86Hz+ON	○	●	●	○	○	○	○	Frequency fix	○	●	●	○	○	●	Normal operation	○	●	●	○	○	○																
7	Te setting	Low pressure setting for cooling	○	●	○	○	○	○	○	High	○	●	●	○	○	●	Normal (factory set)	○	●	●	○	○	○	Low	○	●	●	○	○	○									
8	Tc setting	High pressure setting for heating	○	●	○	○	○	○	○																														
9	Defrost setting	Temperature setting for defrost	○	●	○	○	○	○	○	Quick defrost	○	●	●	○	○	○	Normal (factory set)	○	●	●	○	○	○	Slow defrost	○	●	●	○	○	○									
10	Not used	Airnet address	○	●	○	○	○	○	○	Address	0	○	●	●	○	○	○	Binary number (6 digits)	1	○	●	●	○	○	○	2	○	●	○	○	○	○	63	○	○	○	○	○	○

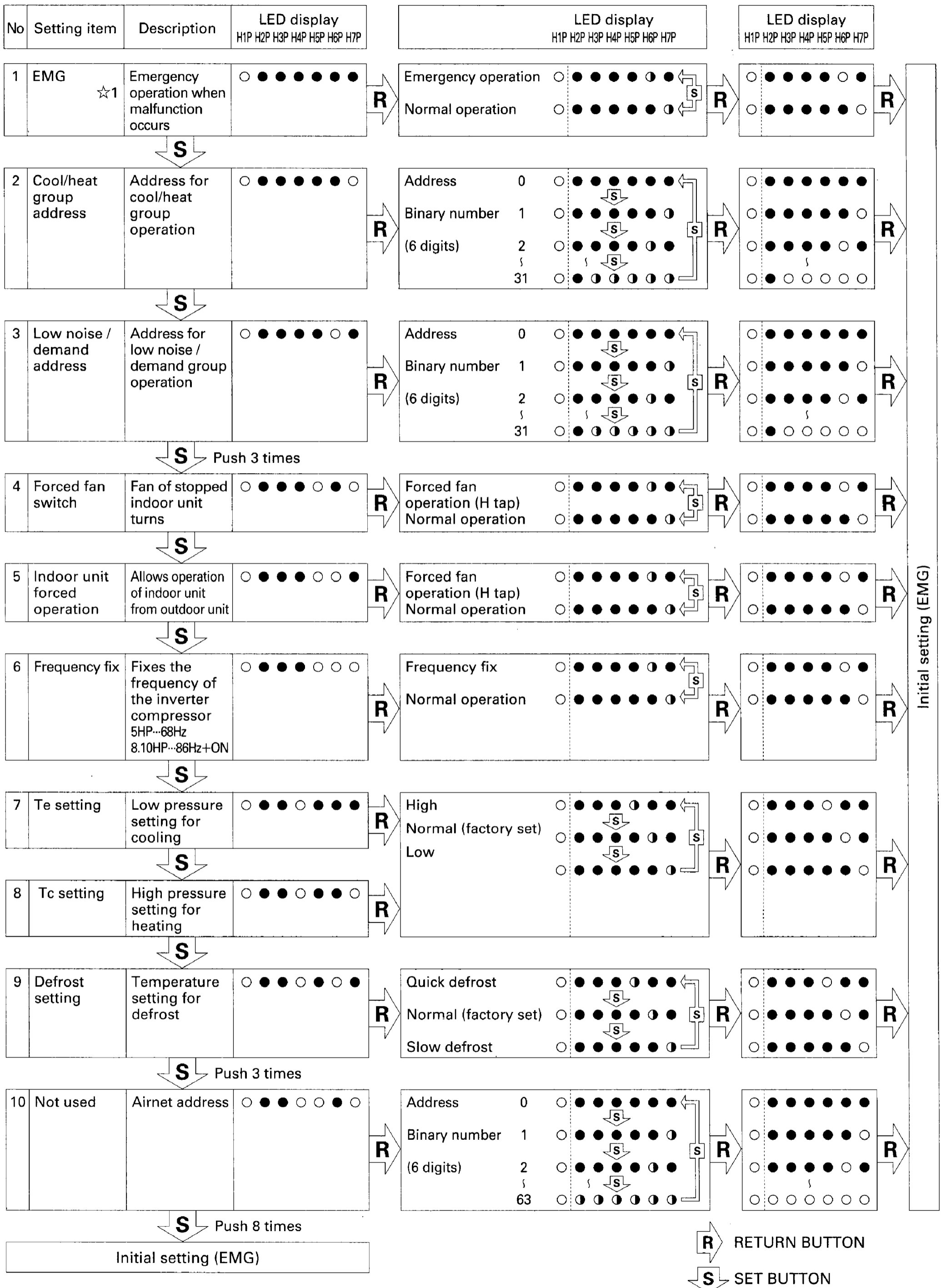

### (3) Monitor Mode

MODE	TEST	C/H SELECT			L.N.O.P.	SEQ. START
		IND	MASTER	SLAVE		
<input checked="" type="radio"/> H1P	<input checked="" type="radio"/> H2P	<input type="radio"/> H3P	<input checked="" type="radio"/> H4P	<input checked="" type="radio"/> H5P	<input checked="" type="radio"/> H6P	<input type="radio"/> H7P

To enter the monitor mode, push the MODE button when in setting mode 1.

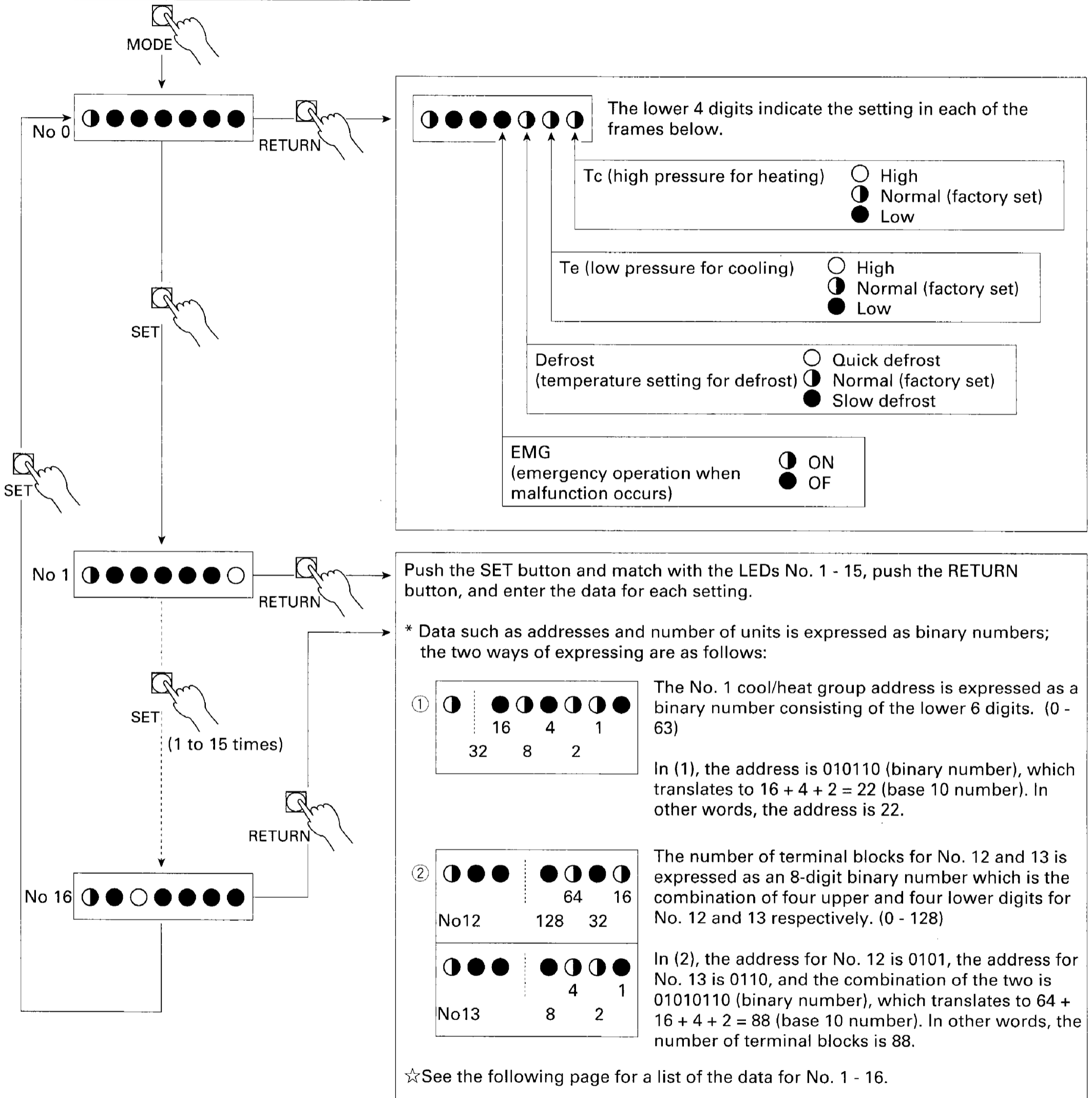

☆After making sure the data is correct, push the RETURN button and return to No. 0, or push the MODE button and return to setting mode 1.



• Monitor Mode Data

Mode No.	LED	Data	Display method	Size (binary number)
No 1	● ● ● ● ● ● ○	Cool/heat group address	0 ~ 31	Lower 6 digits
No 2	● ● ● ● ● ○ ●	Low noise / demand address	0 ~ 31	Lower 6 digits
No 3	● ● ● ● ● ○ ○	Not used		
No 4	● ● ● ● ○ ● ●	Not used	0 ~ 63	Lower 6 digits
No 5	● ● ● ● ○ ● ○	Number of connected units	0 ~ 63 units	Lower 6 digits
No 6	● ● ● ● ○ ○ ●	Number of connected BS units	0 ~ 63 units	Lower 6 digits
No 7	● ● ● ● ○ ○ ○	Number of connected zone units (excluding outdoor and BS units)	0 ~ 63 units	Lower 6 digits
No 8	● ● ● ○ ● ● ●	Number of outdoor units	0 ~ 63 units	Lower 6 digits
No 9	● ● ● ○ ● ● ○	Number of BS units	0 ~ 128 units	Lower 4 digits, upper
No 10	● ● ● ○ ● ○ ●	Number of BS units	0 ~ 128 units	Lower 4 digits, lower
No 11	● ● ● ○ ● ○ ○	Number of zone units (excluding outdoor and BS units)	0 ~ 63 units	Lower 6 digits
No 12	● ● ● ○ ○ ● ●	Number of terminal blocks	0 ~ 128 units	Lower 4 digits, upper
No 13	● ● ● ○ ○ ● ○	Number of terminal blocks	0 ~ 128 units	Lower 4 digits, lower
No 14	● ● ● ○ ○ ○ ●	Not used		
No 15	● ● ● ○ ○ ○ ○	Not used		
No 16	● ● ○ ● ● ● ●	Not used		

## 4. Sequential Start

Separates the start timing for standard compressors by three seconds each in order to prevent over-current when several compressors are to be started simultaneously.

Sequential start is possible for up to three units wired as a group to a single power supply. You should however connect an outdoor unit of small capacity as the third unit in the sequence.

### Method of sequential start

#### ① Power supply wiring

Must be wired as a group to the power supply.

#### ② Wiring

Connect transmission wiring to terminals F1 and F2 (outdoor - outdoor) on the outdoor unit PC board (EC1). Switch to the monitoring mode and see if sequential start has been selected. If not, switch to setting mode 1 and select sequential start.

(Sequential start is factory set to "ON.") For transmission wiring, use 0.75 - 1.25 mm<sup>2</sup> sheathed vinyl cord or double-core cable.

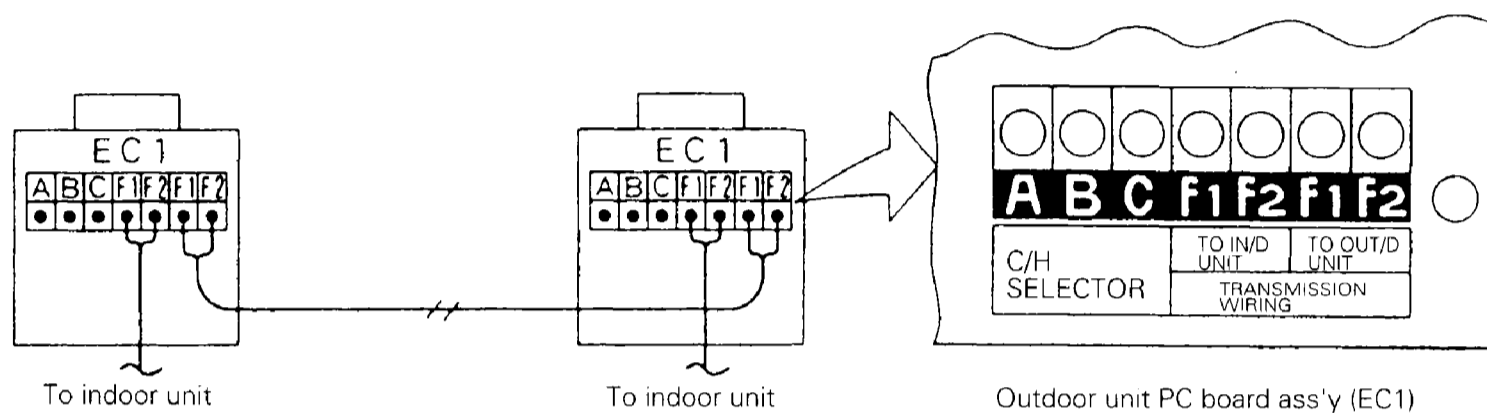

## 5. External Control Adaptor for Outdoor Unit

### Purpose / application

External control adaptor for outdoor unit is required in order for the VRV System Inverter K Series to carry out the types of control given below.

1. Group switching of cool/heat mode for more than one outdoor unit system. The adaptor is required for cool/heat selection by indoor unit remote controller, by cool/heat selector, or by cool/heat central remote controller.
2. Low noise control
3. Demand control

### Installation position

The adaptor can be installed inside any indoor unit or BS unit connected to a D III-NET.

### Part names and functions

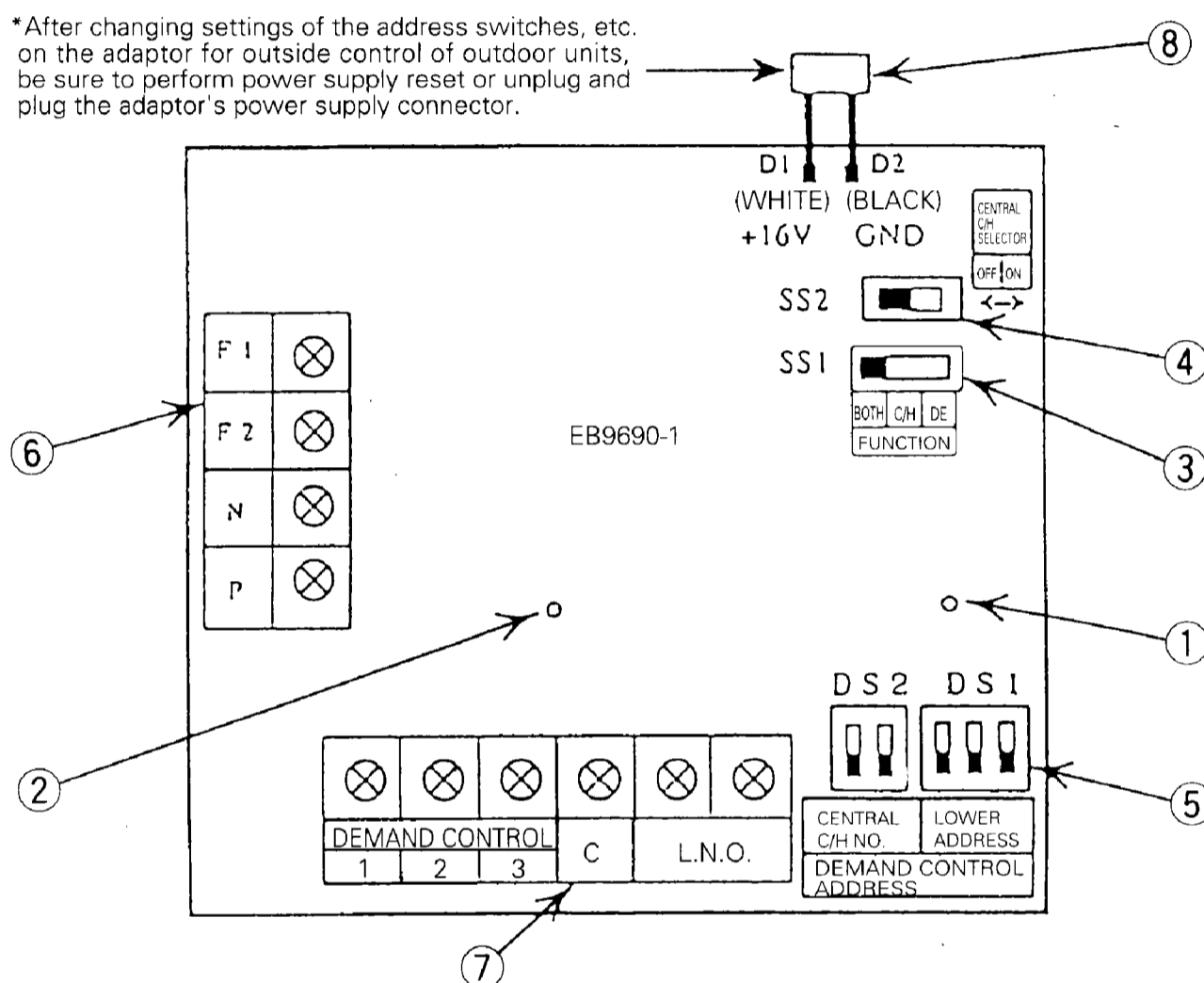

①	SERVICE MONITOR [HAP] (Green)	Normal: Flicker Malfunction: On or off	LED display ○ : On ◐ : Flicker ● : Off
②	SERVICE MONITOR [H01P] (Green)	When using cool/heat central remote controller: Normal: On Malfunction: Off (If not using cool/heat central remote controller, LED remains off.)	
③	Function switch [SS1] (Factory set: BOTH)	Sets whether the address setting switch will set cool/heat address, demand / low noise address, or both. <div style="display: flex; justify-content: space-around; align-items: center;"> <div style="text-align: center;"> <input type="checkbox"/> Left (BOTH)         </div> <div style="text-align: center;"> <input type="checkbox"/> Middle (C / H)         </div> <div style="text-align: center;"> <input type="checkbox"/> Right (DE·LOW NOISE)         </div> </div>	
④	Cool/heat central remote controller selection switch [SS2] (Factory set: No)	Sets whether cool/heat central remote controller is connected or not. <div style="display: flex; justify-content: space-around; align-items: center;"> <div style="text-align: center;"> <input type="checkbox"/> Left (Not connected)         </div> <div style="text-align: center;"> <input type="checkbox"/> Right (Connected)         </div> </div>	
⑤	Address setting switch [DS2 / DS1] (Factory set: 0)	Sets cool/heat address or demand address. <div style="display: flex; justify-content: space-around; align-items: center;"> <div style="text-align: center;"> <input type="checkbox"/> Upper 2 bits (ON) (1)         </div> <div style="text-align: center;"> <input type="checkbox"/> Lower 3 bits (OFF) (0)         </div> </div> (The black part represents the switch.)	
⑥	Terminal block for transmission (F1 / F2) (N / P)	F1 / F2 : Wiring connection with terminals F1 and F2 of outdoor unit, etc. N / P : Wiring connection with terminals N and P of cool/heat central remote controller.	
⑦	Demand / low noise input terminal block (X1M)	Connects control input from remote source (host computer monitor panel, demand controller, timer, etc.).	
⑧	Power supply connector (D1 / D2)	Connects "power supply connector for adaptor for outside control of outdoor units" of indoor unit or BS unit, etc.	

## System examples

### Group selection of cool/heat mode by indoor unit remote controller

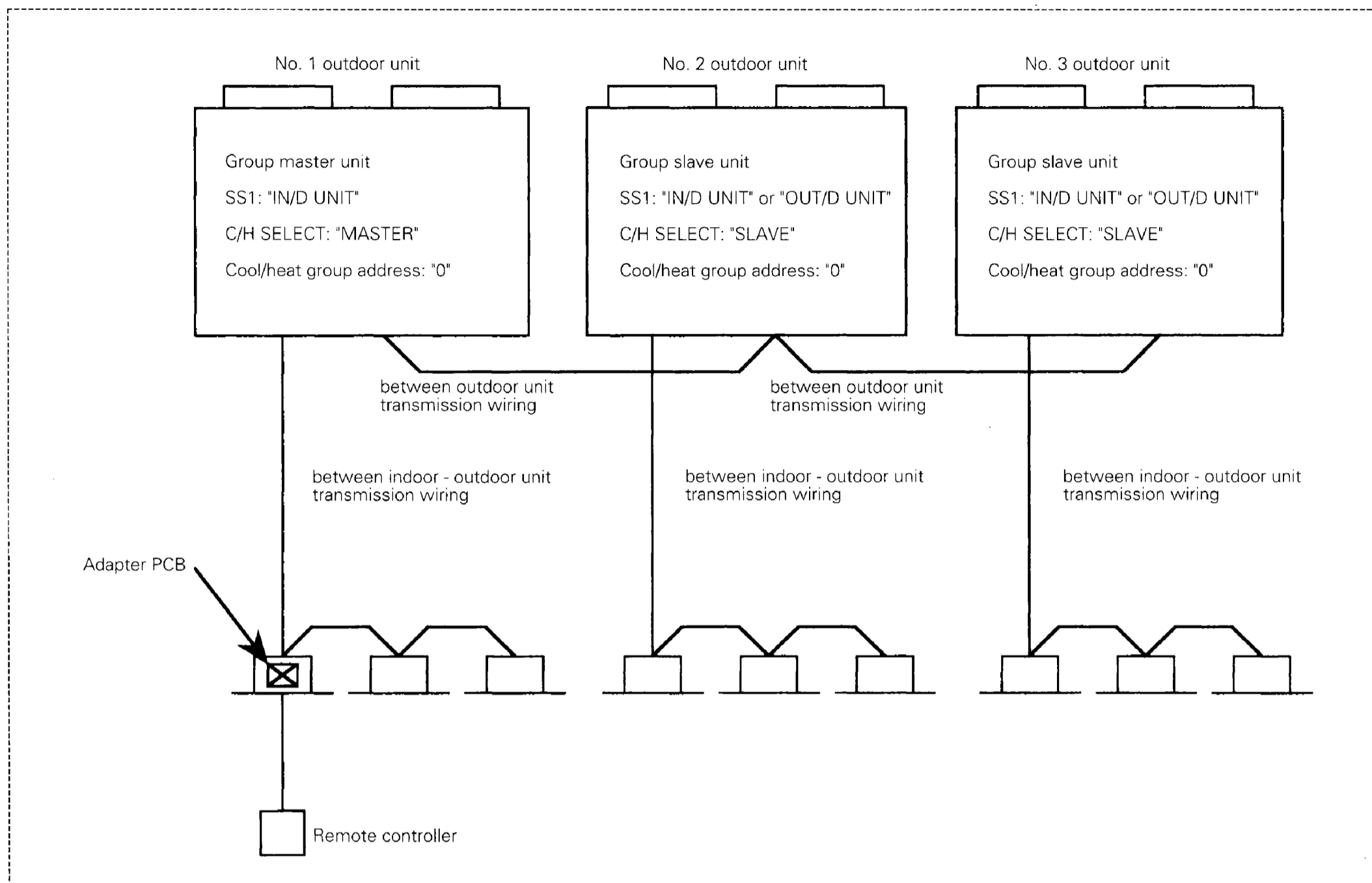

#### Switch settings on the adaptor PCB

- SS1

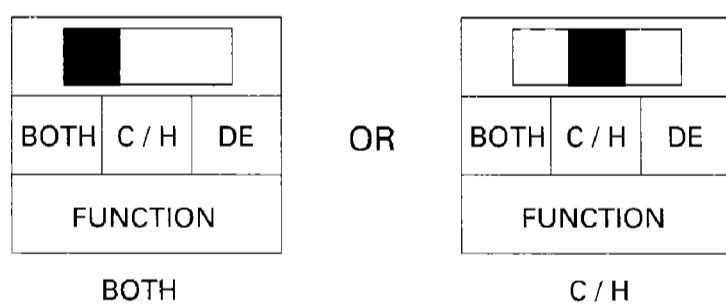

- SS2

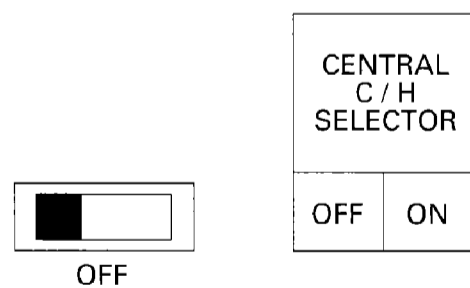

- DS1 / DS2

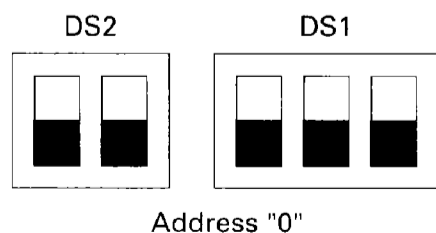

#### Outdoor unit PCB settings

- Group master unit**
  - SS1: "IN/D UNIT"
  - Setting mode 1
  - C / H SELECT : "MASTER"
  - Setting mode 2
  - Cool/heat group address: "0"
  - Combines DS1 and DS2 of PC board adaptor.
- Group slave unit**
  - SS1: "IN/D UNIT" or "OUT/D UNIT"
  - Setting mode 1
  - C / H SELECT : "SLAVE"
  - Setting mode 2
  - Cool/heat group address: "0"
  - Combines DS1 and DS2 of adaptor PCB.

## 6. Cool/Heat Mode Selection

The VRV System Inverter K Series offers the following four cool/heat mode selections.

- (1) Setting of cool/heat by individual outdoor unit system by indoor unit remote controller
- (2) Setting of cool/heat by individual outdoor unit system by cool/heat selector
- (3) Setting of cool/heat by outdoor unit system group in accordance with group master outdoor unit by indoor unit remote controller
- (4) Setting of cool/heat by outdoor unit system group in accordance with group master outdoor unit by cool/heat selector

Each of these setting methods is explained in detail below.

(For (3) and (4) be sure to perform power supply reset after changing settings.)

### (1) Setting of cool/heat by individual outdoor unit system by indoor unit remote controller

- Doesn't matter whether or not there is outdoor - outdoor unit wiring.
- Set SS1 of the outdoor unit PCB to "IN / D UNIT" (factory set).
- In setting mode 1, set cool/heat selection to "IND" (factory set).

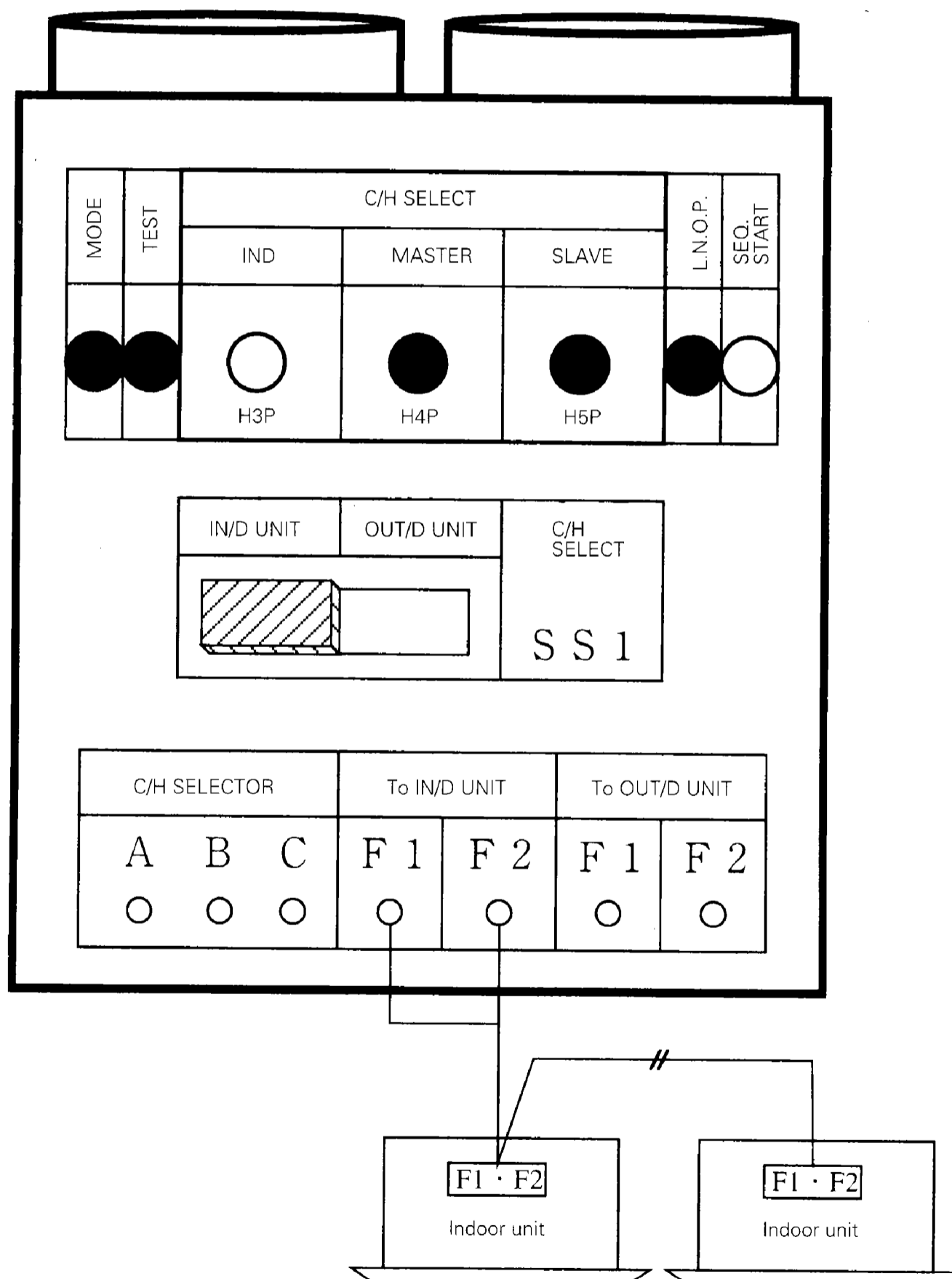

**(2) Setting of cool/heat by individual outdoor unit system by cool/heat selector**

- Doesn't matter whether or not there is outdoor - outdoor unit wiring.
- Set SS1 of the outdoor unit PC board to "OUT / D UNIT."
- In setting mode 1, set cool/heat selection to "IND" (factory set).

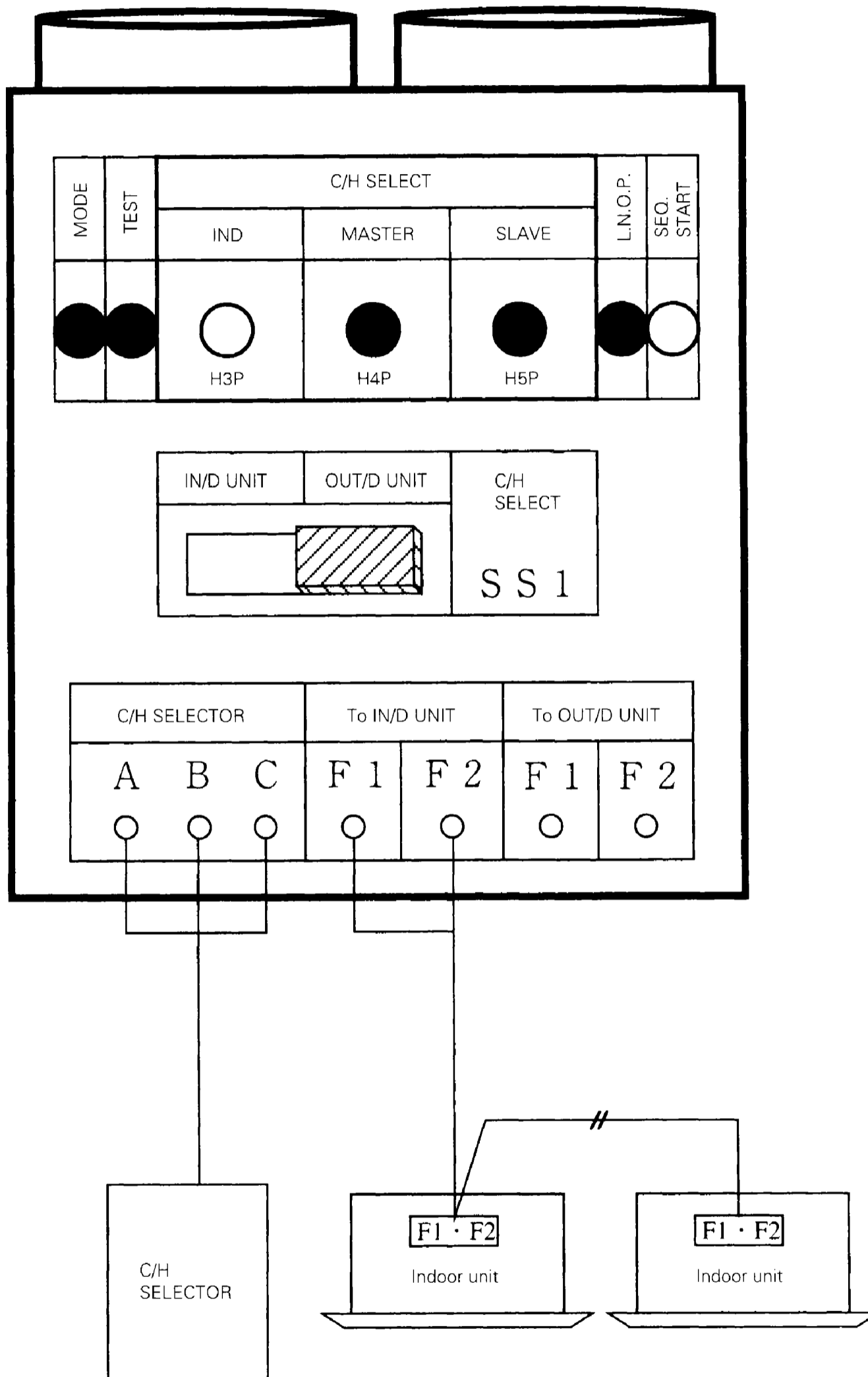

**(3) Setting of cool/heat by outdoor unit system group in accordance with group master outdoor unit by indoor unit remote controller**

- Install the External control adaptor for outdoor unit on either the outdoor - outdoor, indoor - outdoor, or indoor - indoor transmission line.
- Set SS1 of the outdoor unit PCB to "IN / D UNIT" (factory set).
- In setting mode 1, set the outdoor unit you want to give cool/heat selection permission to as the group master, and set the other outdoor units as group slave units.
- Set SS1 of the External control adaptor for outdoor unit to "BOTH" (factory set) or "C / H." Set SS2 to "OFF" (factory set).

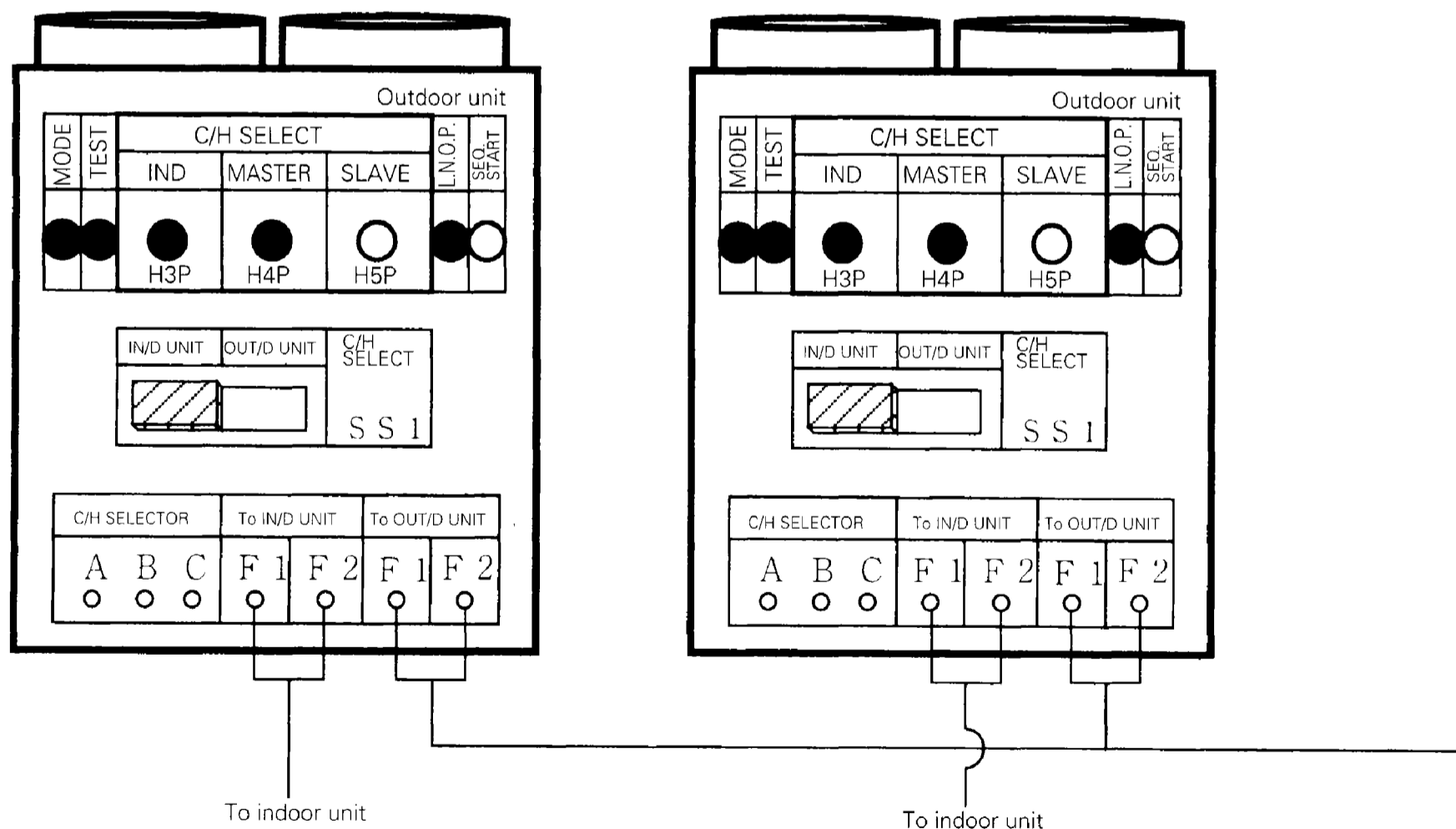
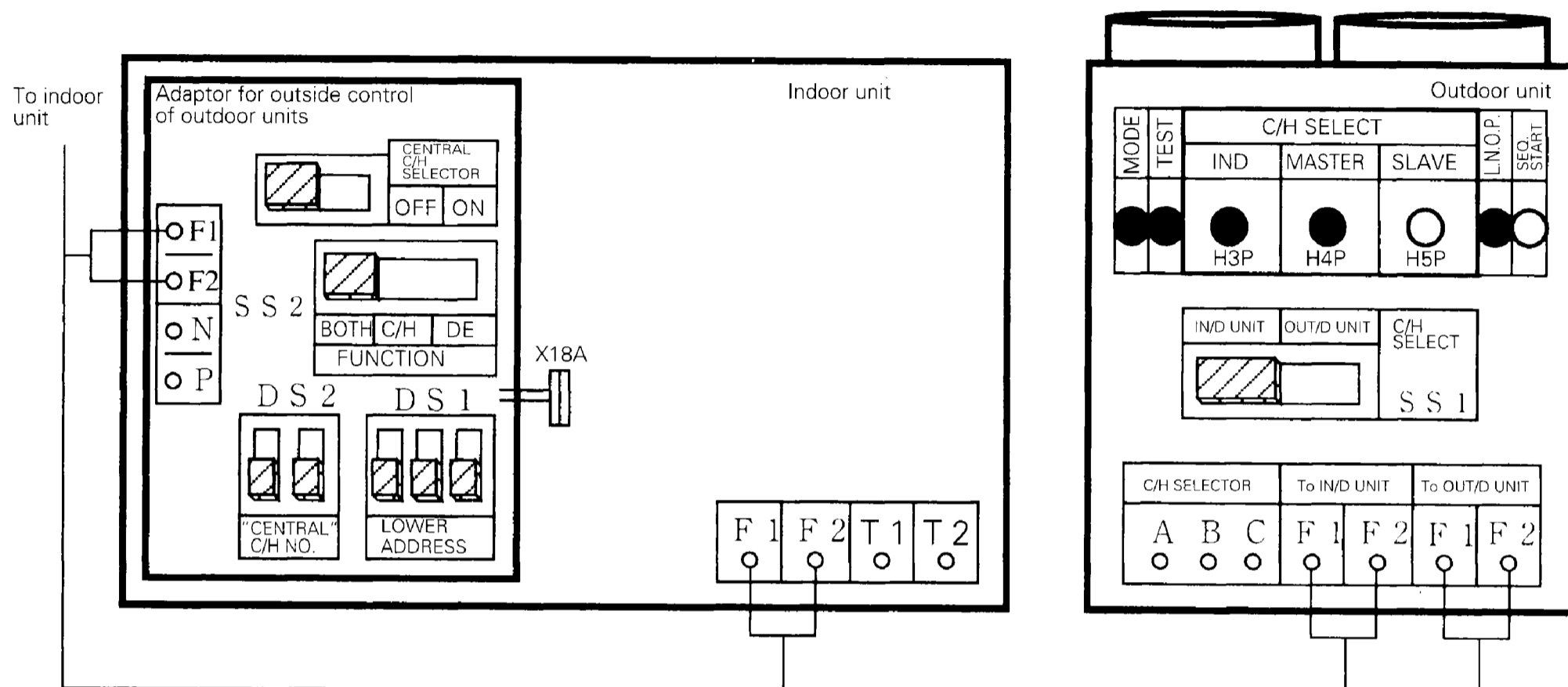

**(4) Setting of cool/heat by outdoor unit system group in accordance with group master outdoor unit by cool/heat selector**

- In addition to (3), change the following:
- Install a cool/heat selector to the group master outdoor unit.
- Set SS1 of the group master outdoor unit's PCB to "OUT / D UNIT."

### Supplement to (3) and (4)

- If using several adaptor PCB and you want to select cool/heat mode for each adaptor PCB, set DS1 / DS2 of the adaptor PCB and the cool/heat group address on the outside unit's PCB to the same setting in setting mode 2.

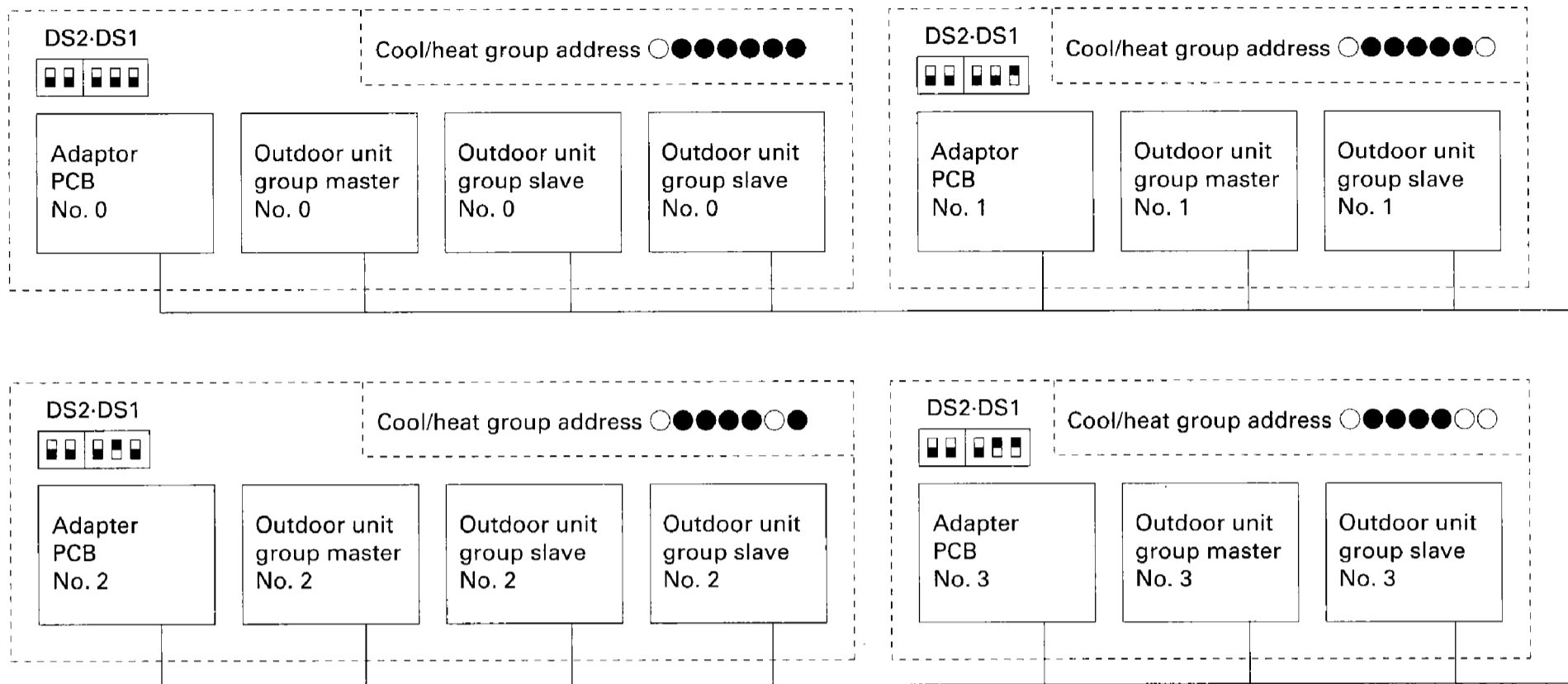

### (3) and (4) address setting method (combine lower 5 digits as binary number)

Address No.	Outdoor unit PC board LED Set in setting mode 2		PC board adaptor					
	DS2	DS1	DS2	DS1	DS1	DS1	DS1	
No 0	○●	●●●●● 0						0
No 1	○●	●●●●○ 1						1
No 2	○●	●●●○● 2						2
No 3	○●	●●●○○ 3						3
No 4	○●	●●○●● 4						4
⋮		⋮						
No30	○●	○○○○● 30						30
No31	○●	○○○○○ 31						31

○ On

● Off

Up (ON)

Down (OFF)

(The black part represents the switch.)



## 7. Low Noise / Demand Operation

External control adaptor for outdoor unit is required for each low noise and demand control zone.

- By using a separate External control adaptor for outdoor unit and setting the outdoor unit address (setting mode 2) for each low noise and demand control zone, demand and low noise operation is carried out in accordance with contact input received from the adaptor in each zone.

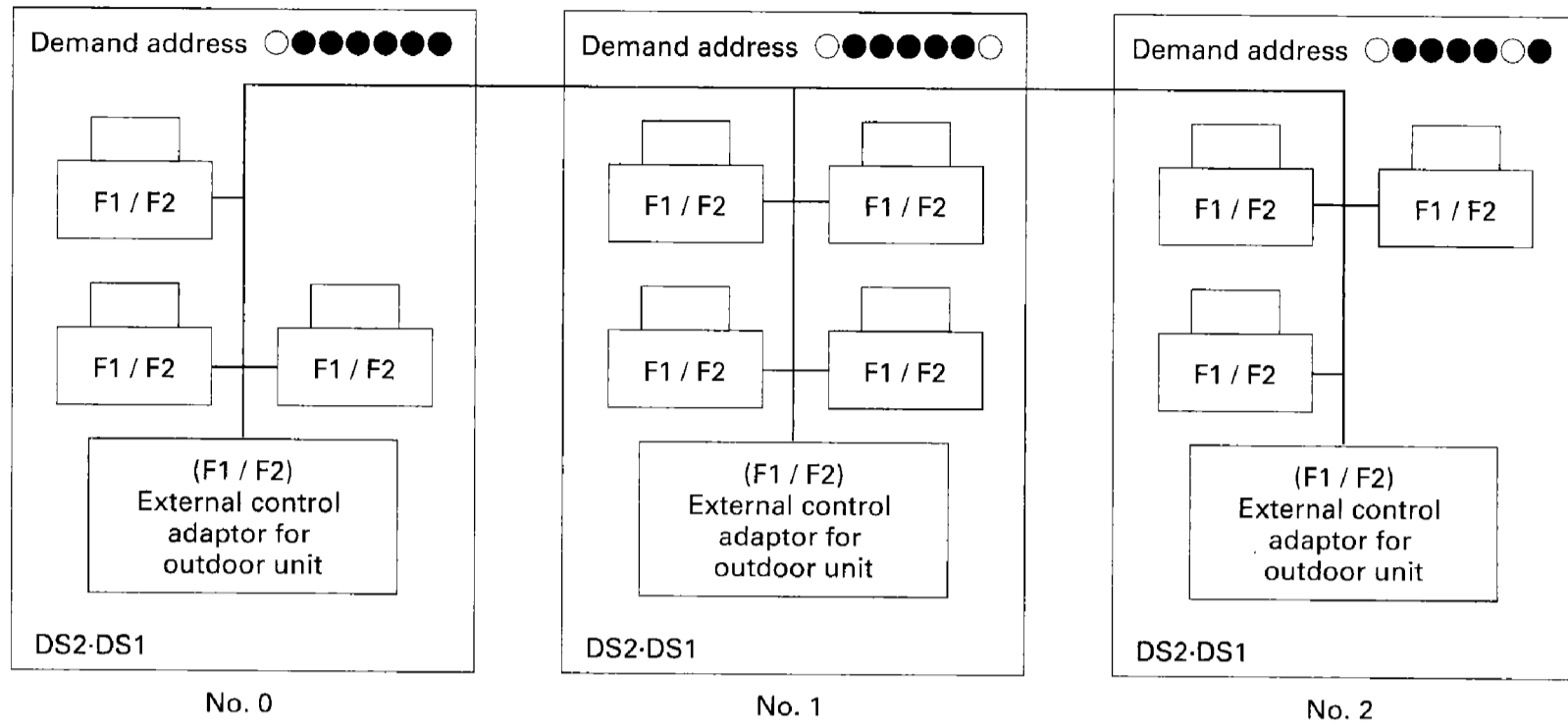

- Outdoor unit address setting (Setting mode 2; see page 42.)
- External control adaptor for outdoor unit address setting
  - Decide and set demand address 0 - 31 for each demand and low noise control zone. (See fig. below.)
  - Set SS1 to "BOTH" (factory set) or "C / H."

Demand No.	Outdoor unit PCB LED Set in setting mode 2	External control adaptor for outdoor unit		No 11	No 12	No 30	No 31
		DS2	DS1				
No 0	○●●●●●●●						
No 1	○●●●●○						
No 2	○●●●○●						
No 3	○●●●○						

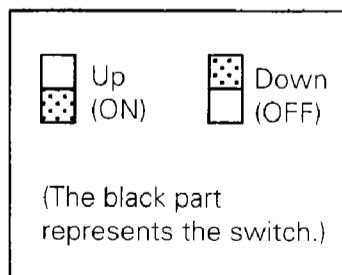
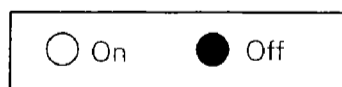

## Wiring method

Wire to the control box for the indoor unit or BS unit. (Note: Differs according to the type of outside control adaptor.)

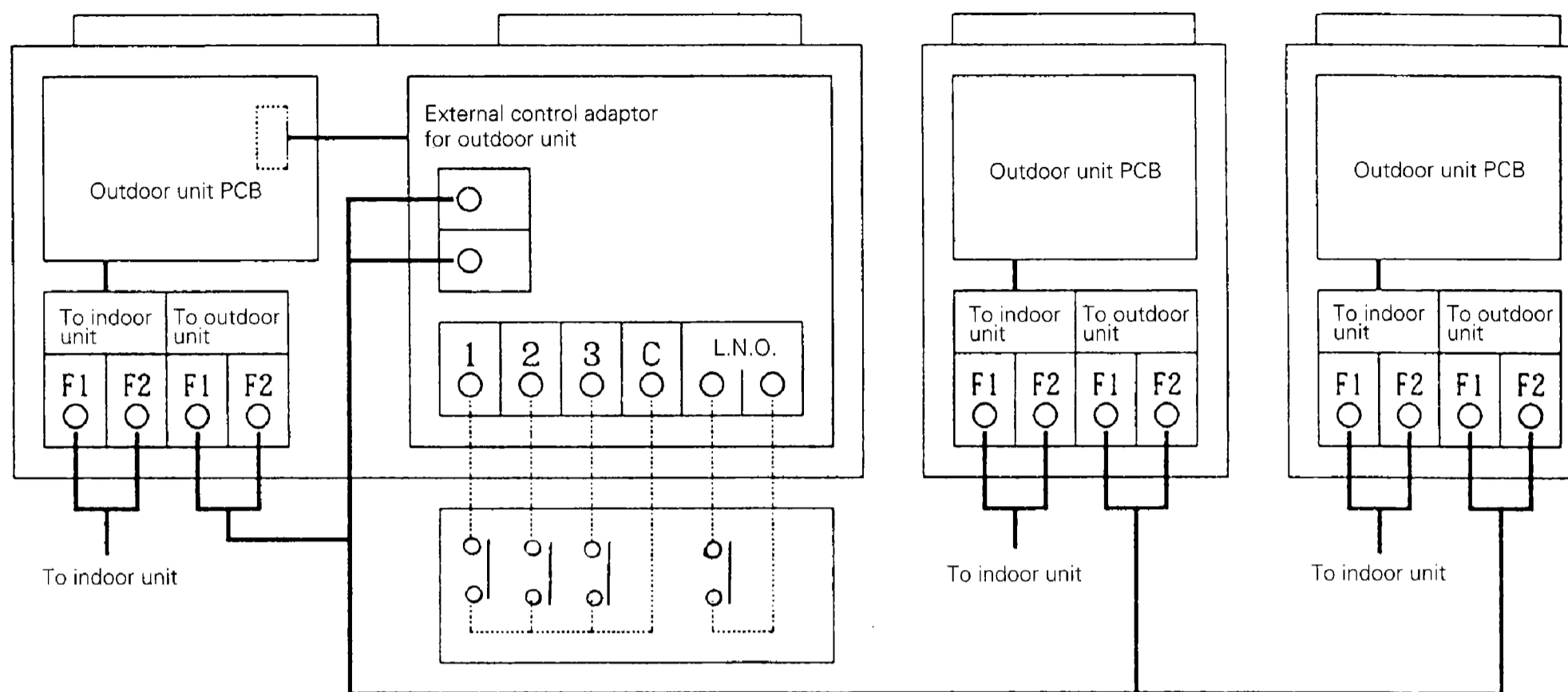

## Demand / low noise input

Short circuit between Demand 1 and C: Holds demand down to approx. 70%

Short circuit between Demand 2 and C: Holds demand down to approx. 40%

Short circuit between Demand 3 and C: Forced OFF by thermostat

L.N.O (jumper): Carries out low noise operation.

## Input signal

Input current by constant contact a is about 10 mA per contact. Use a micro-current contact for the relay contact.

Exterior wiring specifications for demand and low noise operation  
Recommended wiring : Sheathed vinyl cord or cable  
Wiring length : 150 m  
Keep away from power line in order to prevent malfunction.

## 8. Wiring Check Operation

If within 12 hours of stopping cooling or heating, be sure to run all indoor units in the system you want to check in the fan mode for about 60 minutes in order to prevent mis-detection.

### Operation method

1. In the monitor mode, check the number of connected indoor units. (See monitor mode.)
2. Push and hold the WIRING CHECK button (BS4) for 5 seconds to perform wiring check operation.  
While running, TEST (H2P) lights and goes off when finished.  
If TEST (H2P) flickers (wiring check operation failure), push and hold the RESET button (BS5) for 5 seconds, and then repeat the procedure from the beginning.
3. About 1 minute after you finish running the system, once again check the number of connected indoor units in the monitor mode and make sure the number agrees with the first time you checked. If not, it indicates that there is a wiring mistake. Fix the wiring of the indoor unit whose remote controller displays "UF" when its ON/OFF switch is turned ON.

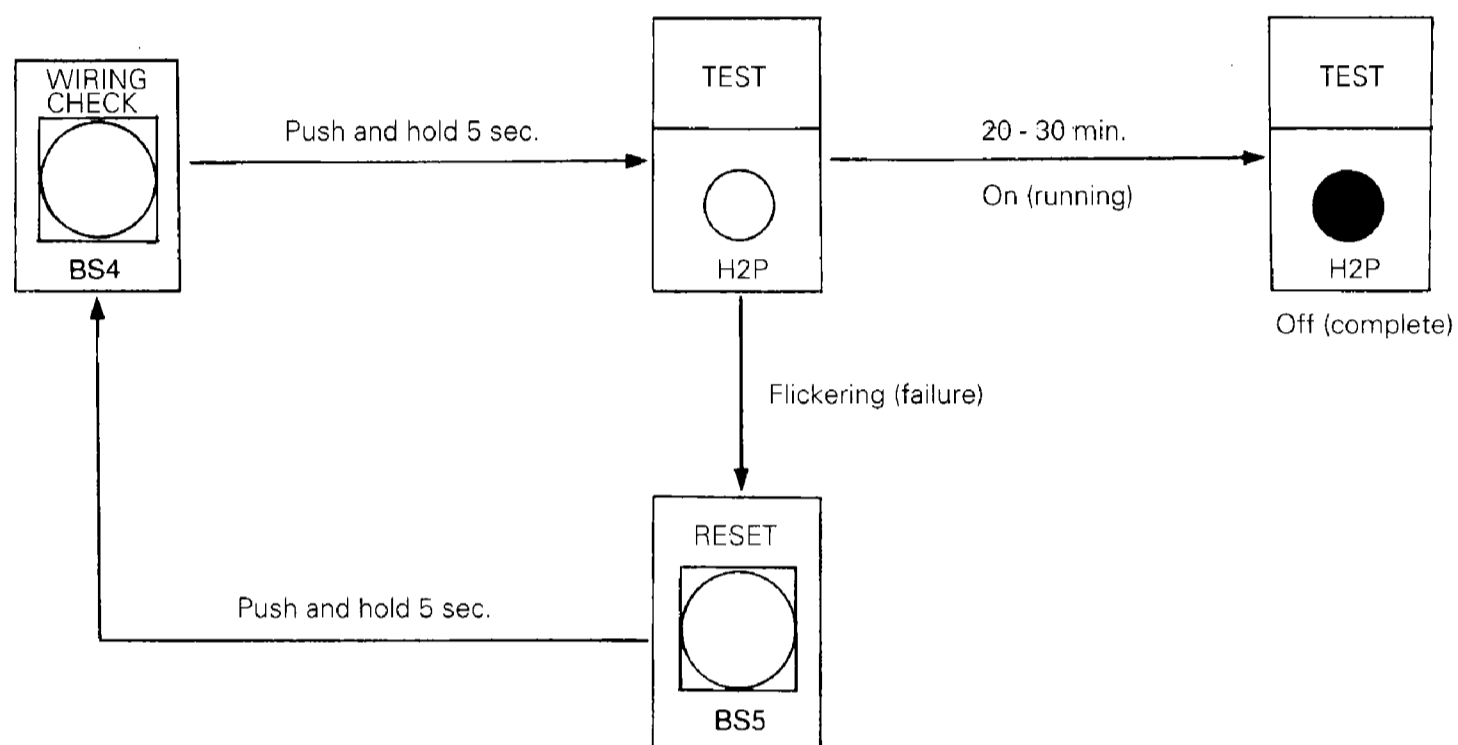

NOTE: Other settings are not accepted during wiring check operation.

## 9. Indoor Unit PCB Ass'y

The indoor unit PCB ass'y is equipped with terminals for control wiring and connectors for optional control accessories . Group No. setting for central control and various operation setting switches, etc., are set by indoor unit remote controller.

Ceiling mounted cassette type (double flow type): FXYC-K

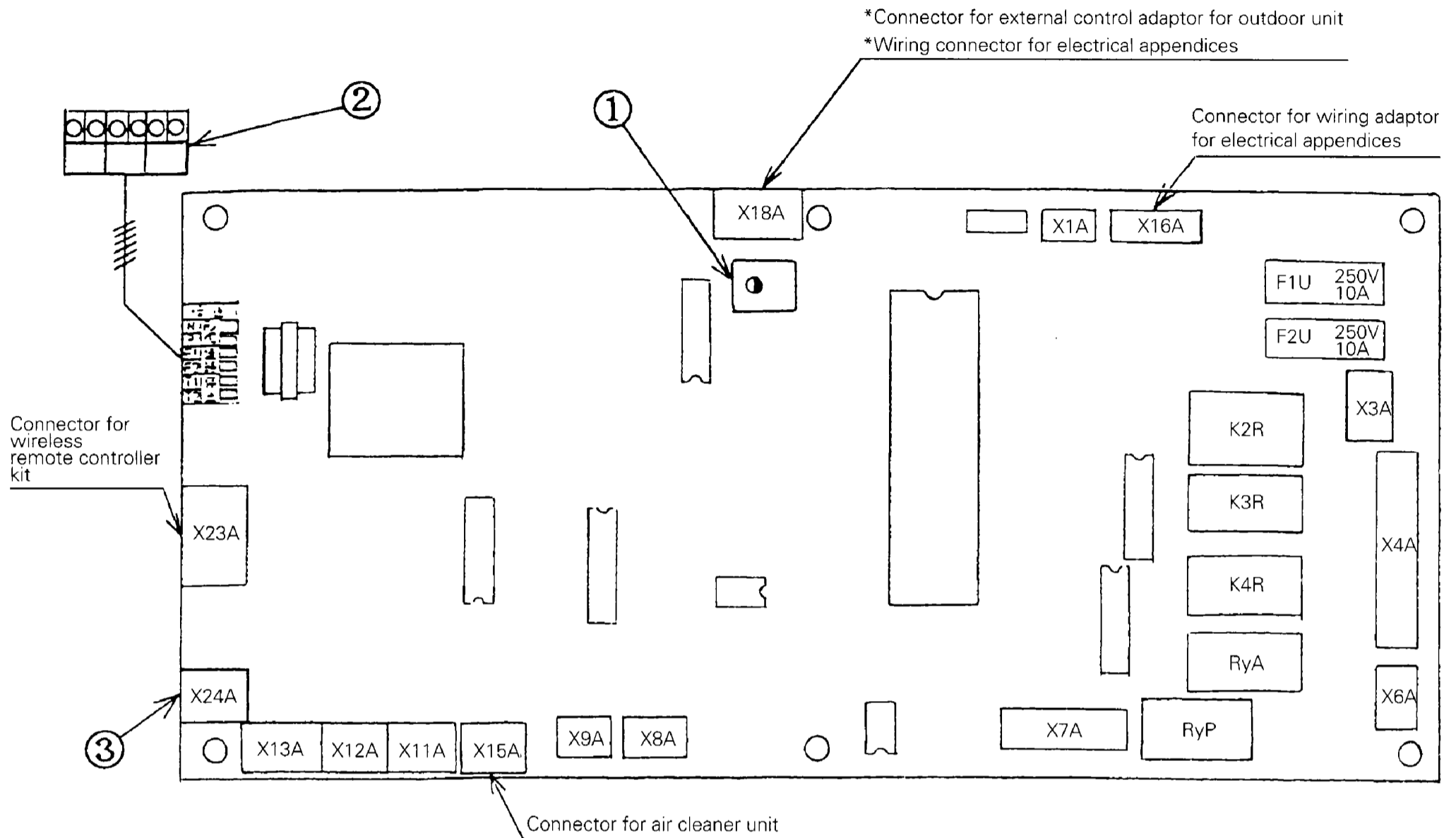

<p>① Service Monitor [HAP] (Green)</p>	<p>Lets you check the function status of the microcomputer. Normal : Flicker Malfunction : On or off</p>												
<p>② Transmission wiring terminal</p>	<p>Terminal for remote controller wiring, indoor - outdoor unit transmission wiring (central wiring), and wiring for outside input</p> <table border="1" data-bbox="1106 1940 1766 2102"> <thead> <tr> <th colspan="2">Remote controller</th> <th colspan="2">Transmission wiring</th> <th colspan="2">Outside input</th> </tr> </thead> <tbody> <tr> <td>N</td> <td>P</td> <td>F1</td> <td>F2</td> <td>T1</td> <td>T2</td> </tr> </tbody> </table>	Remote controller		Transmission wiring		Outside input		N	P	F1	F2	T1	T2
Remote controller		Transmission wiring		Outside input									
N	P	F1	F2	T1	T2								
<p>③ Connector for capacity setting adaptor</p>	<p>Connector for inserting the capacity setting adaptor for when replacing with auxiliary PC board. The adaptor is required for all models. ※Fan phase control for FXYF, FXYH and FXYA only.</p>												

## 10. Remote Controllers (Wired and Wireless)

By making use of optional liquid crystal indoor unit remote controller switches, you can construct a versatile control system. The remote controller control wiring for simplified remote controllers (BRC2A51/3A61) is the same as that of standard remote controllers (BRC1A61/1A62), but since the functions of the simplified remote controllers are limited, we recommend they should be used together with a central remote controller.

### ■ Appearance / functions

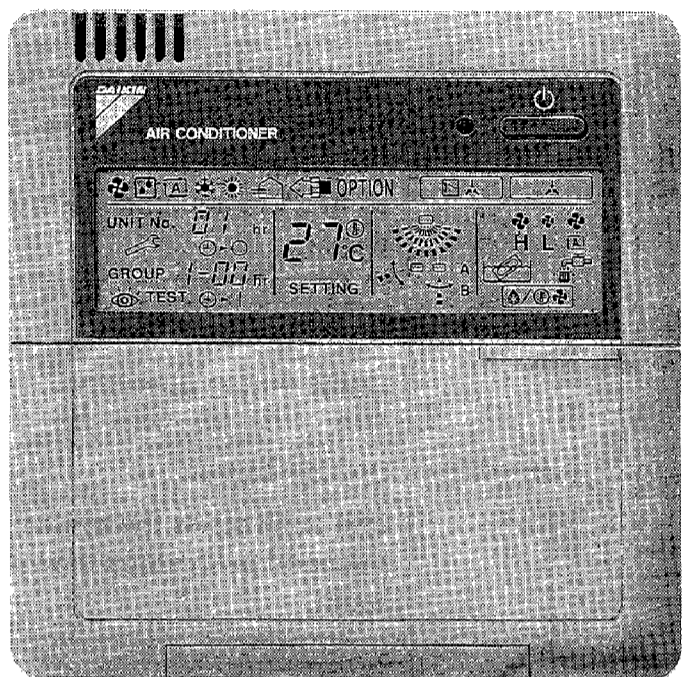

- Large liquid crystal screen that displays operating status in detail.
- Preset temperature is indicated in digital display, and can be set in 1°C increments.
- Enables independent operation without the remote controller for HRV as well as operation interlocked with HRV total heat exchanger units. (Applies only to B Series and multifunctional types)
- Display of malfunction is also available for air cleaner units.
- Operation can be individually programmed to start and stop time up to 72 hours in advance.
- The remote controller is equipped with a thermostat sensor to realize better room temperature control.
- Room temperature and preset temperature are monitored by microcomputer, and cool/heat operation mode is selected automatically. (Applies only to simultaneous cool/heat type only)
- Cool, heat or fan operation mode can be selected by any indoor unit remote controller without using the cool/heat selector switch. (Applies to all VRV System equipment)
- The system can be monitored for malfunctions covering 40 items. Equipped with a "self-diagnosis function" which displays a message to let you know immediately when a malfunction occurs.
- Field settings can be made by remote controller.

### ■ Remote control example

#### ■ Cool/heat operation mode selection control

With the VRV System Inverter K Series, you can select the cool/heat operation mode for outdoor units in the same system with an indoor unit remote controller.

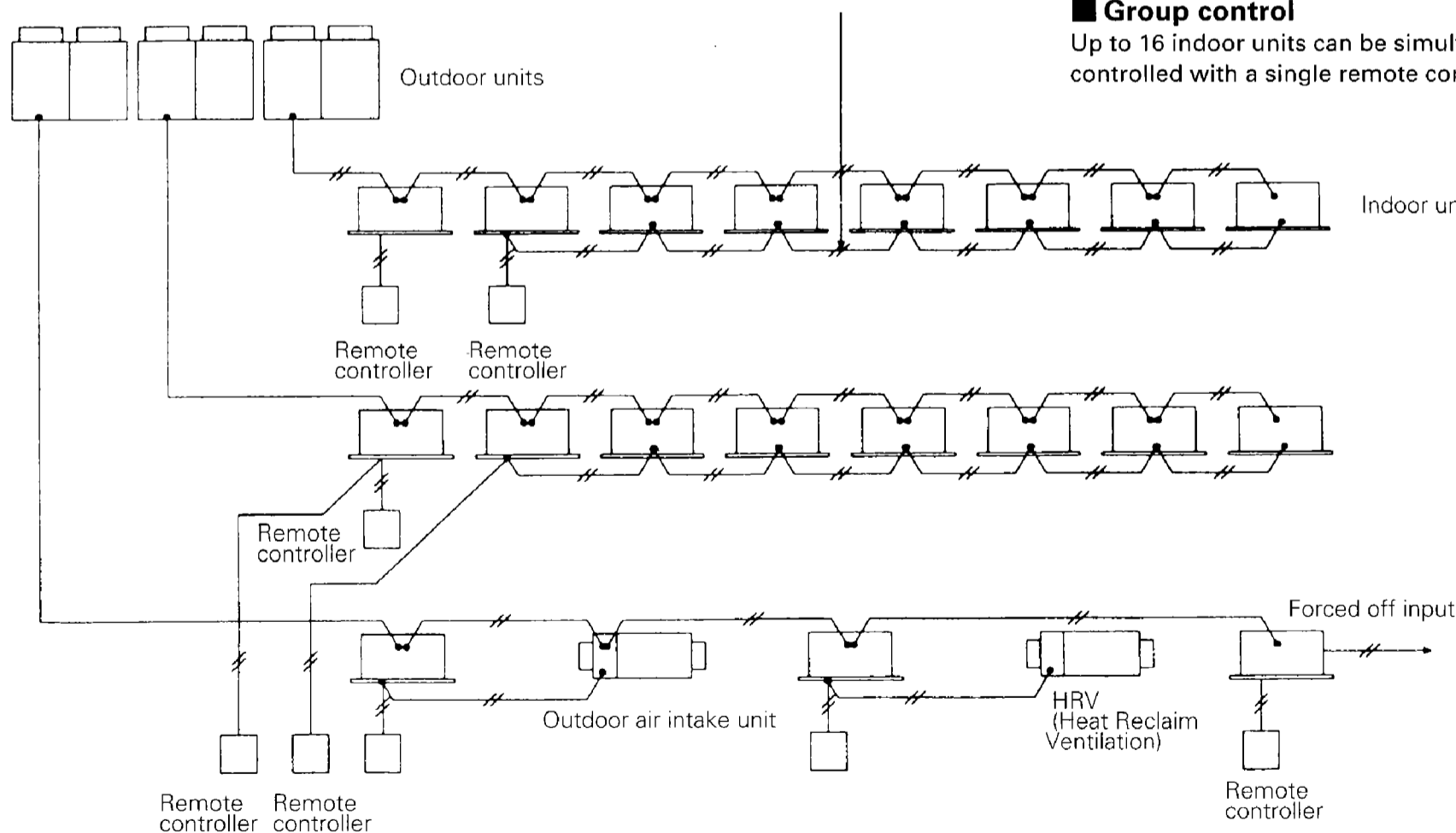

#### ■ Group control

Up to 16 indoor units can be simultaneously controlled with a single remote controller.

#### ■ Control by 2 remote controllers

By connecting two remote controllers to a single indoor unit, you can for instance freely control from both in the room and from the control room (individual control), not to mention that you can carry out group control with two remote controllers.

#### ■ Electrical appendices

Remote controller wiring can be extended up to 500 meters, and you can easily make a central control setup in one place with indoor unit remote controllers set up in various places around the room.

#### ■ Interlock control

You can simultaneously control HRV total heat exchanger units or humidifiers with direct expansion coils via an indoor unit. Also displays cleaning period for air cleaner units.

#### ■ System extension

Allows extension of the system such as a building control system or forced off command input by key control system.

## ■ Applicable remote controller models (wired type)

Model No.	Applicable types
BRCIA61	Ceiling mounted cassette (multi flow, double flow, corner), ceiling suspended, wall mounted
BRCIA62	Ceiling mounted built-in, ceiling mounted duct, concealed floor standing

## ■ Part names and functions

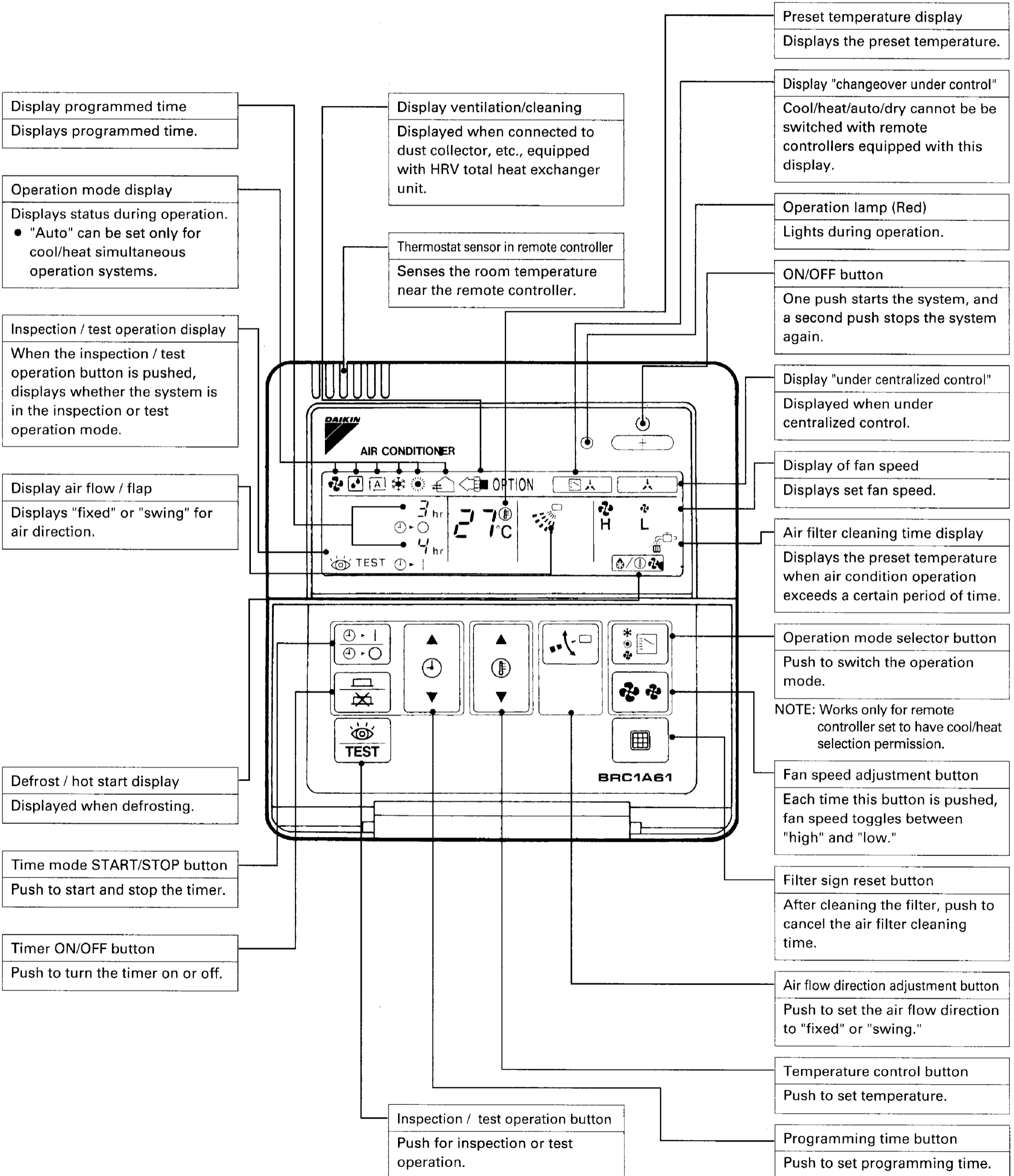

## ■ Applicable wireless remote controller models

Type		FXYC-K	FXYK-K	FXYF-K	FXYS-K	FXYH-K	FXYA-K	FXYL-K FXYLM-K	FXYM-K
Wireless remote controller	H / P	BRC7A62	—	BRC7A61W	BRC4A62	BRC7A63W	BRC7A64W	BRC4A62	BRC4A62
	C / O	BRC7A67	—	BRC7A66W	BRC4A64	BRC7A68W	BRC7A69W	BRC4A64	BRC4A64

## ■ Part names and functions

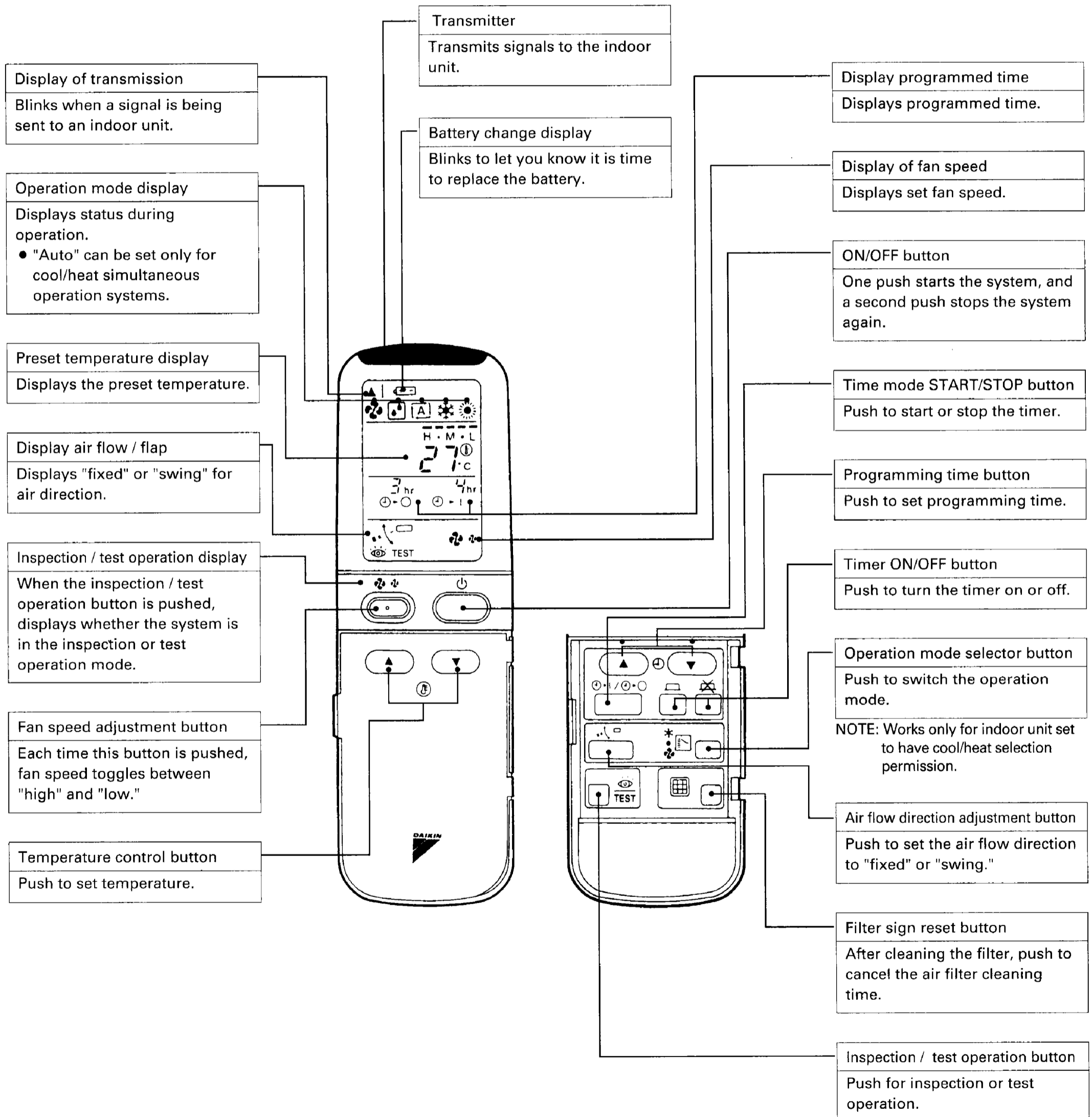

## ■ Example of system using wireless remote controller

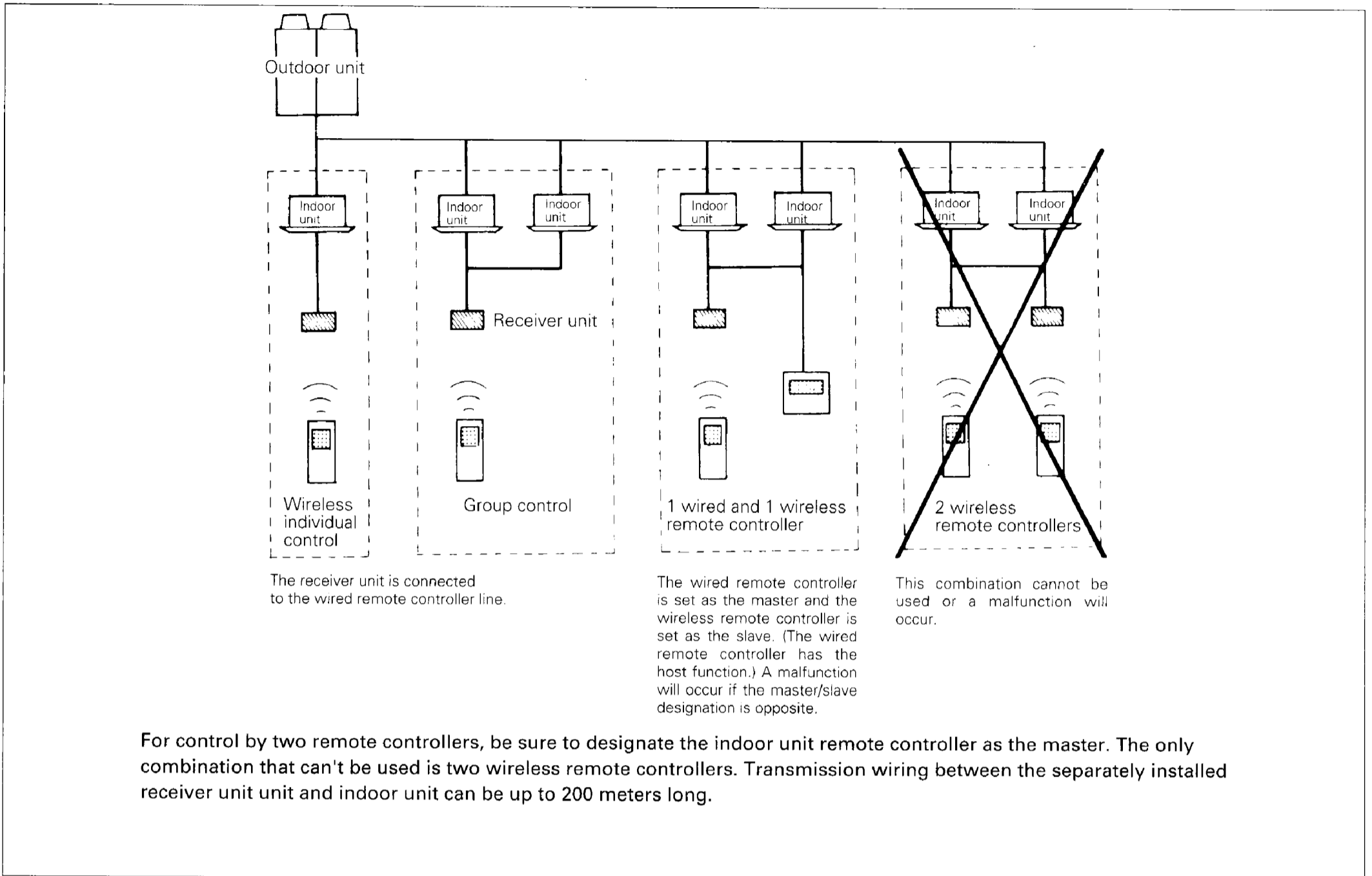

## ■ Comparison of functions of wired and wireless remote controllers

Function /display	Wired remote controller	Wireless remote controller
Operation lamp	Remote controller LED	Receiver unit LED
ON/OFF	Toggles between on and off each time the button is pushed.	
Operation mode selection	Selects operation mode. Cool/heat mode cannot be switched during changeover under control.	Selects operation mode. Cool/heat display switches during changeover under control.
Air flow direction setting	The air flow direction is set by adjusting with the air flow direction adjustment button while viewing setting position in the liquid crystal display.	The air flow direction is set by adjusting with the air flow direction adjustment button while viewing the position of the louver.
Filter sign reset	Resets the filter and element cleaning display.	Resets the filter and element cleaning display. Displayed by optical sensor LED.

※All operation buttons (preset temperature, fan speed, timer, inspection / test operation, cool/heat selection permission and group No. setting for centralized control) function in the same manner.

Function /display	Wired remote controller	Wireless remote controller
·Display "time to clean air cleaner element" ·Filter sign display	Remote controller LCD display	Displayed by receiver unit LED.
Display "ventilation/cleaning"	Displayed when HRV or air cleaner unit is connected.	"Ventilation/cleaning" displayed by receiver unit LED.
Defrost hot start	Displays defrost and hot start.	Displayed by receiver unit LED.
Display "under centralized control"	Displayed during centralized control.	Not displayed, but you are warned by a buzzer sound emitted from the receiver unit .
Display "changeover under control"	Displayed when cool/heat mode cannot be switched.	Not displayed (you are warned by a buzzer sound when the mode cannot be switched).
Thermostat sensor in remote controller	Equipped	Not equipped
Ventilation mode	Equipped	Not equipped



# 11. Control by Remote Controller (Double Remote Controllers, Group, Remote)

■ **Double remote controllers:** Lets you control a single indoor unit using two remote controllers in different locations.

**System which is convenient for cases where for instance you may want to control an indoor unit in the reception room from your office, or when you may want to have fine control of a far away indoor unit at your fingertips. (Applies to other indoor unit types as well.)**

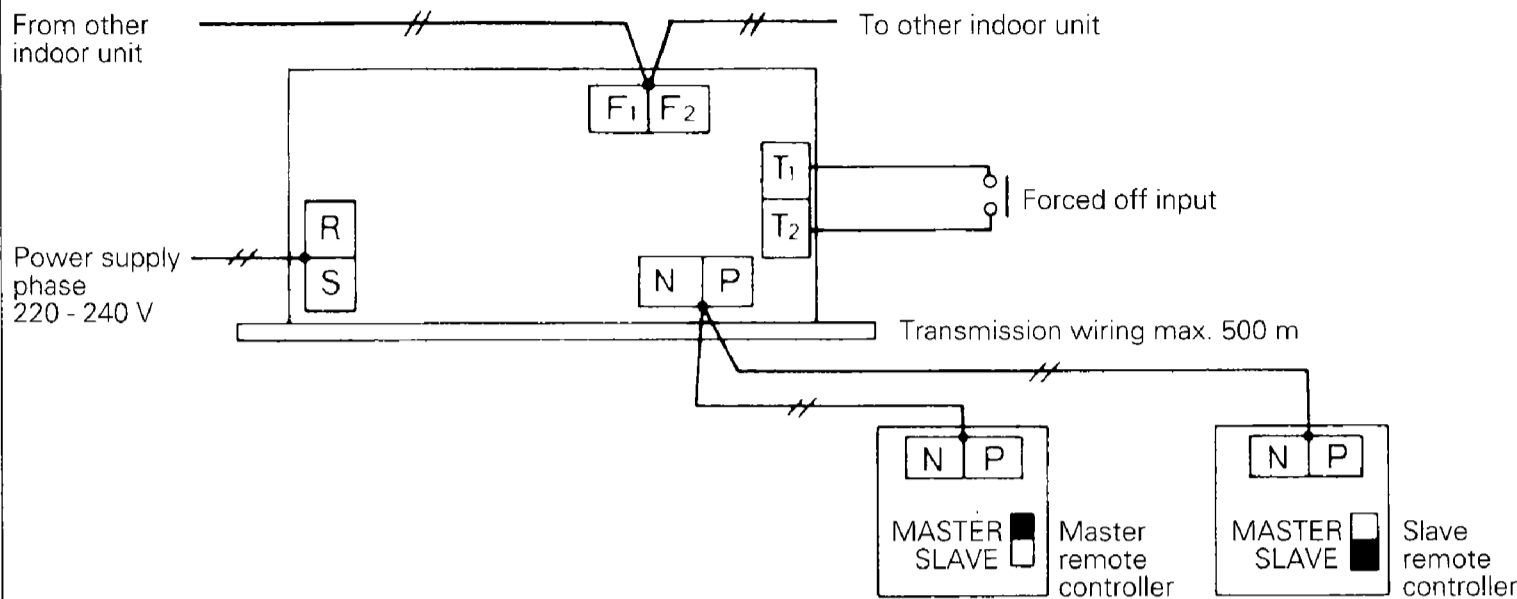

NOTE: The remote controller contains a thermostat sensor. If the master and slave remote controllers are located in different rooms, set field setting to "Not used" by the master remote controller. (No need field setting to "Not used" for the slave remote controller)

- Operation control for indoor units is last command priority.
- Remove the remote controllers' front panels and set the MASTER/SLAVE switch on the remote controller's built-in PC board to MASTER for the master remote controller and SLAVE for the slave remote controller. Field setting can be made only for the master remote controller.

■ **Group control:** Up to 16 indoor units are simultaneously controlled as a group with single remote controller.

**System which is convenient for cases where for instance you may want to simultaneously control several indoor units with the same settings, such as on a huge single floor.**

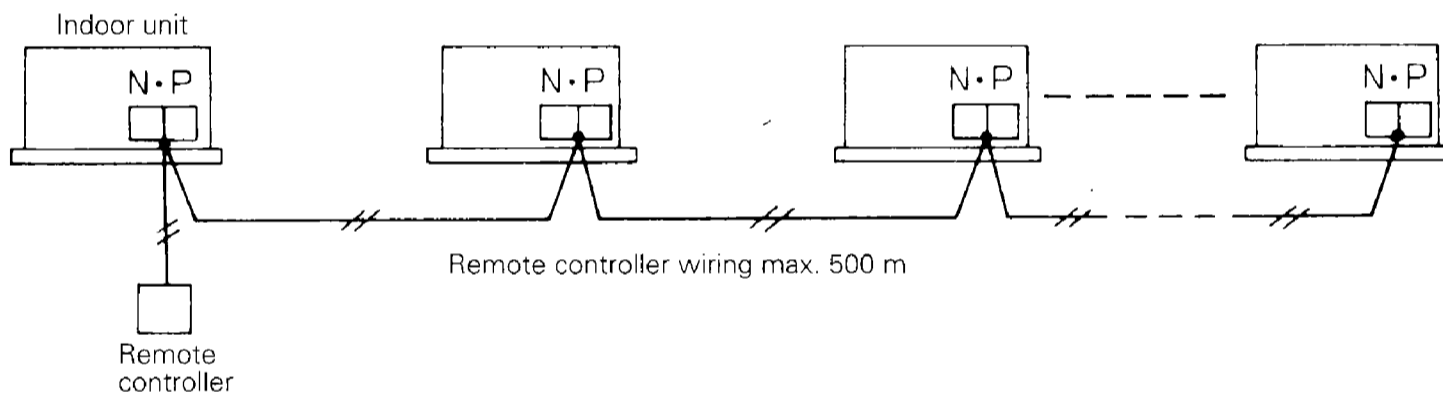

NOTE: Shows remote controller wiring only.

- Remote controller wiring for group control has no polarity, so it doesn't matter if N and P are connected inversely.
- Settings are the same for all indoor units in the group, and each indoor unit is controlled individually by its thermostat sensor.
- Address is set automatically for group control, so there is no need to set the address for by the group control remote controller.

■ **Remote control: Forced OFF or ON/OFF control of indoor units can be input from outside.**

**Enables indoor units to be turned on and off by a building control or key control system.**

### (1) Wiring method and specifications

- Remote control is carried out by connecting input from outside to pins T1 and T2 on the terminal block (for remote controller and transmission wiring)

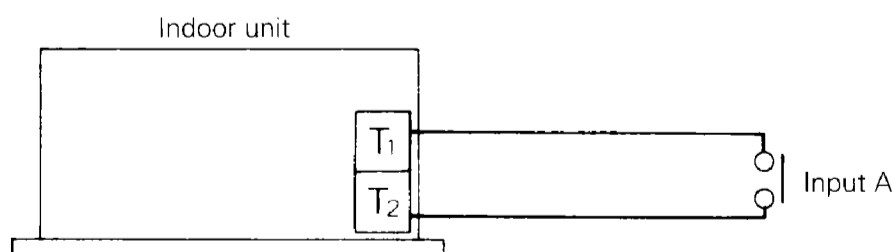

Wiring specifications	Sheathed vinyl cord or cable (double core)
Wiring thickness	0.75~1.25mm <sup>2</sup>
Wiring length	MAX 100m
Outside contact specs.	Contact which guarantees min. applicable load of 15 VDC, 10 mA

Forced OFF	ON/OFF control
Forced OFF by input A "ON" (remote controller prohibited)	On by input A "OFF" → "ON"
Remote controller permitted by input A "OFF"	OFF by input A "ON" → "OFF"

### (2) Operation contents

- Input A of forced stop and stop operation operates as described in the table on the right.

### (3) Forced OFF and ON/OFF control selection

- Switch input by remote controller after turning on the power supply.
- Set field setting mode with the remote controller.
- When you enter the field setting mode, select mode No. 12, and set the first code No. to "1." for forced OFF, set the second code No. to "01," and from ON/OFF control, set to "02." (Factory set is forced OFF.)







## 12. Indoor Field Setting

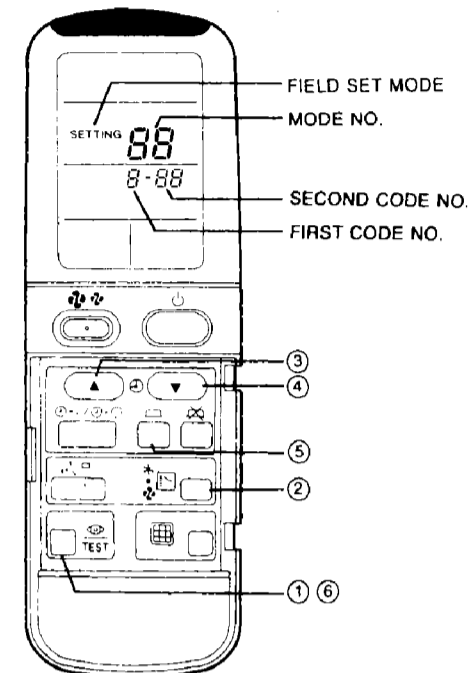
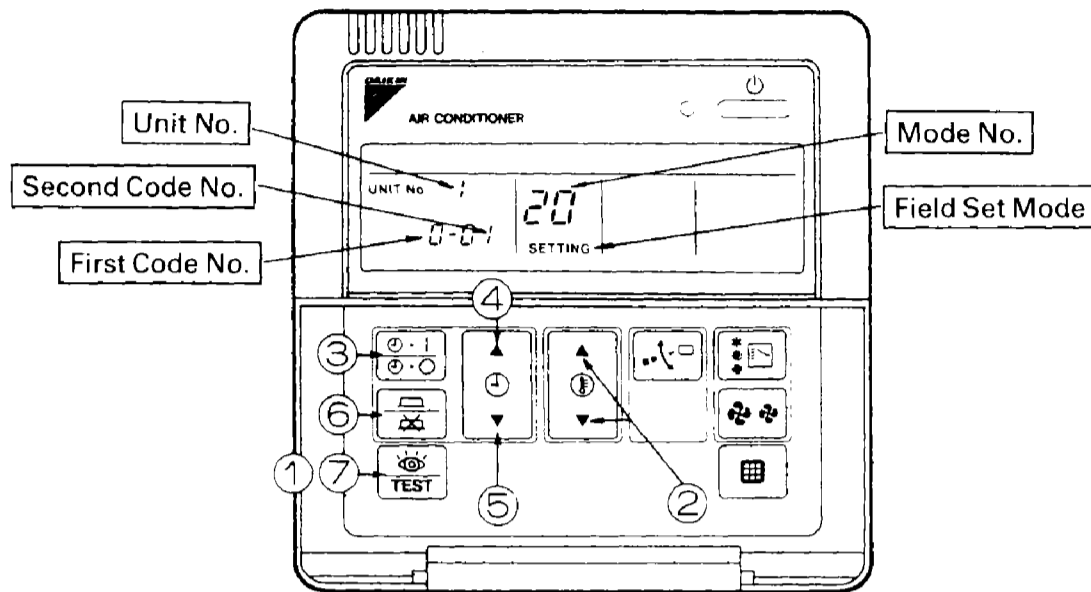



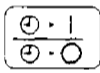

### ☆ Making a field setting

Field settings must be made by remote controller if optional accessories have been installed on the indoor unit, or if the indoor unit or HRV unit's individual functions have been modified.

### ■ Wired remote controller



- ① When in the normal mode, push the  button for 4 seconds or more, and operation then enters the "field set mode."
- ② Select the desired "mode No." with the  button.
- ③ During group control and you want to set by each individual indoor unit (when mode No. 20, 21, 22, 23, 25 has been selected), push the time mode  button and select the "indoor unit No." to be set.  
Note: This operation is not required when setting as a group.
- ④ Push the  button and select the first code No.
- ⑤ Push the  button and select the second code No.
- ⑥ Push the timer  button one time and "define" the currently set contents.
- ⑦ Push the  button to return to the normal mode.

- ① When in the normal mode, push the  button for 4 seconds or more, and operation then enters the "field set mode."
- ② Select the desired "mode No." with the  button.
- ③ Pushing the  button, select the first code No.
- ④ Pushing the  button, select the second code No.
- ⑤ Push the timer  button and check the settings.
- ⑥ Push the  button to return to the normal mode.

- NOTES:
1. Settings are made simultaneously for the entire group, however, if you select the mode No. inside parentheses, you can also set by each individual unit. Setting changes however cannot be checked except in the individual mode for those in parentheses.
  2. The mode numbers inside parentheses cannot be used by wireless remote controllers, so they cannot be set individually. Setting changes also cannot be checked.
  3. Mode numbers 17 (27) and 19 (29) are HRV functions that can be set from a VRV system remote controller.
  4. The second code No. is factory set to "01." The field set air flow direction position and thermostat sensor in remote controller is however set to "02," and ventilation fan speed is set to "05."
  5. Do not make settings other than those described above. Nothing is displayed for functions the indoor unit is not equipped with.
  6. "88" may be displayed to indicate the remote controller is resetting when returning to the normal mode.

● Setting contents and code No.

Mode No. Note 2	First Code No.	Setting Contents	Second Code No.(Note 3)								
			01		02		03		04		
10(20)	0	Filter contamination heavy/light (Setting for display time to clean air filter) (Sets display time to clean air filter to half when there is heavy filter contamination.)	Super long life filter	Light	Approx. 10,000 hrs.	Heavy	Approx. 5,000 hrs.				
			Long life filter		Approx. 2,500 hrs.		Approx. 1,250 hrs.				
			Standard filter		Approx. 200 hrs.		Approx. 100 hrs.				
	1	Long life filter type (FXYC only, 01 indicates long life)	Long life filter		Super long life filter				Soot filter		
2	Thermostat sensor in remote controller	Use		No use							
3	Display time to clean air filter calculation (Set when filter sign is not to be displayed.)	Display		No display							
12(22)	0	Optional accessories output selection (field selection of output for adaptor for wiring)	Indoor unit turned ON by thermostat				Operation output		Malfunction output		
	1	ON/OFF input from outside (Set when ON/OFF is to be controlled from outside.)	Forced OFF		ON/OFF control		External protection device				
	2	Thermostat differential changeover (Set when remote sensor is to be used.) FXYC, FXYE, FXYF, FXYK, FXYH only	1°C		0.5°C						
	3	OFF by thermostat fan speed	LL		Set fan speed						
	4	Automatic mode differential (automatic temperature differential setting for VRV system heat recovery series cool/heat)	01:0	02:1	03:2	04:3	05:4	06:5	07:6	08:7	
	5	Power failure automatic reset	Not equipped		Equipped						
13(23)	0	High air outlet velocity (Set when installed in place with ceiling higher than 2.7 m.) FXYF only	N		H						
	1	Selection of air flow direction (Set when a blocking pad kit has been installed.) FXYF only	F (4 directions)		T (3 directions)		W (2 directions)				
	2	Horizontal air discharge	Equipped		Not equipped						
	3	Air flow direction adjustment (Set at installation of decoration panel.) FXYK only	Equipped		Not equipped						
	4	Field set air flow position setting	Draft prevention		Standard		Ceiling Soiling prevention				
	5	Field set fan speed selection (fan speed control by air discharge outlet for phase control)	Standard		Optional accessory 1		Optional accessory 2				
15(25)	1	Thermostat OFF excess humidity	Not equipped		Equipped						
	3	Drain pump humidifier interlock selection	Not equipped		Equipped						
	4	Sets whether filter sign is to be output by time or by input.	Time addition		Input						
	5	Field set selection for individual ventilation setting by remote controller	Not equipped		Equipped						
	6	Field set selection for individual ventilation setting by remote controller	Not equipped		Equipped						

For HRV settings, see the proper documents for HRV.

# 13. Centralized Control Group No. Setting

## Centralized control group No. setting

- If carrying out centralized control by central remote controller or unified ON/OFF controller, group No. must be set for each group individually by remote controller.
- Group No. setting by remote controller for centralized control

1. When in the normal mode, push the button for 4 seconds or more, and operation then enters the "field setting mode."
2. Set mode No. "00" with the button. ※
3. Push the button to inspect the group No. display.
4. Set the group No. for each group with the button (The group No. increases in the manner of 1-00, 1-01, ..., 1-15, 2-00, ..., 4-15. However, the unified ON/OFF controller displays only the group No. within the range selected by the switch for setting each address.)
5. Push the timer button to define the selected group No.
6. Push the button to return to the normal mode.

- Set the group No. after turning on the power supply for the central remote controller, unified ON/OFF controller, and indoor unit.
  - Group No. setting by wireless remote controller for centralized control
- ① When in the normal mode, push button for 4 seconds or more, and operation then enters the "field set mode."
  - ② Set mode No. "00" with button.
  - ③ Set the group No. for each group with button (advance/backward).
  - ④ Enter the selected group numbers by pushing button.
  - ⑤ Push button and return to the normal mode.

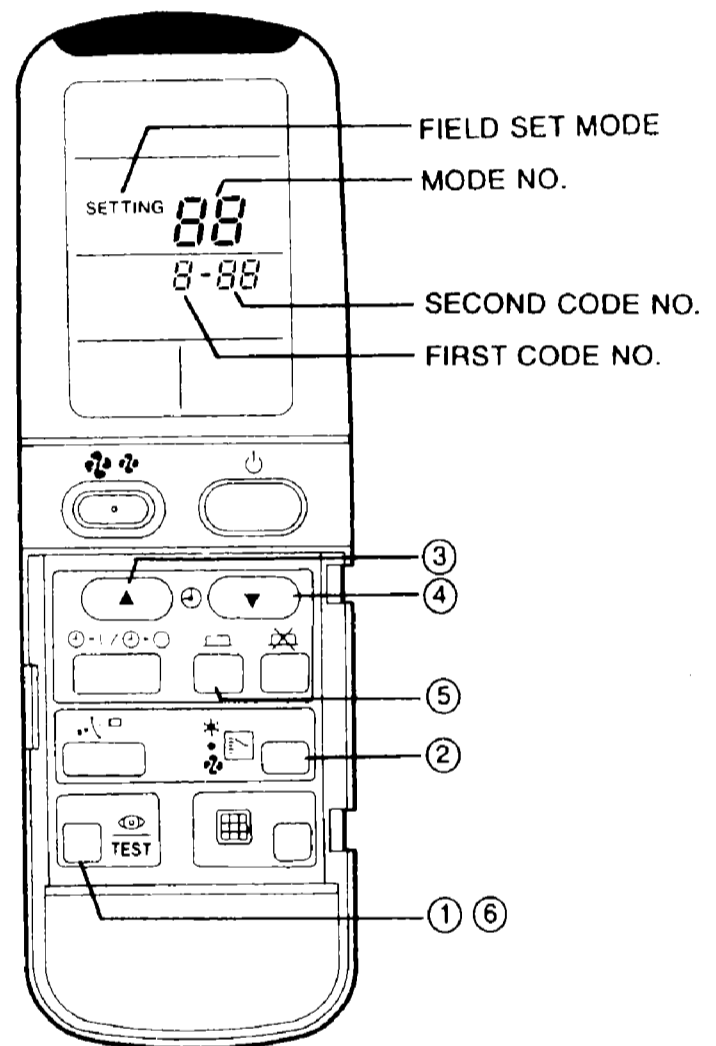
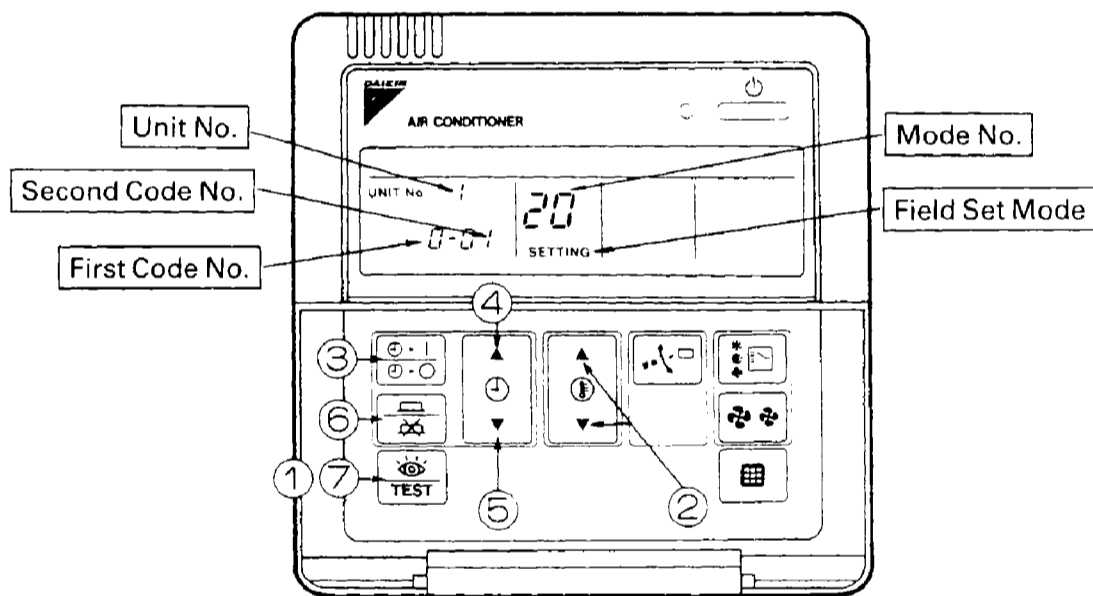

- Even if not using a remote controller, connect the remote controller when setting the group No., set the group No. for centralized control, and disconnect after making the setting.
- Group No. setting example

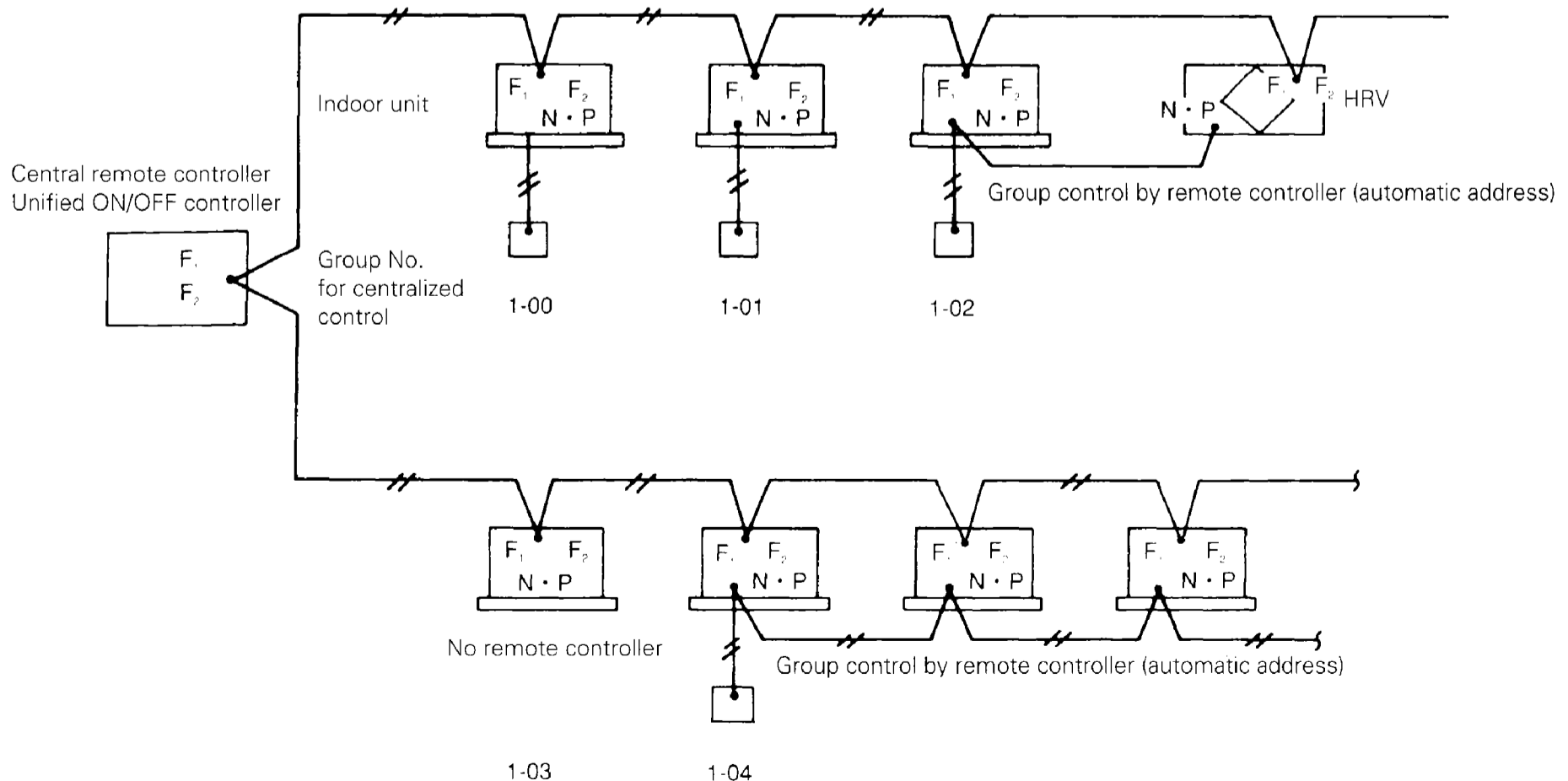

※If you have to set the address for each unit for calculating cost, etc., set the mode No. to "20"

# 14. Setting of Master Remote Controller

## ■ Setting of master remote controller by indoor unit remote controller

- Operation mode (Fan, Dry, Cool, Heat) can be freely selected by indoor unit remote controller for the EX III series outdoor units, however, as shown in the example below, the remote controller of one of the indoor units connected to 1 outdoor unit must be set as the master remote controller for Fan, Dry, Cool, Heat.

(Operation mode can be switched by only the remote controller set as the master remote controller.)

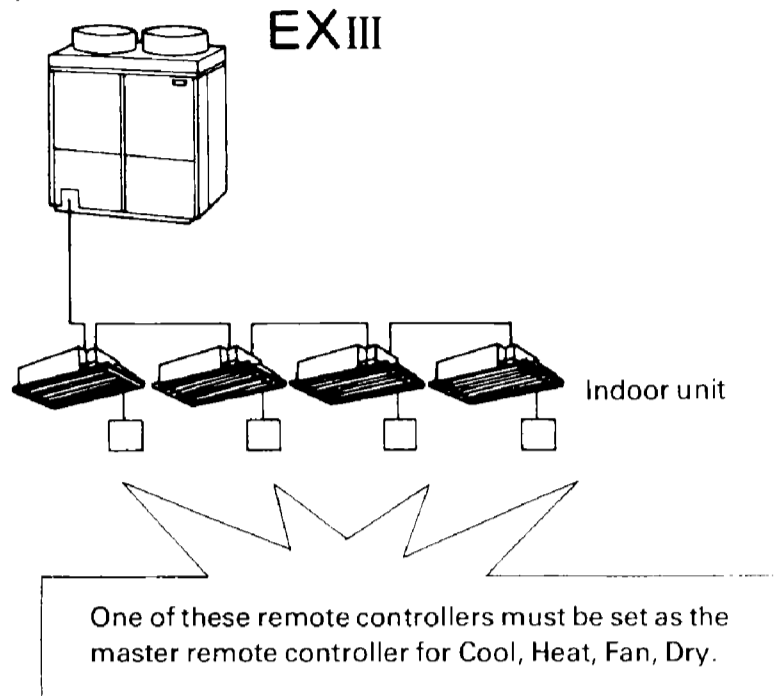

- Setting method

### Preparations

- When turning the power supply on for the first time, the display of **CHANGEOVER UNDER CONTROL** lights when the power supply is turned on.

When you want to set:

<b>1</b>	Set the outdoor unit's cool/heat selector (Field setting mode1) to inside.
----------	--

### Setting of master remote controller

<b>2</b>	Continue pushing <b>OPERATION MODE SELECTOR</b> for about 4 seconds. The display of <b>CHANGEOVER UNDER CONTROL</b> on all remote controllers connected to the same outdoor unit blinks.
----------	---

### Setting of master remote controller

<b>3</b>	Push the <b>OPERATION MODE SELECTOR</b> of the remote controller you want to set as the master remote controller. This completes the setting. The remote controller is now set as the master remote controller and the display of <b>CHANGEOVER UNDER CONTROL</b> goes off. <b>CHANGEOVER UNDER CONTROL</b> is displayed on the other remote controllers.
----------	---

### Operation mode selection

<b>4</b>	Push the <b>OPERATION MODE SELECTOR</b> of the master remote controller (remote controller not displaying <b>CHANGEOVER UNDER CONTROL</b> ) the amount of times required to select the desired operation mode. Each push switches the display from FAN to DRY, COOL, and HEAT. The operation mode changes automatically for all remote controllers that are not set as a master remote controller.
----------	---

- Operation contents and function

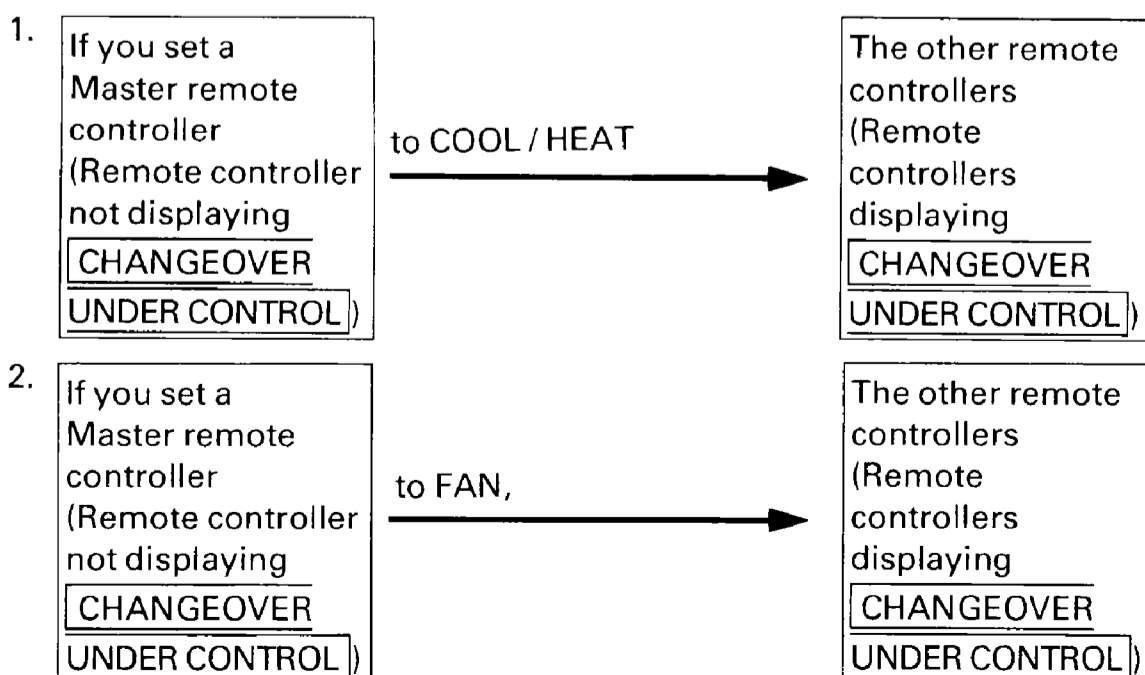

- switch to the operation mode set by the master remote controller.
- However, they can switch to FAN operation and from COOL to DRY.

- cannot set any mode other than FAN.

## 15. Remote Controller Self-Diagnosis Function

The remote controller switches are equipped with a self diagnosis function so that more appropriate maintenance can be carried out. If a malfunction occurs during operation, the operation lamp, malfunction code and display of malfunctioning unit No. let you know the contents and location of the malfunction.

When there is a stop due to malfunction, the contents of the malfunction given below can be diagnosed by a combination of operation lamp, INSPECTION display of the liquid crystal display and display of malfunction code. It also lets you know the unit No. during group control.

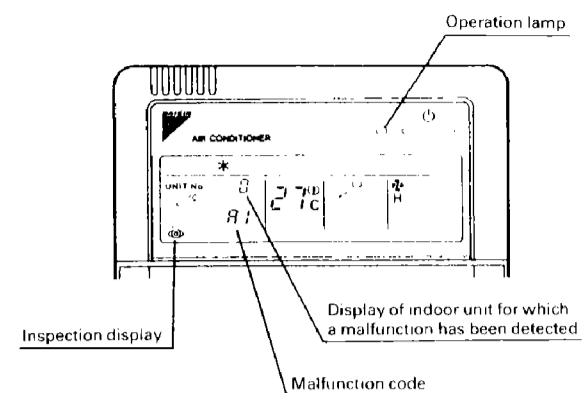



Operation lamp	Inspection display	Unit No.	Malfunction code	Malfunction contents
Blinking	Blinking	Blinking	A0	Indoor unit: Error of external protection device
Blinking	Blinking	Blinking	A1	Indoor unit: Failure of PC board
On	Off	Blinking	A1	Indoor unit: Failure of PC board
Blinking	Blinking	Blinking	A3	Indoor unit: Malfunction of drain level control system (33H)
Blinking	Blinking	Blinking	A6	Indoor unit: Fan motor lock
On	Off	Blinking	A7	Indoor unit: Malfunction of swing flap motor (M1S)
Blinking	Blinking	Blinking	A9	Indoor unit: Malfunction of moving part of electronic expansion valve (Y1E)
On	Off	Blinking	AF	Indoor unit: Drain level above limit
Blinking	Blinking	Blinking	AH	Indoor unit: Malfunction of air cleaner
Blinking	Blinking	Blinking	AJ	Indoor unit: Malfunction of capacity setting
Blinking	Blinking	Blinking	C4	Indoor unit: Malfunction of thermistor (R2T) for liquid pipe (loose connection, disconnection, short circuit, failure)
Blinking	Blinking	Blinking	C5	Indoor unit: Malfunction of thermistor (R3T) for gas pipes (loose connection, disconnection, short circuit, failure)
Blinking	Blinking	Blinking	C9	Indoor unit: Malfunction of thermistor (R1T) for air inlet (loose connection, disconnection, short circuit, failure)
On	On	On	CJ	Indoor unit: Malfunction of thermostat sensor in remote controller
Blinking	Blinking	Blinking	E0	Outdoor unit: Actuation of safety device
Blinking	Blinking	Blinking	E1	Outdoor unit: PC board failure
On	Off	Blinking	E1	Outdoor unit: PC board failure
Blinking	Blinking	Blinking	E3	Outdoor unit: Actuation of high pressure switch
Blinking	Blinking	Blinking	E4	Outdoor unit: Actuation of low pressure switch
Blinking	Blinking	Blinking	E9	Outdoor unit: Malfunction of moving part of electronic expansion valve (Y1E)
Blinking	Blinking	Blinking	F3	Outdoor unit: Abnormal discharge pipe temperature
On	Off	Blinking	H3	Outdoor unit: High pressure switch failure
Blinking	Blinking	Blinking	H4	Outdoor unit: Actuation of low pressure switch
Blinking	Blinking	Blinking	H9	Outdoor unit: Malfunction of thermistor (R1T) for outdoor air (loose connection, disconnection, short circuit, failure)
On	Off	Blinking	H9	Outdoor unit: Malfunction of thermistor (R1T) for outdoor air (loose connection, disconnection, short circuit, failure)
Blinking	Blinking	Blinking	J1	Outdoor unit: Malfunction of pressure sensor
Blinking	Blinking	Blinking	J3	Outdoor unit: Malfunction of discharge pipe thermistor (R3T) (loose connection, disconnection, short circuit, failure)
On	Off	Blinking	J3	Outdoor unit: Malfunction of discharge pipe thermistor (R3T) (loose connection, disconnection, short circuit, failure)
Blinking	Blinking	Blinking	J5	Outdoor unit: Malfunction of thermistor (R4T) for suction pipe (loose connection, disconnection, short circuit, failure)
Blinking	Blinking	Blinking	J6	Outdoor unit: Malfunction of thermistor (R2T) for heat exchanger (loose connection, disconnection, short circuit, failure)
On	Off	Blinking	J6	Outdoor unit: Malfunction of thermistor (R2T) for heat exchanger (loose connection, disconnection, short circuit, failure)
Blinking	Blinking	Blinking	JA	Outdoor unit: Malfunction of discharge pipe pressure sensor
Blinking	Blinking	Blinking	JC	Outdoor unit: Malfunction of suction pipe pressure sensor
On	Off	Blinking	JH	Outdoor unit: Malfunction of oil temperature sensor
Blinking	Blinking	Blinking	L0	Outdoor unit: Failure of inverter system
Blinking	Blinking	Blinking	L4	Outdoor unit: Failure of inverter cooling
Blinking	Blinking	Blinking	L5	Outdoor unit: Compressor motor insulation defect, short circuit, power unit short circuit
Blinking	Blinking	Blinking	L6	Outdoor unit: Compressor motor insulation defect, short circuit
Blinking	Blinking	Blinking	L8	Outdoor unit: Compressor overload, compressor unit wire cut
Blinking	Blinking	Blinking	L9	Outdoor unit: Compressor lock
Blinking	Blinking	Blinking	LA	Outdoor unit: Malfunction of power unit
Blinking	Blinking	Blinking	LC	Outdoor unit: Malfunction of transmission between inverter and outdoor control unit
Blinking	Off	Blinking	PO	Gas depletion (heat build up)
Blinking	Blinking	Blinking	P1	Outdoor unit: Power supply voltage imbalance, open phase
Blinking	Blinking	Blinking	P4	Outdoor unit: Malfunction of power unit temperature sensor
On	Off	Blinking	U0	Refrigerant shortage, low pressure drop due to failure of electronic expansion valve
Blinking	Blinking	Blinking	U1	Negative phase / open phase
Blinking	Blinking	Blinking	U2	Power supply insufficient or instantaneous failure
Blinking	Blinking	Blinking	U4	Malfunction of transmission between indoor unit and outdoor unit / BS unit, or outdoor unit and BS unit
Blinking	Blinking	Blinking	U5	Malfunction of transmission between remote controller and indoor unit
Off	On	Off	U5	Failure of remote controller PC board or setting during control by remote controller

Operation lamp	Inspection display	Unit No.	Malfunction code	Malfunction contents
Blinking	Blinking	Blinking	U7	Malfunction of transmission between indoor units Malfunction of transmission between outdoor units, malfunction of transmission between outdoor unit and ice build-up heat unit
On	Off	Blinking	U7	Malfunction of transmission between outdoor units (cool/heat unified, low noise)
Blinking	Blinking	Off	U8	Malfunction of transmission between master remote controller and slave remote controller (malfunction of slave remote controller)
Blinking	Blinking	Blinking	U9	Malfunction of transmission between indoor unit and outdoor unit in same system Malfunction of transmission between BS unit and indoor/outdoor unit in same system
Blinking	Blinking	Blinking	UA	Failure of combination of indoor / BS / outdoor units (model, No. of units, etc.) Failure of combination of indoor unit and remote controller (applicable remote controller) Failure of BS unit connection position
On	On	On	UC	Address duplication of central remote controller
Blinking	Blinking	Blinking	UE	Malfunction of transmission between indoor unit and central remote controller
Blinking	Blinking	Blinking	UF	System not set
Blinking	Blinking	Blinking	UH	Failure of system

The system operates for malfunction codes indicated in black squares, however, be sure to check and repair.



### Failure diagnosis by wireless remote controller

The indoor unit display section or the separately installed receiver unit's operation lamp blinks for stop due to malfunction. You can diagnose the problem as described on the following page using the malfunction code located by the method described below.

- Push the  button;  is displayed and "0" blinks.
- Push the time mode  button and locate the number of the unit which is stopped due to malfunction. A beep is then emitted to indicate signal reception.

#### • No. of times signal reception beep is emitted

3 times	Perform the procedure given below in the order of 3, 4, 5, 6.
1 time	Perform steps 3 and 6.
Continuous beep	No malfunction

- Push the operation mode selector button, and the upper digit of the malfunction code blinks.
- Push the time mode  button until signal reception beeps twice, and then locate the upper code.
- Push the operation mode selector button, and the lower digit of the malfunction code blinks.
- Push the time mode  button until signal reception beeps continuously, and then locate the lower code.

#### • Continuous signal reception beep indicates that the malfunction code has been ascertained.

Note 1: "INSPECTION" display blinks when the remote controller's  button is pushed.

Note 2: If you push and hold the ON/OFF button for 5 seconds or more in the INSPECTION mode, the failure hysteresis is canceled. In this case, after the malfunction code blinks twice, the code display changes to "00" (normal) and the unit No. changes to "0." The mode then automatically changes from the inspection mode to the normal mode (preset temperature display).

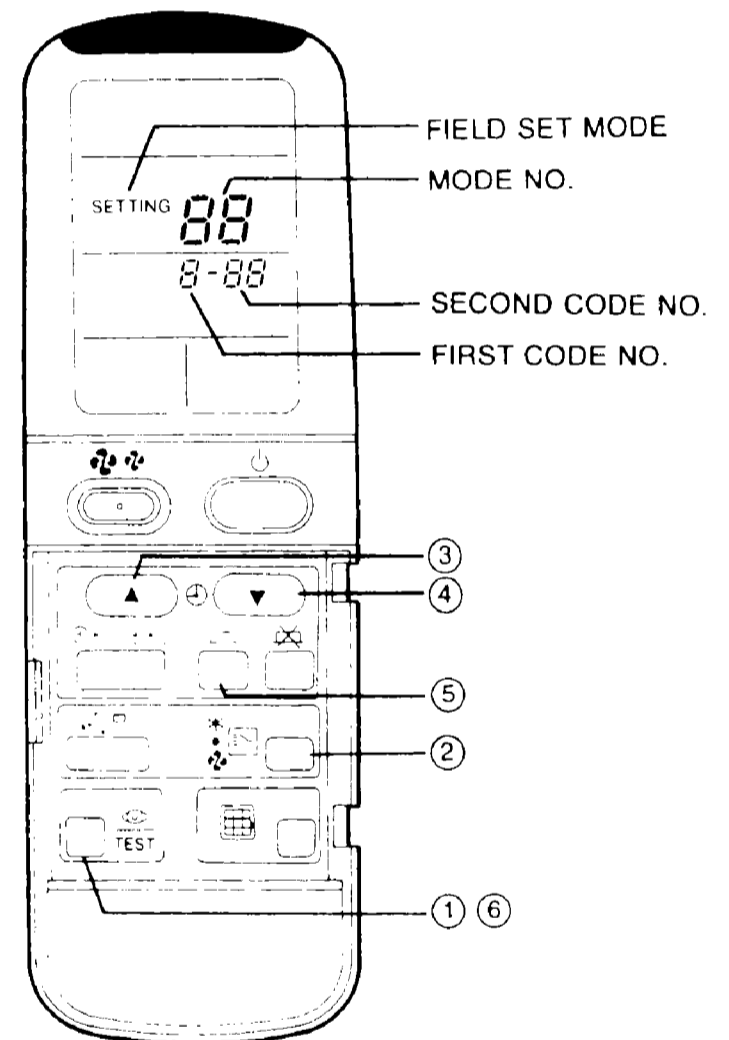

# 16. Operation of the Remote Controller's Inspection / Test Operation Button

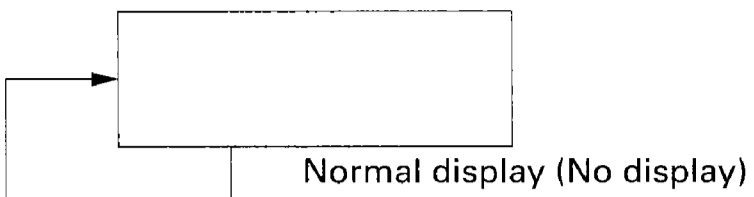

Unit 0  
Malfunction code L 0  
Inspection

Malfunction code blinks when a malfunction occurs.

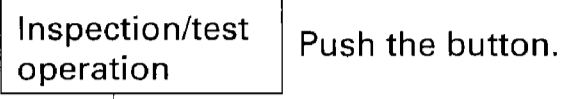

Unit 0  
Malfunction code L 0  
Inspection

Inspection mode

0 7 1... Capacity code  
F... Indoor unit system code  
C... Indoor unit type code  
2... Progression code

Example of capacity code display

Example model	Display
FXYC28K	028
FXYP80K	080

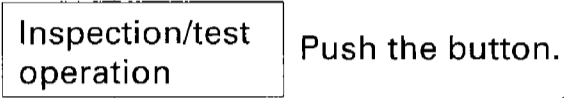

0 7 1  
F C 2

Indoor unit model code display

Indoor unit system code

Display	Product classification	System classification
1	VRV system	(VRV indoor unit)
2	VRV system	Outdoor air intake
F	VRV system	Standard indoor unit

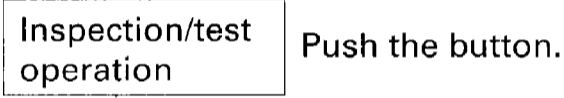

---  
A A 1

Outdoor unit model code display

Indoor unit type code

Display	Type	Model
A	Wall mounted	FXYA
C	Double flow	FXYC
E	Corner	FXYK
F	Multi flow	FXYP
H	Ceiling suspended	FXYH
J	Built-in	FXYS
L	Floor standing	FXYL
U	Concealed ceiling duct	FXYM

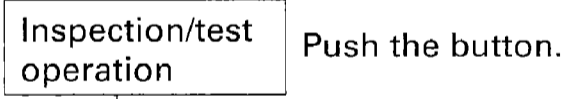

Test operation

Test operation mode

Outdoor model code

Display	Type	Model
A A 1	VRV System Inverter K Series	RSXY
---	Other models (VRV System)	

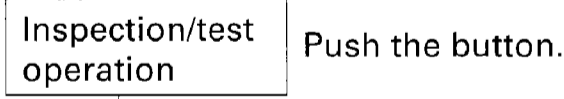







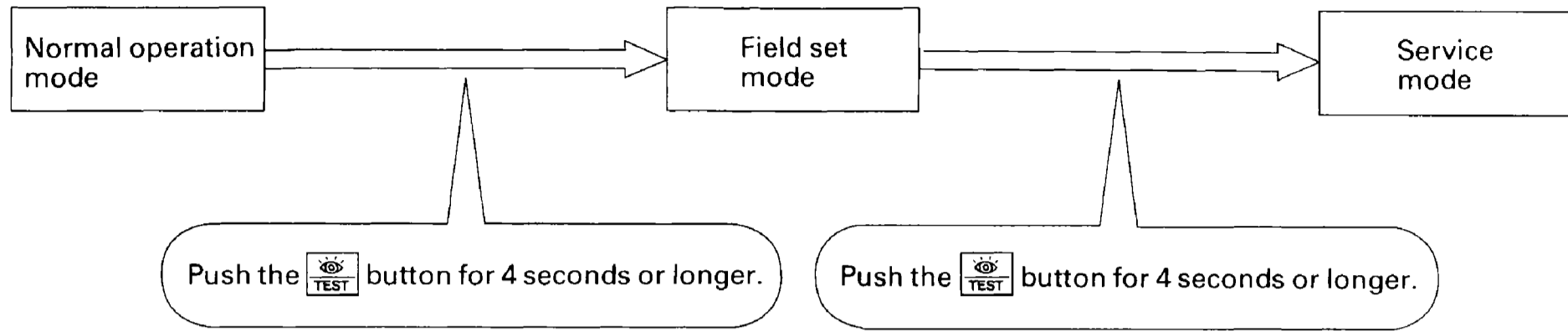





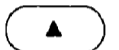

## 17. Remote Controller Service Mode

[How to enter the service mode]

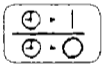

[Service mode operation method]

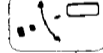
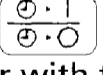
1. Select the mode No.
  - Set the desired mode No. with the  button.
2. Select the unit No. (For group control only)
  - Select the indoor unit No. to be set with the time mode   button.
3. Make the settings required for each mode. (Modes 41, 44, 45)
  - For details, refer to the table below.
4. Define the setting contents. (Modes 44, 45)
  - Define by pushing the timer  button.
5. Return to the normal operation mode.
  - Push the  button one time.

Mode No	Function	Contents and operation method	Remote controller display
40	Malfunction hysteresis display	<p>Display malfunction hysteresis.</p> <p>The hysteresis No. can be changed with the  button.</p>	<p>Unit 1 Malfunction code <b>40</b></p> <p>2-U4 Malfunction code Hysteresis No: 1 - 9 1: Latest</p>
41	Display of sensor and address data	<p>Display various types of data.</p> <p>Select the data to be displayed with the  button.</p> <p>Sensor data 0: Thermostat sensor in remote controller. 1: Suction 2: Liquid pipe 3: Gas pipe</p> <p>Address data 4: Indoor unit address 5: Outdoor unit address 6: BS unit address 7: Zone control address 8: Cool/heat group address 9: Demand / low noise address</p>	<p>Sensor data display</p> <p>Unit No. Sensor type 1 1 2 7 <b>41</b> Temperature °C</p> <p>Address display</p> <p>Unit No. Address 1 8 1 <b>41</b> Address</p>
43	Forced fan ON	<p>Manually turn the fan ON by each unit. (When you want to search for the unit No.)</p> <p>By selecting the unit No. with the  button, you can turn the fan of each indoor unit on (forced ON) individually.</p>	<p>Unit 1 <b>43</b></p>
44	Individual setting	<p>Set the fan speed and air flow direction by each unit</p> <p>Select the unit No. with the time mode  button.</p> <p>Set the fan speed with the  button</p> <p>Set the air flow direction with the  button.</p>	<p>Unit 1 Code <b>44</b></p> <p>Fan speed 1: Low 3: High</p> <p>Air flow direction P0 - P4</p>
45	Unit No. transfer	<p>Transfer unit No.</p> <p>Select the unit No. with the  button.</p> <p>Set the unit No. after transfer with the  button.</p>	<p>Present unit No.</p> <p>Unit 1 Code <b>45</b></p> <p>0 2 Unit No. after transfer</p>
46	This function is not used by VRV System Inverter K Series.		
47			

## 18. Model Change of Centralized Control Devices

The following optional controllers for centralized control will be changed from model A to model B, and will be an upgrade in terms of the system. The main modifications are as follows.

### ■ Main modifications changes (model A to model B)

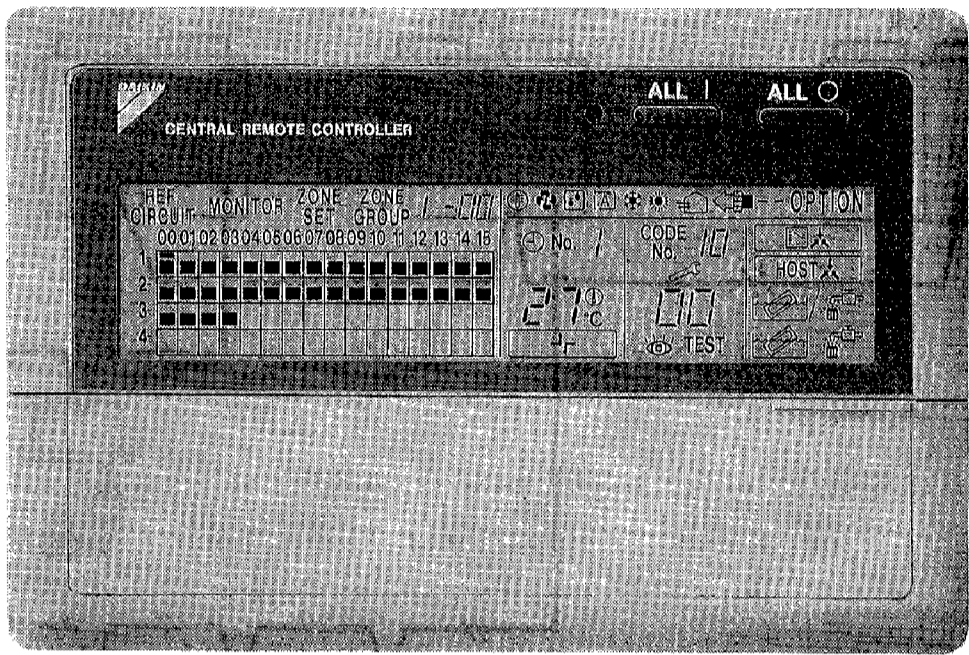
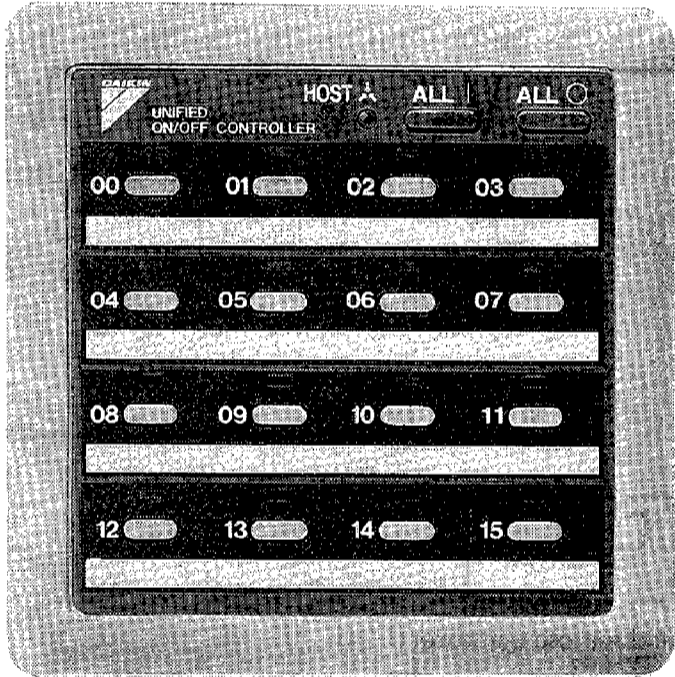
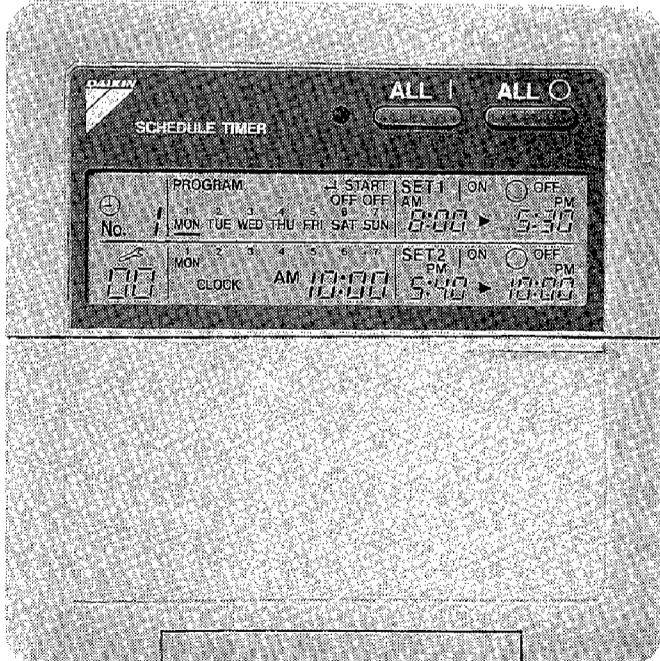
Central remote controller	Model No.	DCS302A51	DCS302B61
	Appearance (Outside dimensions and operation functions are the same.)		
No. of units that can be connected within one control wiring system		1	Up to 2
Unified ON/OFF controller	Model No.	DCS301A51	DCS301B61
	Appearance (Outside dimensions and operation functions are the same.)		
No. of units that can be connected within one control wiring system		Up to 4	Up to 8
Schedule timer	Model No.	DST301A51	DST301B61
	Appearance (Outside dimensions and operation functions are the same.)		
No. of units that can be connected within one control wiring system		1	1
Common	Indoor unit start method	Group start	Sequential start

※ The control range setting (connector or switch) inside the controller is altered to increase the number of units that can be connected within one control wiring system.

■ When using model A centralized control device

- Up to 128 indoor units can be connected within a system. (Group control by remote controller is required if more than 64 units are connected with the same system.)

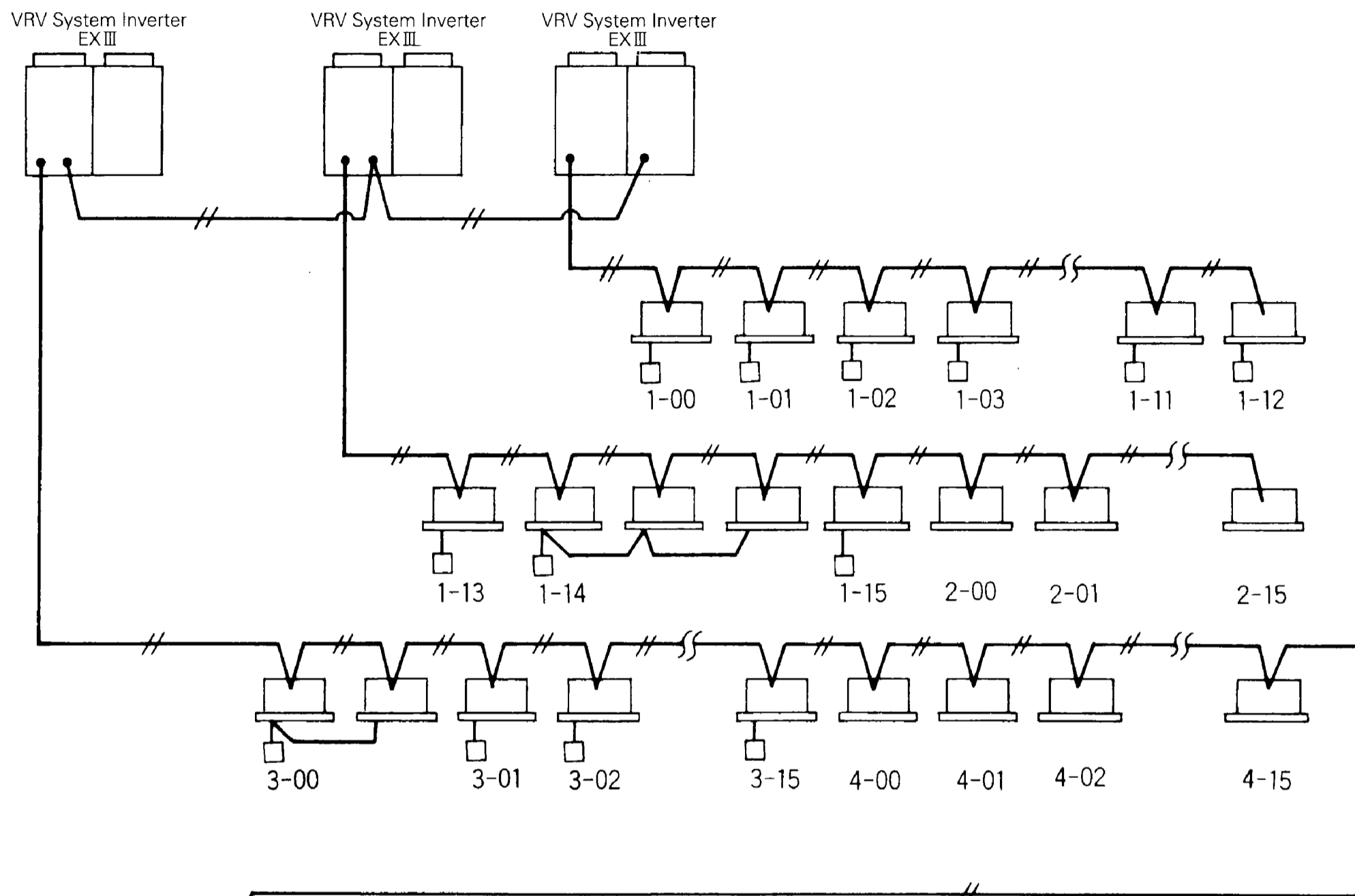

Central remote controller  
DCS302A51

1-00~1-15  
2-00~2-15  
3-00~3-15  
4-00~4-15  
64 groups  
Max. 128 units

- Only 1 central remote controller can be connected per system.
- Up to 4 unified ON/OFF controllers can be connected per system.
- Only 1 schedule timer can be connected per system.

■ **When using model B centralized control device**

- Up to 128 indoor units can be connected within a system. (Group control is not required to increase the number of units that can be connected within the system.)
- When double remote controllers are connected, the same indoor unit cannot be registered for more than one central remote controller.

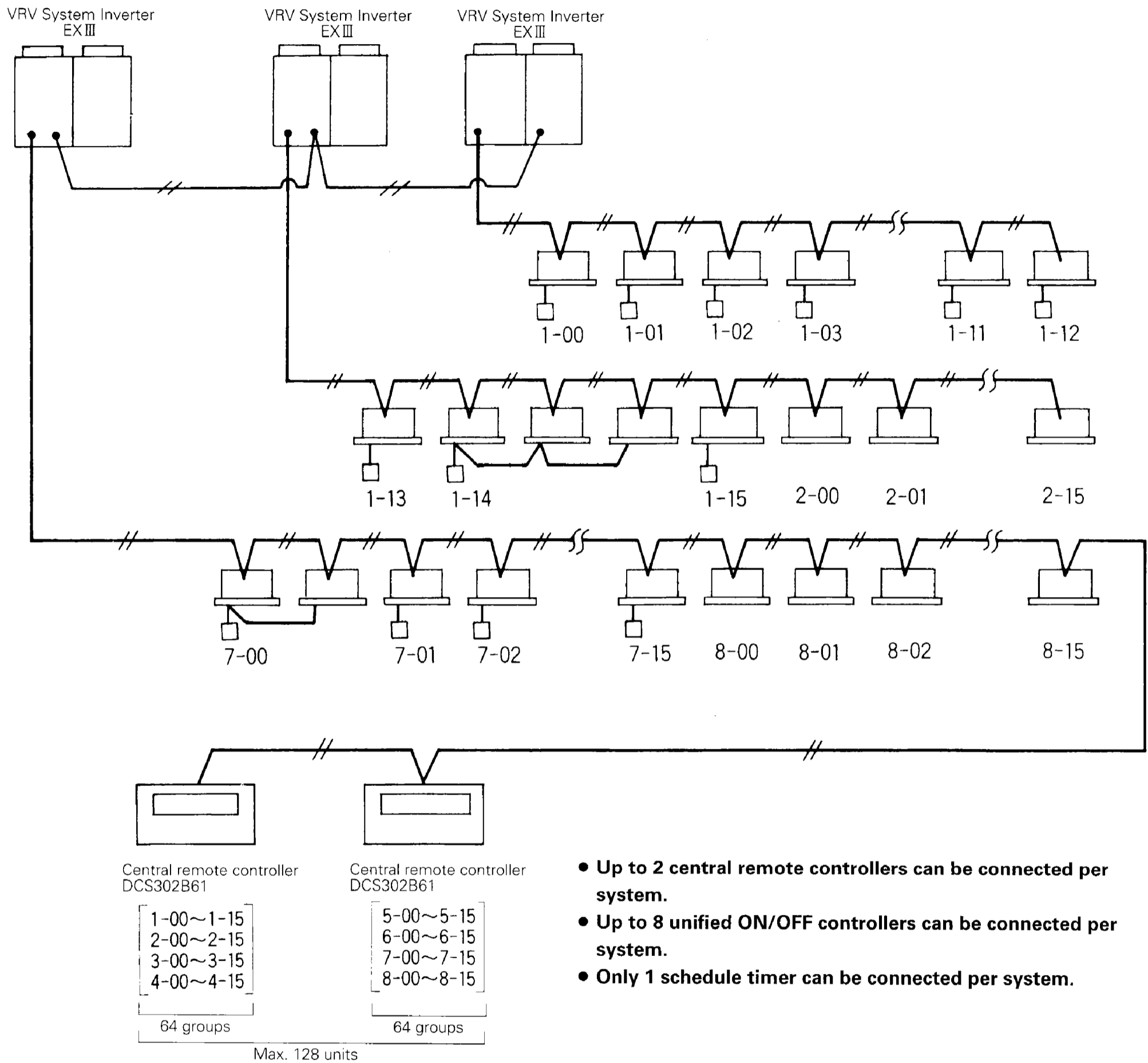

# 19. Central Remote Controller (DCS302A51 / DCS302B61)

Enables central control with the performance of a series of remote controllers by connecting with up to 64 groups of indoor units (128 units).

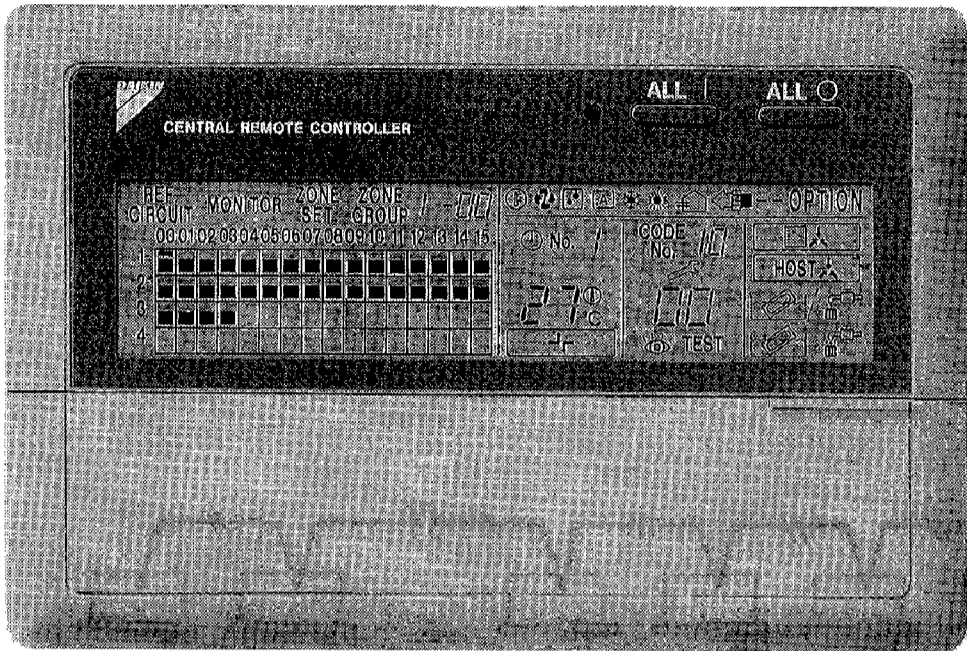

- You can connect with up to 64 groups of indoor units (128 units) and monitor or perform operations such as turning on/off individually or simultaneously, setting temperature, etc., by the zone.
- Designed to save labor of operation, and is able to execute zone control for up to 64 zones.
- Malfunction contents are given in code, so maintenance or inspection can be carried out quickly.
- Lets you connect 1 schedule timer and 4 unified ON/OFF controllers per central remote controller, and enables you to freely expand the central control system in accordance with scale and use.
- Wiring can be extended up to 1 km. Besides crossover wiring, bus or star type can also be used.
- Can be used in combination with other D-BACS equipment and allows input from outside of forced OFF, etc.
- Enables individual on/off and monitoring of total heat exchanger units (HRV) (model B Series and multifunction type).

## System Configuration

With a central remote controller, you can simultaneously turn up to 64 groups of indoor units on or off (up to 128 units). You can also turn on or off, set operation and control modes such as operation controlled by timer, make operation by remote controller possible or impossible, and control or display operation conditions such as preset temperature by zone. (Case where operation controlled by timer is used in combination with schedule timer.) By group, you can display operation conditions such as operation mode and preset temperature. Connection by forced OFF input (non-voltage a contact) with outside key system or host computer monitor panel is impossible.

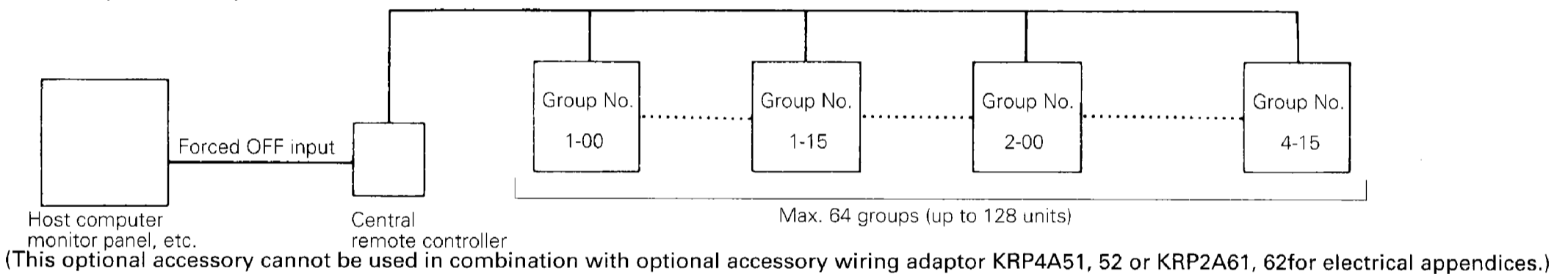

(This optional accessory cannot be used in combination with optional accessory wiring adaptor KRP4A51, 52 or KRP2A61, 62 for electrical appendices.)

A group of indoor units is as described below.

(1) 1 indoor unit with no remote controller

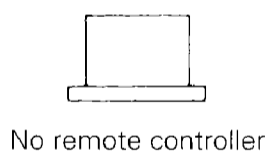

(2) 1 indoor unit controlled by either 1 or 2 remote controllers

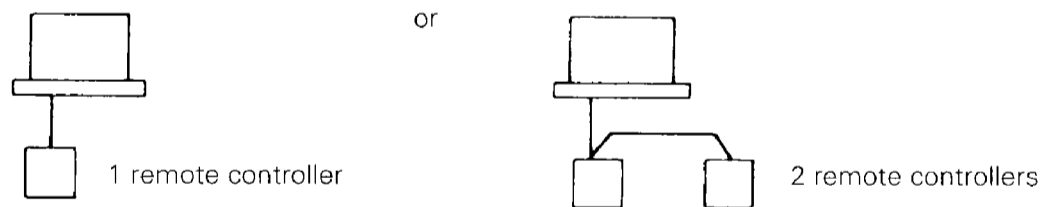

(3) Max. 16 indoor units controlled by either 1 or 2 remote controllers

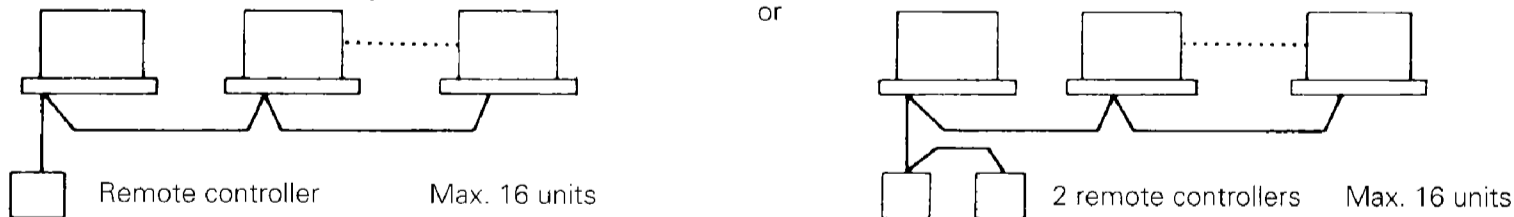

• **Zone control by central remote controller (A "zone" is a collection of 1 or more groups.)**

• Zone control lets you make settings for several groups simultaneously in order to facilitate the task of setting.

By setting once, everything in the zone becomes set to the same setting. The number of zones that can be set by the central remote controller is MINI~MAX 64 zones. (The number of groups in 1 zone is MINI~MAX 64 groups.) The manner of linking zones can be set as desired with the central remote controller.

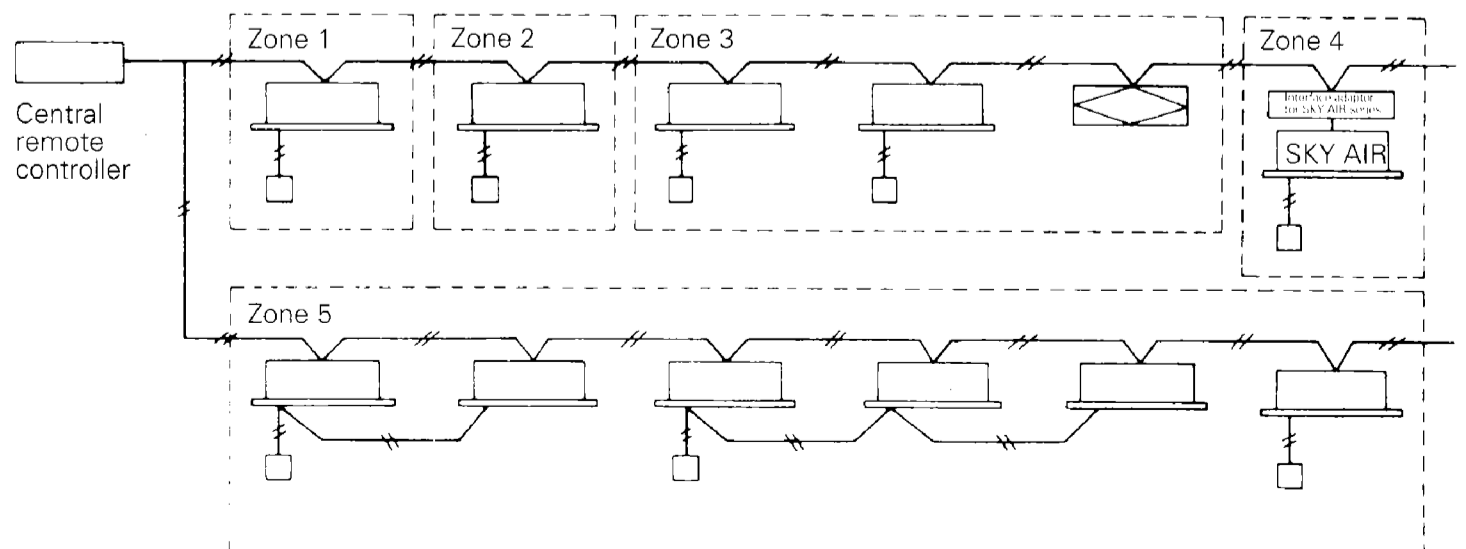

## Central remote controller part names and functions

- Display section (All items in the display are lit for the purpose of explanation, contrary to when actually operating.)

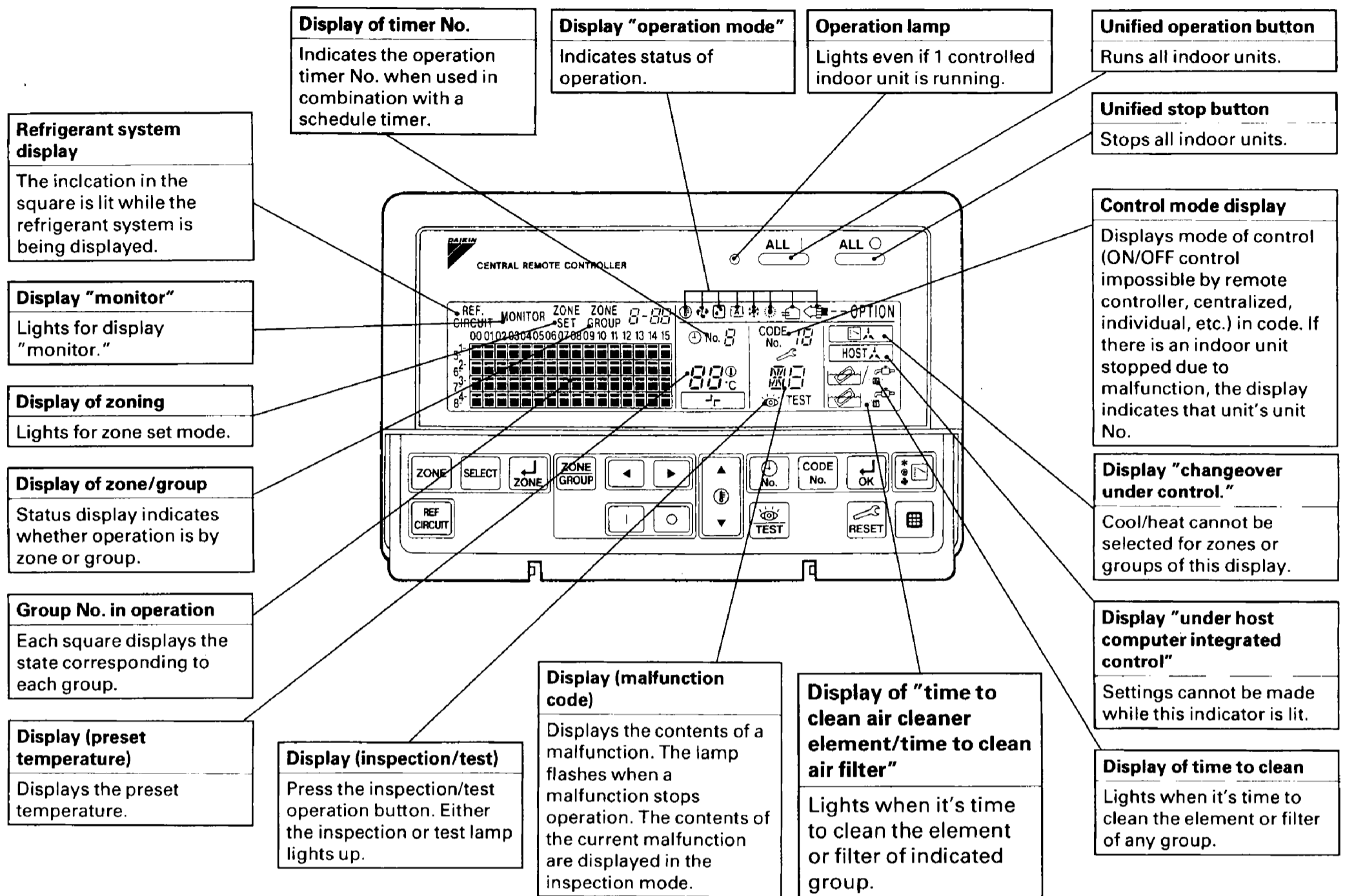

- Control Section

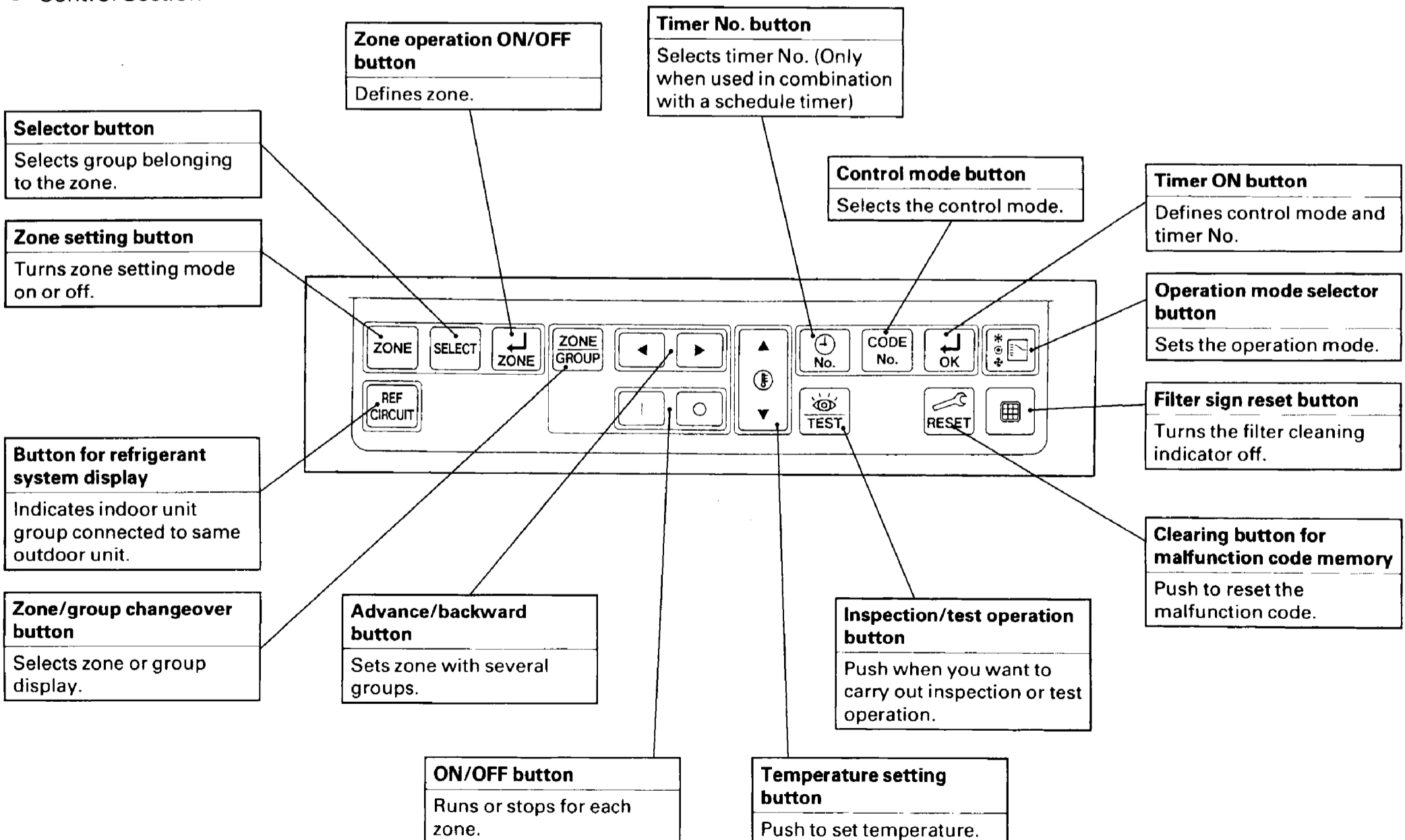

## Control wiring

### Wiring outline

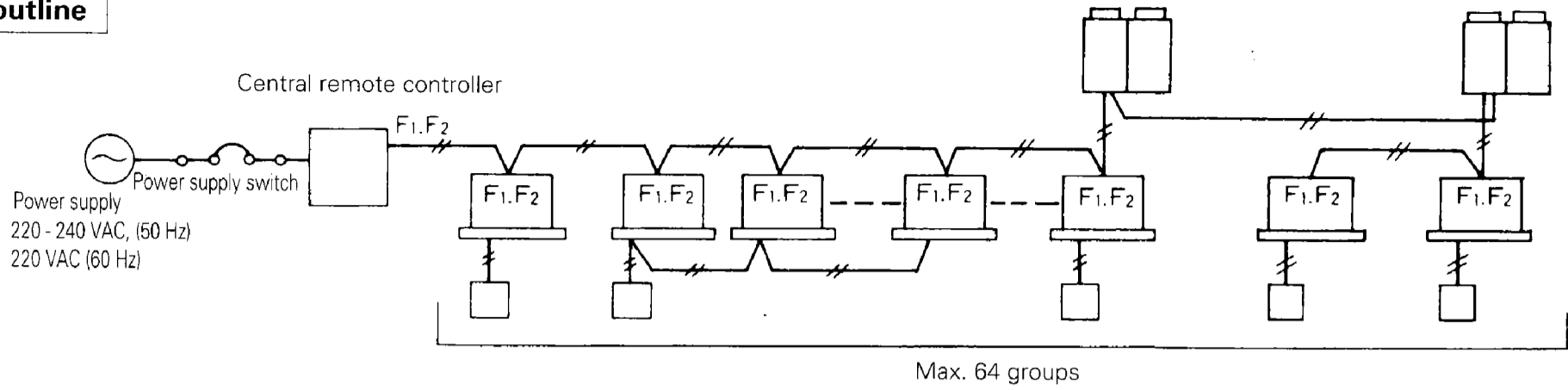

### Wiring specs.

Power supply wiring	2 mm <sup>2</sup>
Transmission wiring for control	0.75 ~ 1.25 mm <sup>2</sup> sheathed vinyl cord or cable (double core); max. extension 1000 m (total wiring length 2000 m)
Power supply switch	10A

### Control wiring connection example (Indoor units in same system shown in the following examples.)

#### (1) series wiring

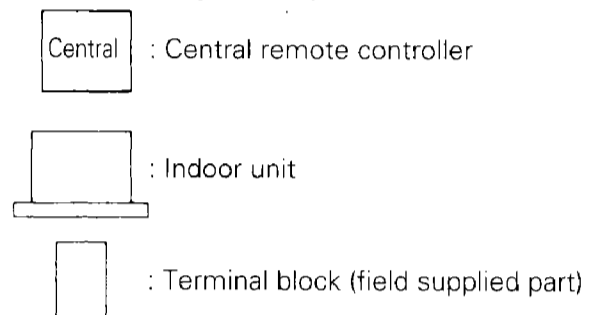
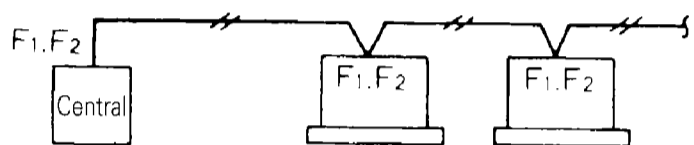

#### (2) Bus wiring (can be branched in max. 16 locations) Example showing 3 branches

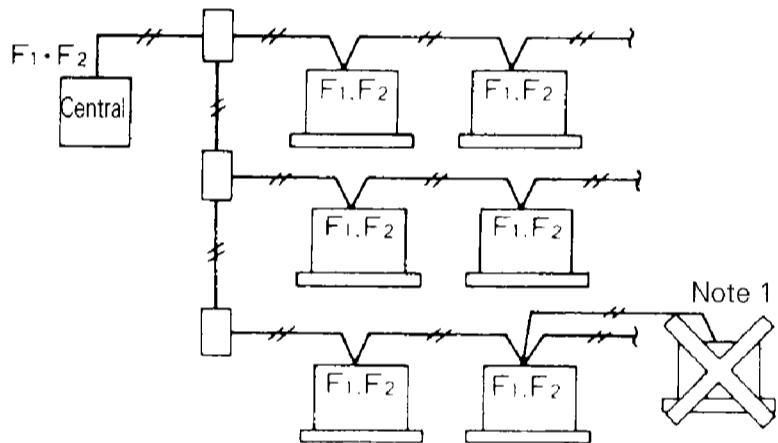

#### (3) Star wiring (can be branched in max. 16 locations) Example showing 3 branches

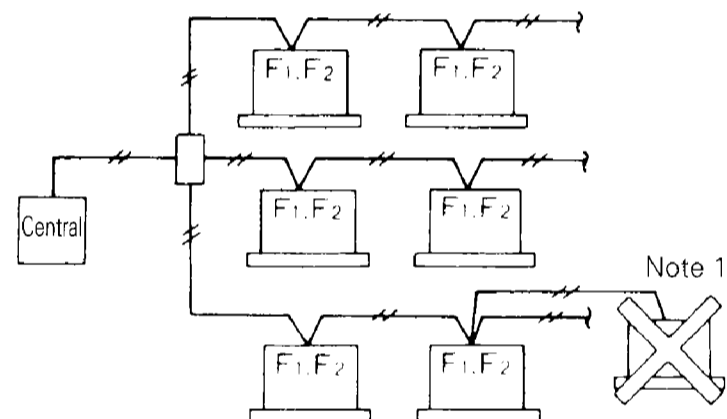

Notes) 1. Cannot be branched again after being branched once.

2. Use a junction terminal block if branching 3 or more control wires from the same terminal block.

3. Do not connect transmission wiring between indoor and outdoor units of different refrigerant circuits.

### Wiring to indoor units

The terminals (F1, F2) of the control terminal block of the central remote controller and the terminals (F1, F2) of indoor units for which a group No. has been set are wired as shown in the figure below. (There is no polarity, so it doesn't matter if F1 and F2 are wired inversely.)

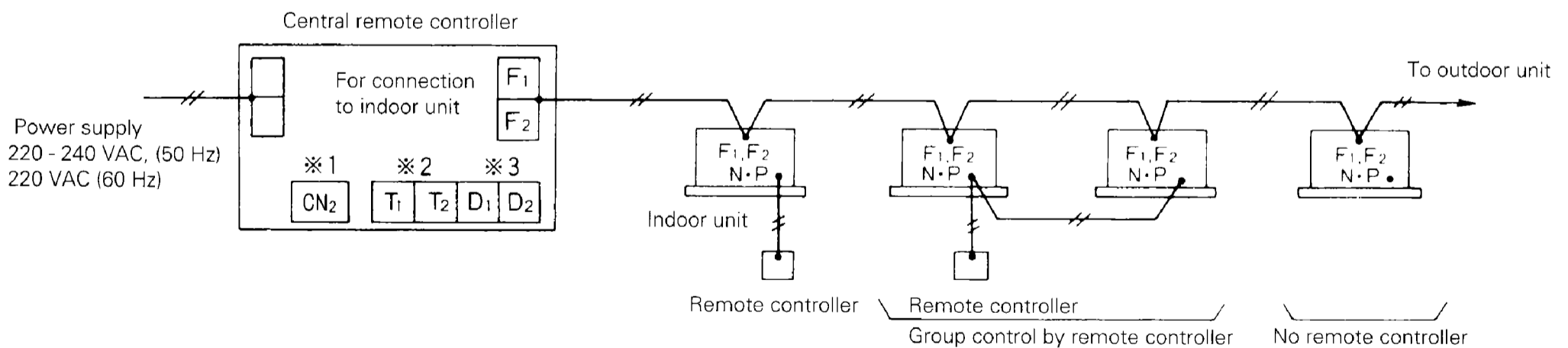

※1. Connector for unification adaptor for computerized control (CN2)

※2. Forced OFF input (T1, T2)

Forced OFF input (no-voltage contact for micro-current) turns off all indoor units while the contact is "closed." Use a contact which guarantees min. applicable load of 16VDC, 10 mA.

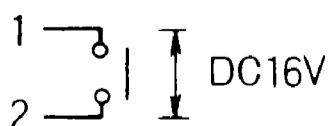

※3. Power supply for schedule timer (D1, D2)



## ■ Contents of control modes

Twenty modes consisting of combinations of the following five operation modes with temperature and operation mode setting by remote controller can be set and displayed by operation modes 0 through 19.

- ON/OFF control impossible by remote controller  
Used when you want to turn on/off by central remote controller only.  
(Cannot be turned on/off by remote controller.)
- OFF control only possible by remote controller  
Used when you want to turn on by central remote controller only, and off by remote controller only.
- Centralized  
Used when you want to turn on by central remote controller only, and turn on/off freely by remote controller during set time.
- Individual  
Used when you want to turn on/off by both central remote controller and remote controller.
- Timer operation possible by remote controller  
Used when you want to turn on/off by remote controller during set time and you do not want to start operation by central remote controller when time of system start is programmed.
- The operation modes are from 0 through 19, however, they can only be set for outdoor units (VRV System inverter K Series) for which cool/heat can be selected by indoor unit. With the exception of this, settings are 0 through 9.

### How to select operation mode

- Whether operation by remote controller will be possible or not for turning on/off, controlling temperature or setting operation mode is selected and decided by the operation mode given on the right edge of the table below.

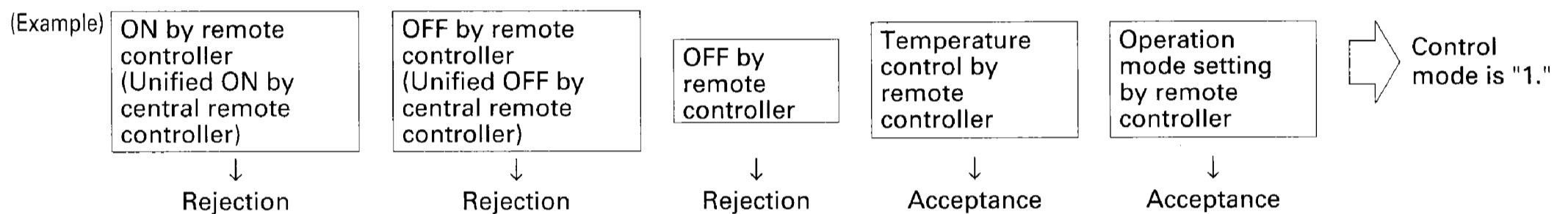

Control mode	Control by remote controller					Control mode	
	Operation		OFF	Temperature control	Operation mode setting		
	Unified operation, individual operation by central remote controller, or operation controlled by timer	Unified OFF, individual stop by central remote controller, or timer stop					
ON/OFF control impossible by remote controller	Rejection (Example)	Rejection (Example)	Rejection (Example)	Rejection	Acceptance	0	
OFF control only possible by remote controller				Acceptance (Example)	Rejection	Acceptance (Example)	1 (Example)
Centralized	Acceptance	Acceptance	Acceptance	Rejection	Acceptance	2	
Individual				Acceptance	Rejection	Acceptance	3
				Acceptance	Rejection	Acceptance	4
Timer operation possible by remote controller				Acceptance (During timer at ON position only)	Acceptance (During timer at ON position only)	Acceptance	Rejection
				Rejection	Rejection	6	
				Acceptance	Acceptance	7	
				Rejection	Rejection	8	
				Acceptance	Acceptance	9	
				Rejection	Rejection	10	
				Acceptance	Acceptance	11	
				Rejection	Acceptance	12	
				Acceptance	Rejection	13	
				Rejection	Acceptance	14	
				Acceptance	Rejection	15	
				Rejection	Acceptance	16	
				Acceptance	Rejection	17	
				Rejection	Acceptance	18	
				Acceptance	Rejection	19	

Do not select "timer operation possible by remote controller" if not using a remote controller. Operation by timer is impossible in this case.

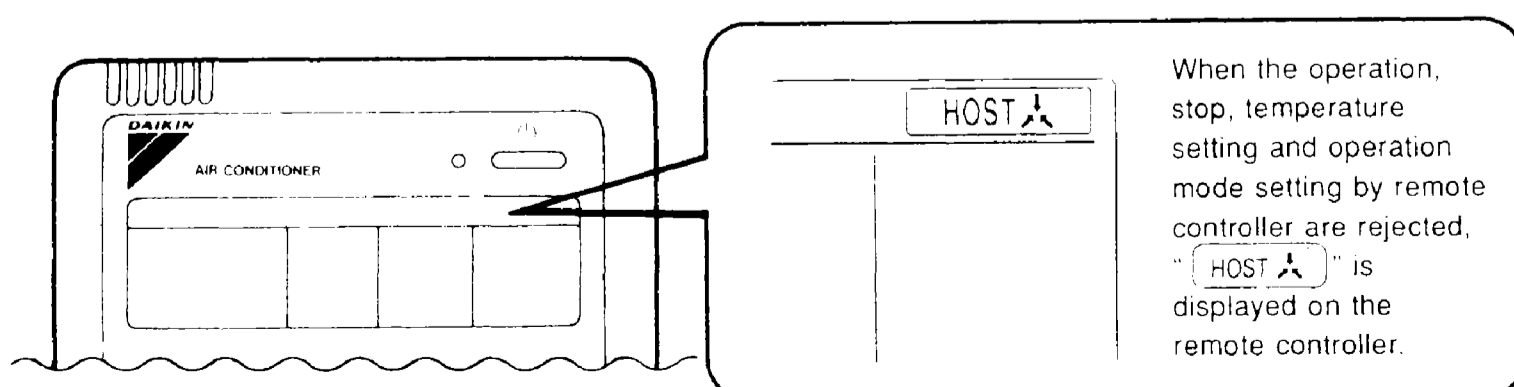

## 20. Unified ON/OFF Controller (DCS301A51/ DCS301B61)

Turns each group of indoor units on/off individually or simultaneously for up to 16 groups (128 units), and lets you check the operation/malfunction display all at once at a glance.

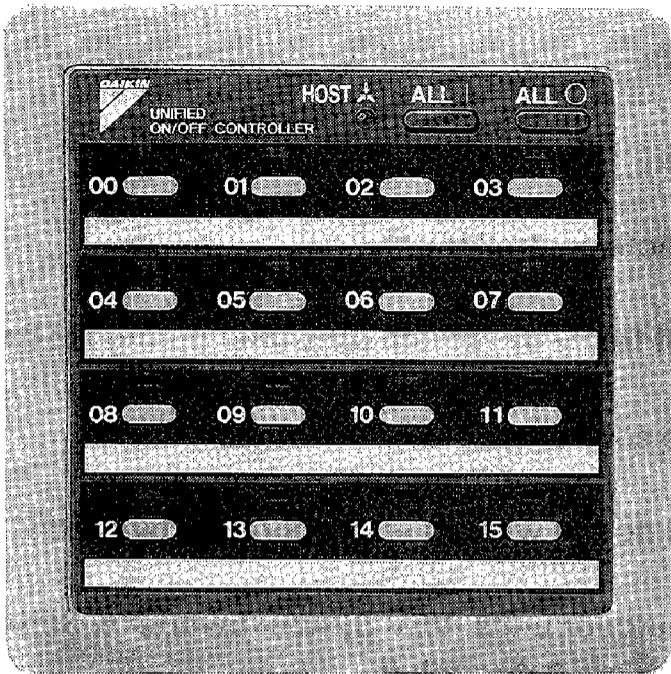

- Lets you turn up to 16 groups of indoor units (128 units) on/off simultaneously or individually, and lets you check the operation/malfunction display all at once at a glance.
- By combining with a central remote controller or schedule timer, you can build a system that matches scale and use .
- Features compact size casing with thickness of only 16 mm. (Uses JIS recessed box for 2)
- Wiring can be extended up to 1 km. For the wiring method, bus type and star type wiring crossover wiring can be used as well as crossover wiring.
- Can be used in combination with other D-BACS equipment.

### ■ System configuration

Up to 16 groups of indoor units can be turned on/off individually or simultaneously by unified ON/OFF controller. Also lets you connect with an outside key system or host computer monitor panel by forced OFF input (no-voltage a contact).

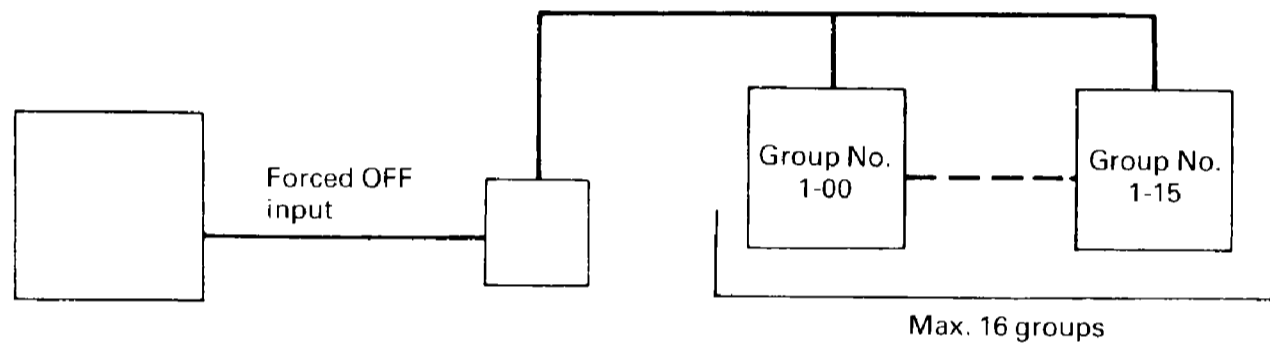

(This optional accessory cannot be used in combination with optional accessory wiring adaptor for electrical appendices.)

A group of indoor units is as described below.

(1) 1 indoor unit with no remote controller



No remote controller

NOTE: If not using remote controllers, use in combination with central remote controller.

(2) 1 indoor unit controlled by either 1 or 2 remote controllers

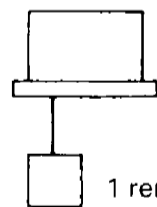

1 remote controller

or

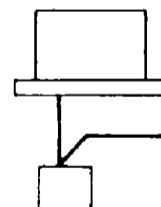

2 remote controllers

(3) Max. 16 indoor units group-controlled by either 1 or 2 remote controllers

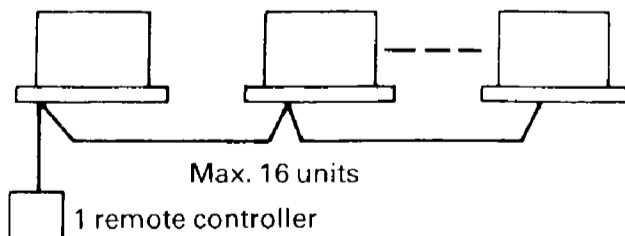

Max. 16 units

1 remote controller

or

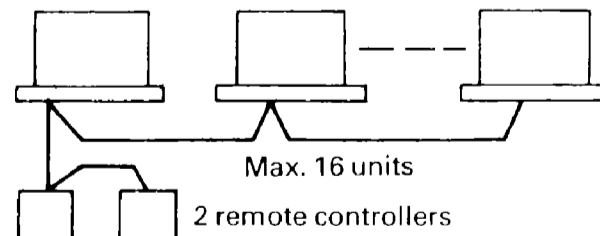

Max. 16 units

2 remote controllers

## ■ Wiring for transmission

### Wiring outline

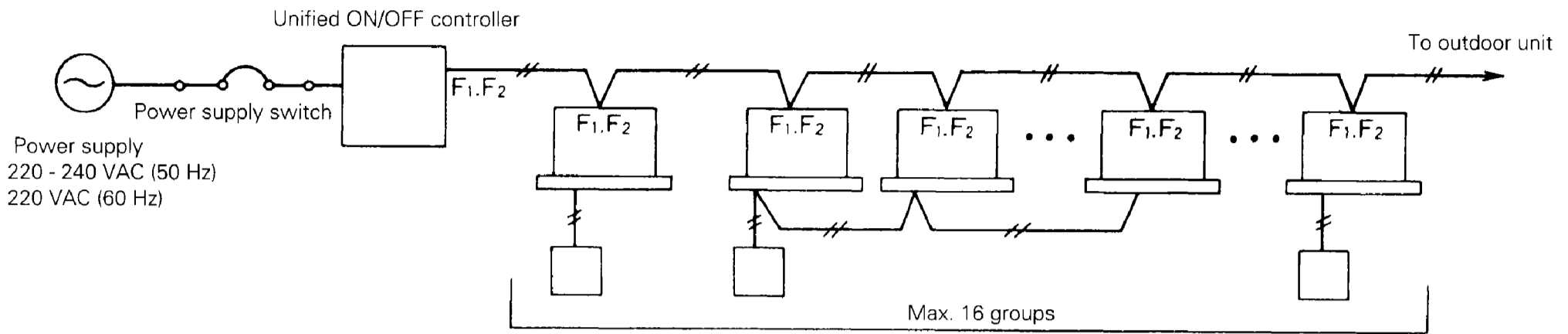

### Wiring specifications

Power supply wiring	2 mm <sup>2</sup>
Wiring for transmission	0.75 ~ 1.25 mm <sup>2</sup> sheathed vinyl cord or cable (double core); max. extension 1000 m (total wiring length 2000 m)
Power supply switch	10A

### Connection example of wiring for transmission

(1)series wiring, (2)bus type wiring and (3)star type wiring are the same as with a central remote controller.

### Wiring for indoor unit

Terminals F1 and F2 of the unified ON/OFF controller's terminal block for control and terminals F1 and F2 of the indoor unit with set group No. are wired as shown in the figure below. (There is no polarity, so it doesn't matter if F1 and F2 are inverted.)

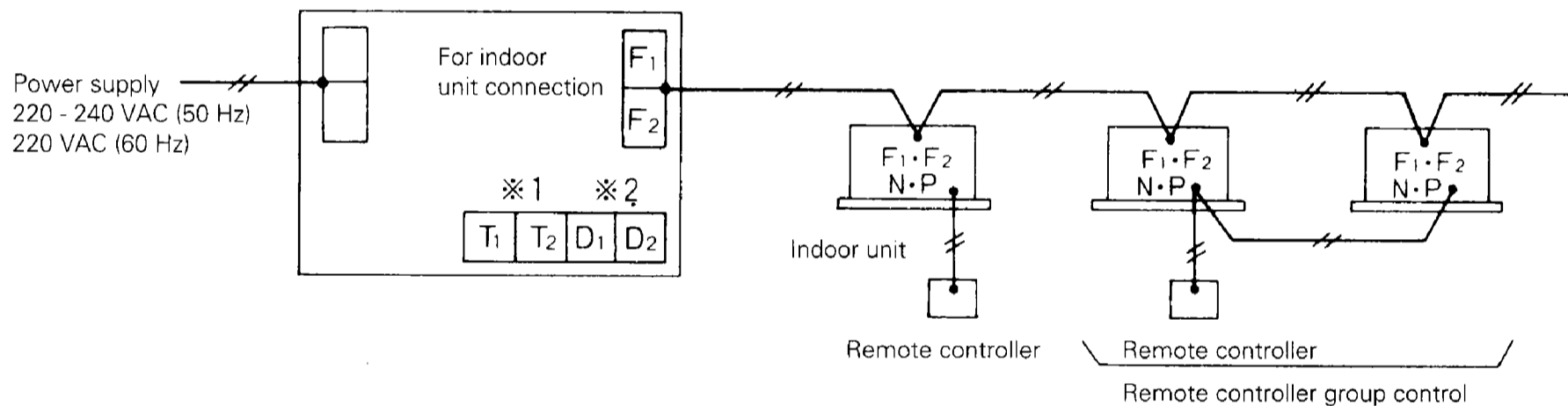

#### ※1: Forced OFF input (T1, T2)

All connected indoor units go off and do not run while forced OFF input (for no-voltage contact, micro-current) is "closed." Use a contact that can guarantee a 16 VDC, 10 mA minimum applicable load.

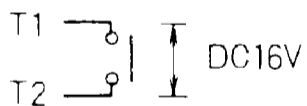

NOTE: If using an instantaneous contactor, use one that handles conducting time of 200 msec or more.

#### ※2: Power supply for schedule timer (D1, D2)

※Wire only if 1, 2 and 3 are used.

## 21. Schedule Timer (DST301A51 / DST301B61)

Allows you to connect and manage by unified control the weekly schedule of up to 128 indoor units.

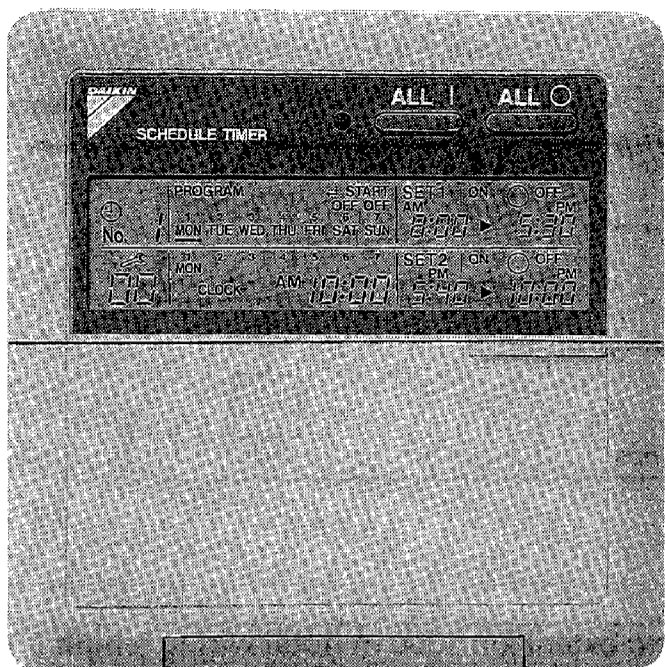

- Manages by unified control the weekly schedule of up to 128 indoor units.
- Lets you set in 1-minute increments on/off time twice a day by the week.
- By combining with a central remote controller or unified ON/OFF controller, you can build a system that matches scale and use.
- When using in combination with a central remote controller, you can set up to eight weekly schedule patterns and distribute among zones by central remote controller as desired.
- Equipped with a power failure compensation function effective for up to 48 hours.
- Features compact size casing with thickness of only 16 mm. (Uses JIS recessed box for 2)
- Wiring can be extended up to 1 km. For the wiring method, bus type and star type wiring crossover wiring can be used as well as crossover wiring.
- Can be used in combination with other D-BACS equipment.

### ■ System configuration and electrical wiring

With a schedule timer, you can program the time units will be turned on/off simultaneously for periods of one week each for up to 16 groups of indoor units.

- System configuration

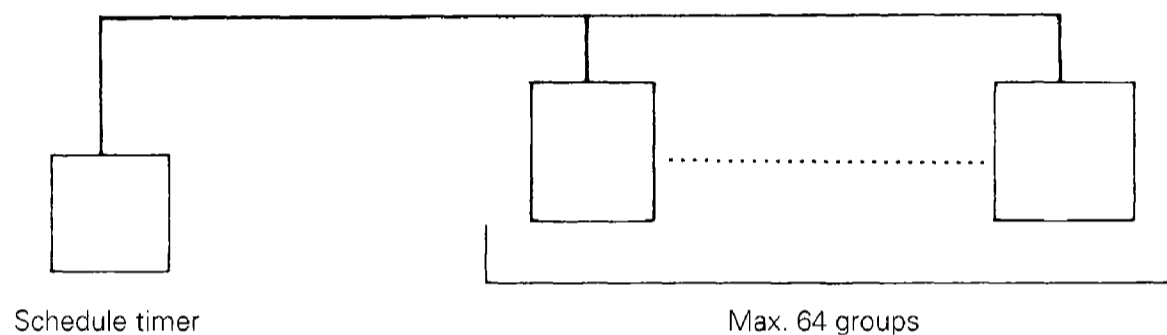

If using the schedule timer individually, you don't have to set the group No. setting for centralized control for group unified control.

- Wiring for transmission

#### Indoor unit wiring

(1) If schedule timer individual use:

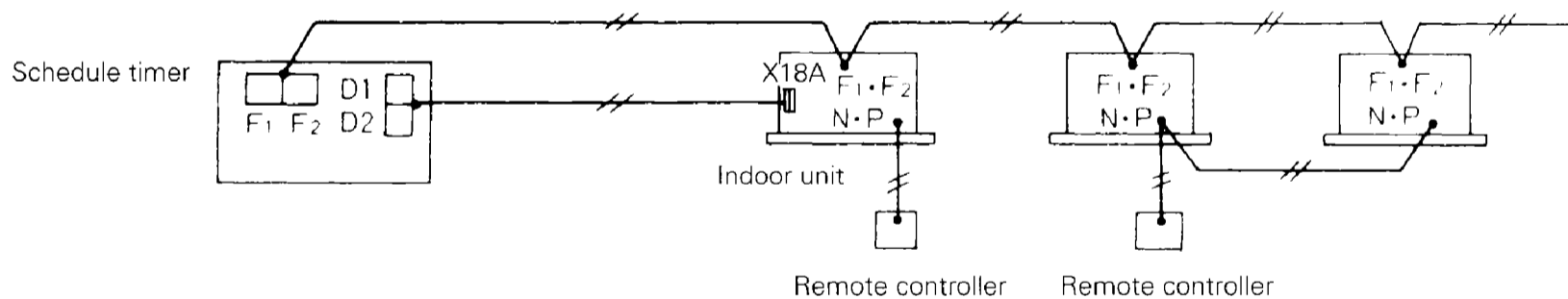

- For the schedule timer's power supply, connect the schedule timer's connectors (D1/D2) and the connector on the indoor unit's PC board (CN18) with the attached cable and crimp style terminals.

(2) If using in combination with other optional controllers for centralized control:

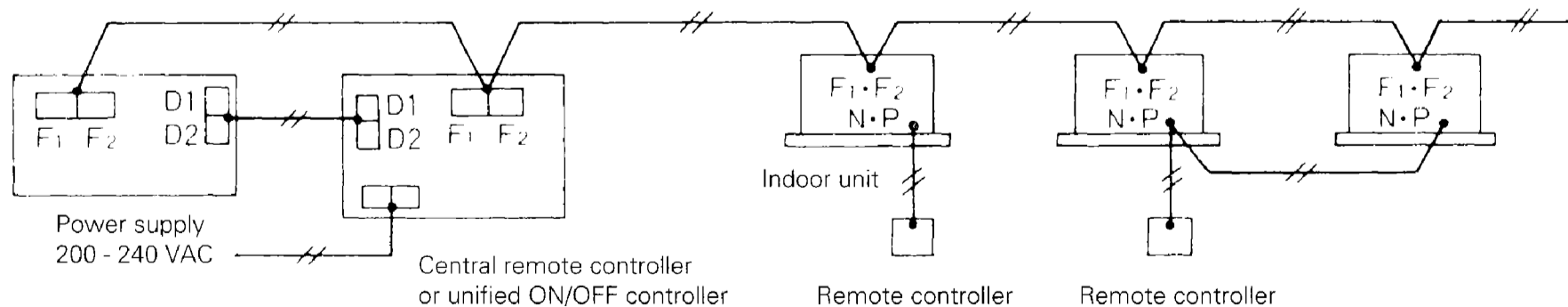

Wiring for transmission: 0.75 ~ 1.25 mm<sup>2</sup> sheathed vinyl cord or cable (double core)...Max. extension 1000 m (Total wiring length 2000 m)

#### Connection example of wiring for transmission

(1) series wiring, (2) bus type wiring and (3) star type wiring are the same as with a central remote controller.

## ■ Schedule timer part names and functions

- Display section (All items in the display are lit for the purpose of explanation, contrary to when actually operating.)

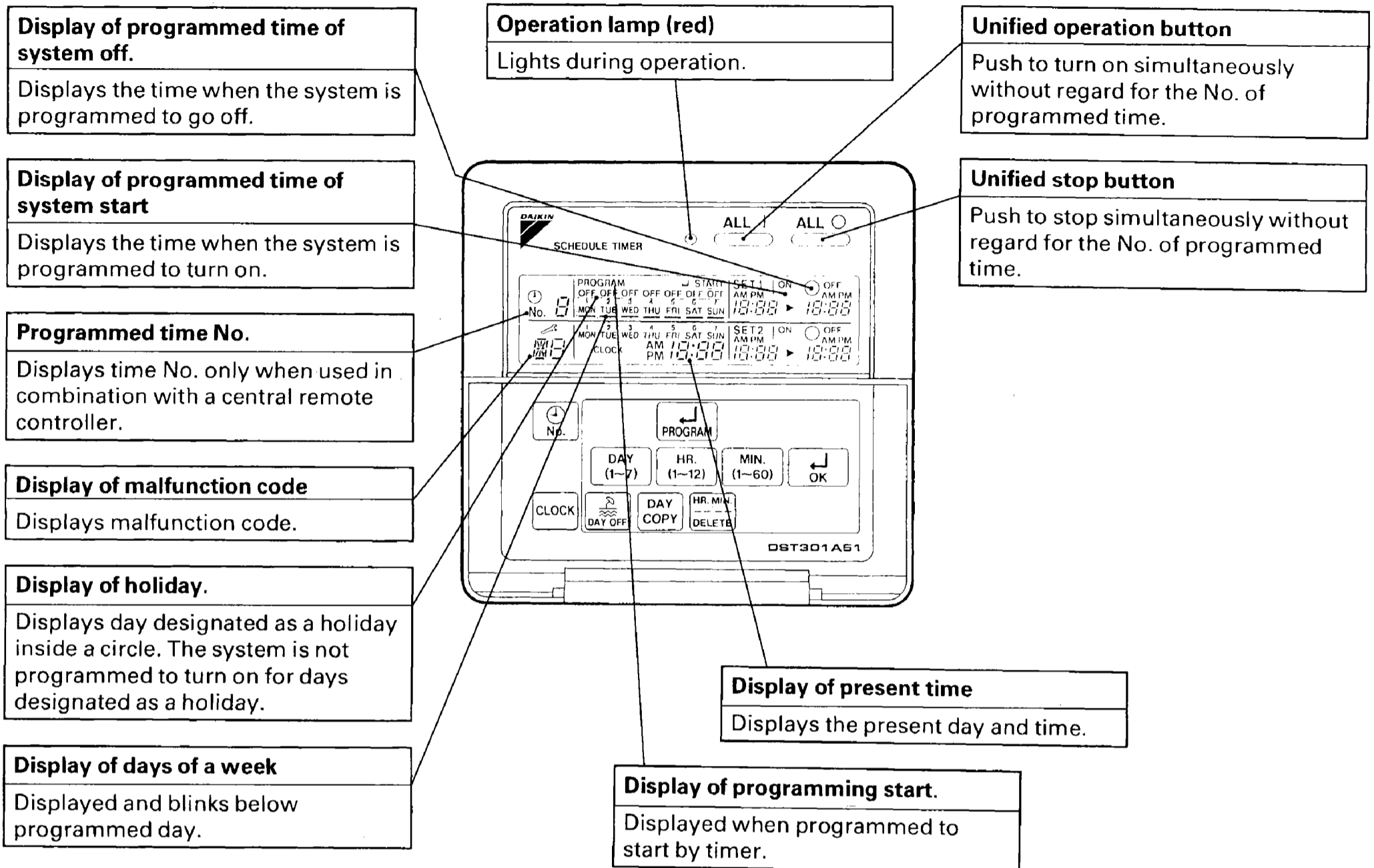

- Control section

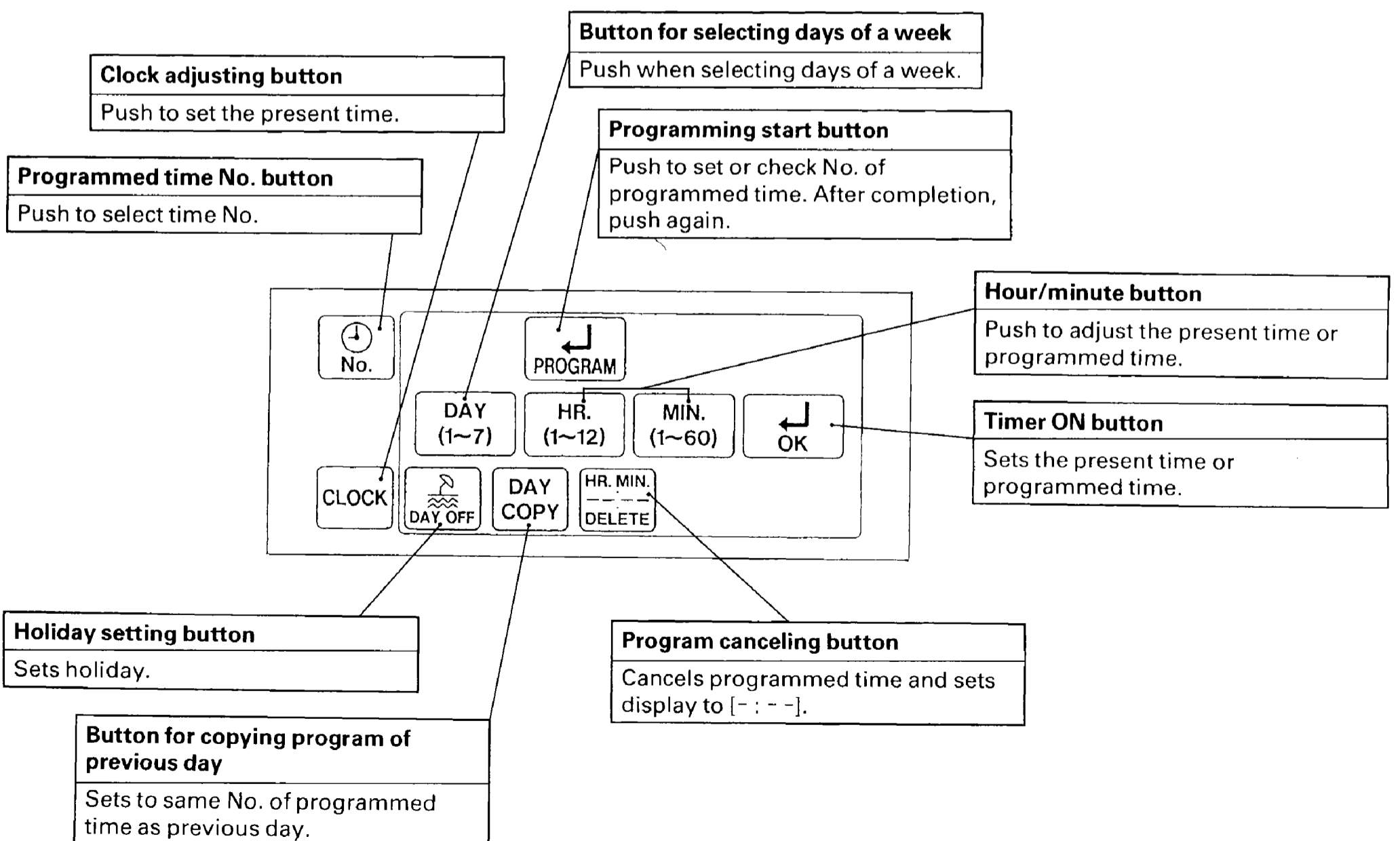

## 22. Combining Different Types of Centralized Control Devices

<DCS302A51 · DCS301A51 · DST301A51>

<DCS302B61 · DCS301B61 · DST301B61>

In addition to using optional controllers for centralized control independently, you also combine and connect a schedule timer and unified ON/OFF controller with a central remote controller. By designing with components, you can construct the best central remote control system for your purpose and scale.

### ■ Example of DCS302A51 / DCS301A51/ DST301A51 Systems

#### ● Unified ON/OFF controller

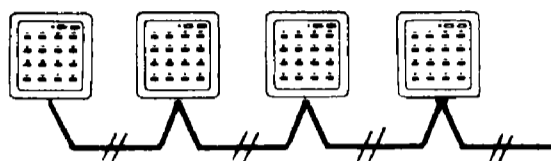

Unified ON/OFF controllers are connected in accordance with the number of indoor units. A single line network can contain up to 16 groups of four units each.

#### ● Schedule timer plus central remote controller

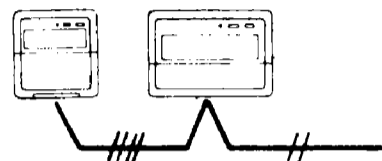

Allows you to set up to eight weekly schedules for turning units ON/OFF twice each day. Enables scheduled operation of up to 64 groups of indoor units individually or by zone.

#### ● Central remote controller plus unified ON/OFF controller

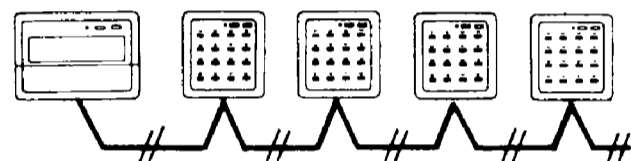

Combines the functionality of a central remote controller with the operability of a unified ON/OFF controller. Enables central control of up to 64 groups of indoor units.

#### ● Schedule timer plus unified ON/OFF controller

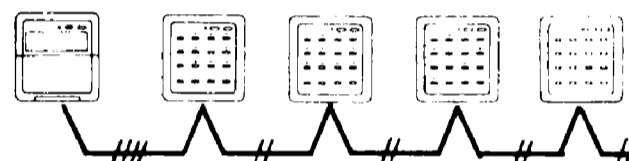

Allows you to set the time for turning units ON/OFF twice each day. Enables unified scheduled operation of up to 64 groups of indoor units.

### ■ Connection for optional controller for centralized control

You can use any combination of one central remote controller, one schedule timer, and from one to four unified ON/OFF controllers. If using the model B Series, you can use any combination of two central remote controller, one schedule timer, and from one to eight unified ON/OFF controllers. The maximum number of units for a single system is 128 for both model A and B.

Central remote controller DCS302A51/B61	Unified ON/OFF remote controller DCS301A51/B61	Schedule timer DST301A51/B61
1	—	—
1	1	—
1	2 ~ 4	—
1	—	1
1	1	1
1	2 ~ 4	1
—	1	—
—	2 ~ 4	—
—	1	1
—	2 ~ 4	1
—	—	1

Central remote controller DCS302B61	Unified ON/OFF remote controller DCS301B61	Schedule timer DST301B61
2	—	—
2	1	—
2	2 ~ 8	—
2	—	1
2	1	1
2	2 ~ 8	1
—	1	—
—	2 ~ 8	—
—	1	1
—	2 ~ 8	1
—	—	1

## Electric wiring

### (Combination of one central remote controller, one schedule timer and three unified ON/OFF controllers)

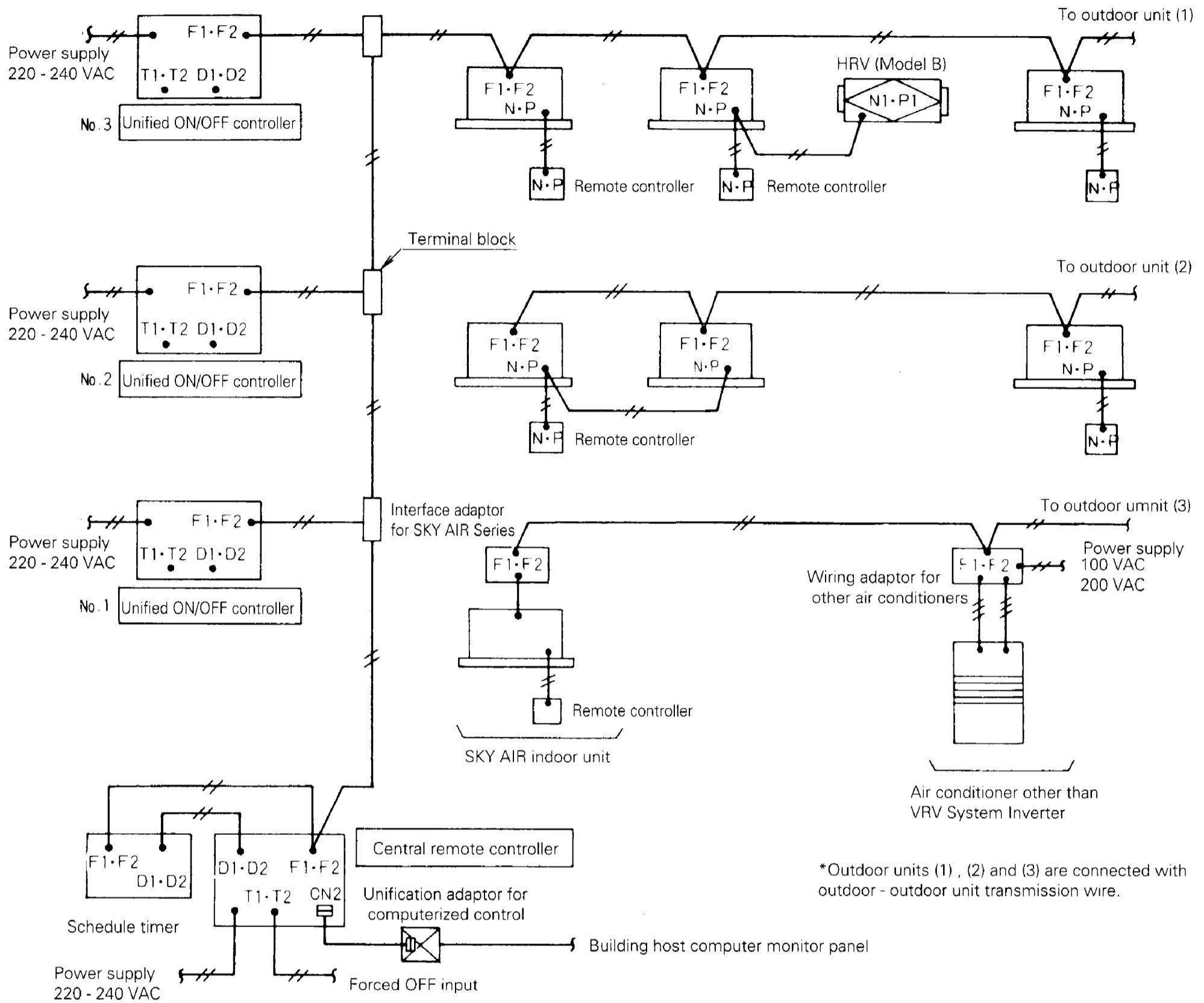

\*Outdoor units (1), (2) and (3) are connected with outdoor - outdoor unit transmission wire.

#### Initial settings of optional controllers for centralized control

##### (1) Central remote controller

- Leave the connector for setting master controller (CN) connected. (Connected at factory set.)  
Connect this connector to one central control line only.
- Control mode  
Sets priority sequence for control of central remote controller and indoor unit remote controllers.
- Zone setting  
Sets zone for controlling several groups within the same zone.

##### (2) Unified ON/OFF controller (No. 1, No. 2, No. 3 in figure above)

- Disconnect the connector for setting master controller (×1A).
- Switch for setting each address (DS1)  
Sets the group No. address for each group of indoor units controlled by unified ON/OFF controller No. 1, No. 2 and No. 3 in the figure above. You can set 16 units (16 groups) for one unified ON/OFF controller.
- Control mode switch (DS2)  
Sets priority sequence for control of central remote controller and indoor unit remote controllers. If used together with a central remote controller, however, the central remote controller's control mode has priority.

##### (3) Schedule timer

- Leave the connector for setting master controller (×1A) disconnected. (Factory set)
- Control mode switch (SS2)  
Sets priority sequence for control of schedule timer and indoor unit remote controllers. If used together with a central remote controller, however, the central remote controller's control mode has priority.

#### Group No. setting centralized control

##### (1) Set by indoor unit remote controller

- Sets group No. by remote controller in the field set mode. (Group No. are 1 - 00 ~ 1 - 15, 2 - 00 ~ 2 - 15, .....4 - 00 ~ 4 - 15.....)

##### (2) Setting by PC board adaptor

- If using an interface adaptor for SKY AIR Series or wiring adaptor for other air conditioners, set the centralized control group No. with group No. setting switches RS1 and RS2 on the PC board.  
1 ~ 4 for RS1 (upper)  
(1 ~ 8 for interface adaptor for SKY AIR Series)  
0 ~ F for RS2 (lower)

**MEMO**



# **TROUBLESHOOTING**

## **Inverter K Series**

# 1. Operation Flowcharts

The following flowcharts illustrate:

1. Indoor unit : Operation flow of a single indoor unit
2. Outdoor unit : Operation flow of a single outdoor unit connected to more than one indoor units in a single system

## Indoor unit operation flowchart

### ■ Operation flowchart

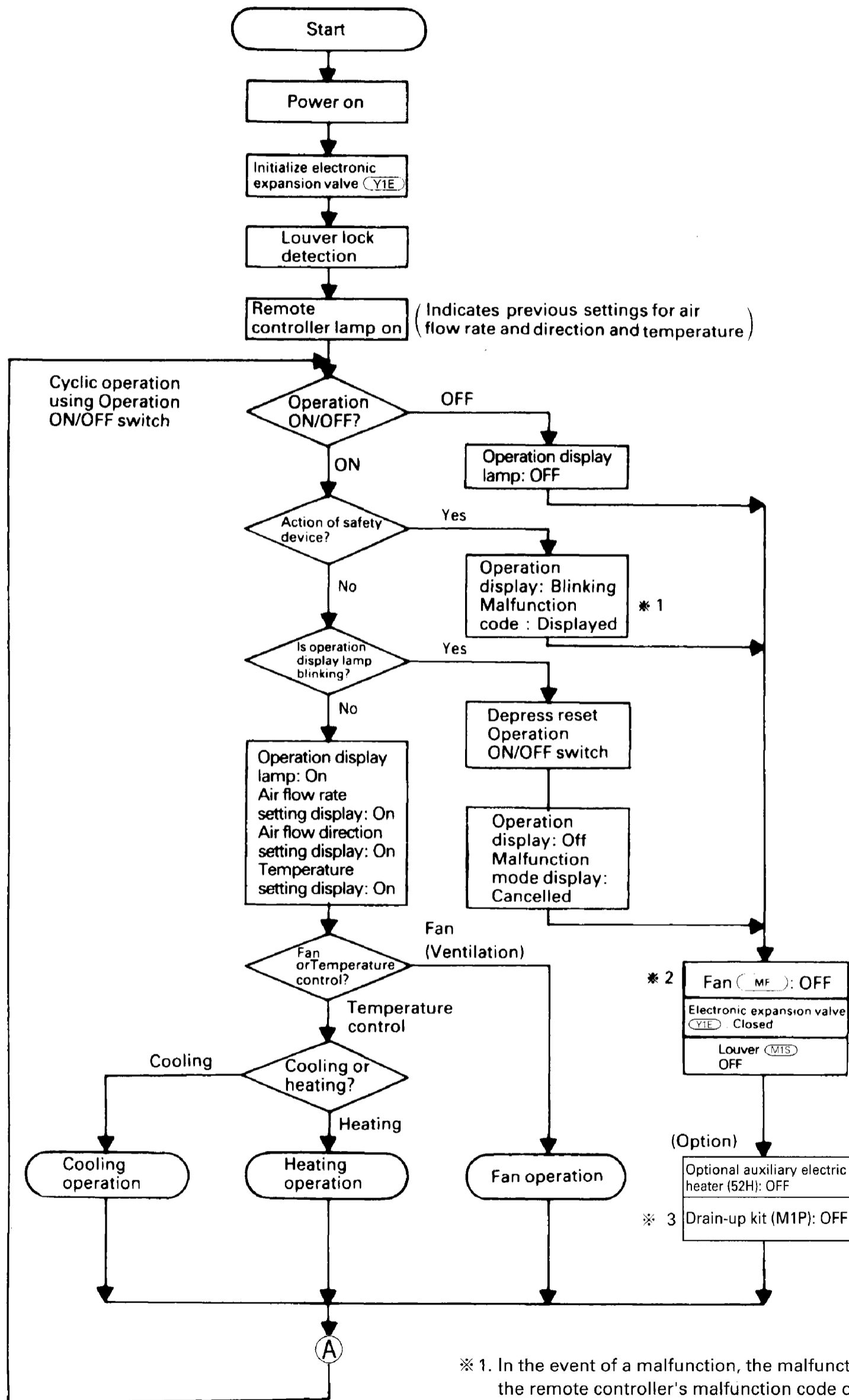

- \* 1. In the event of a malfunction, the malfunction code is displayed in the remote controller's malfunction code display.
- \* 2. When the auxiliary electric heater is on, the fan stops after one minute residual operation.
- \* 3. When the drain-up kit is ON, it stops after five minutes residual operation.

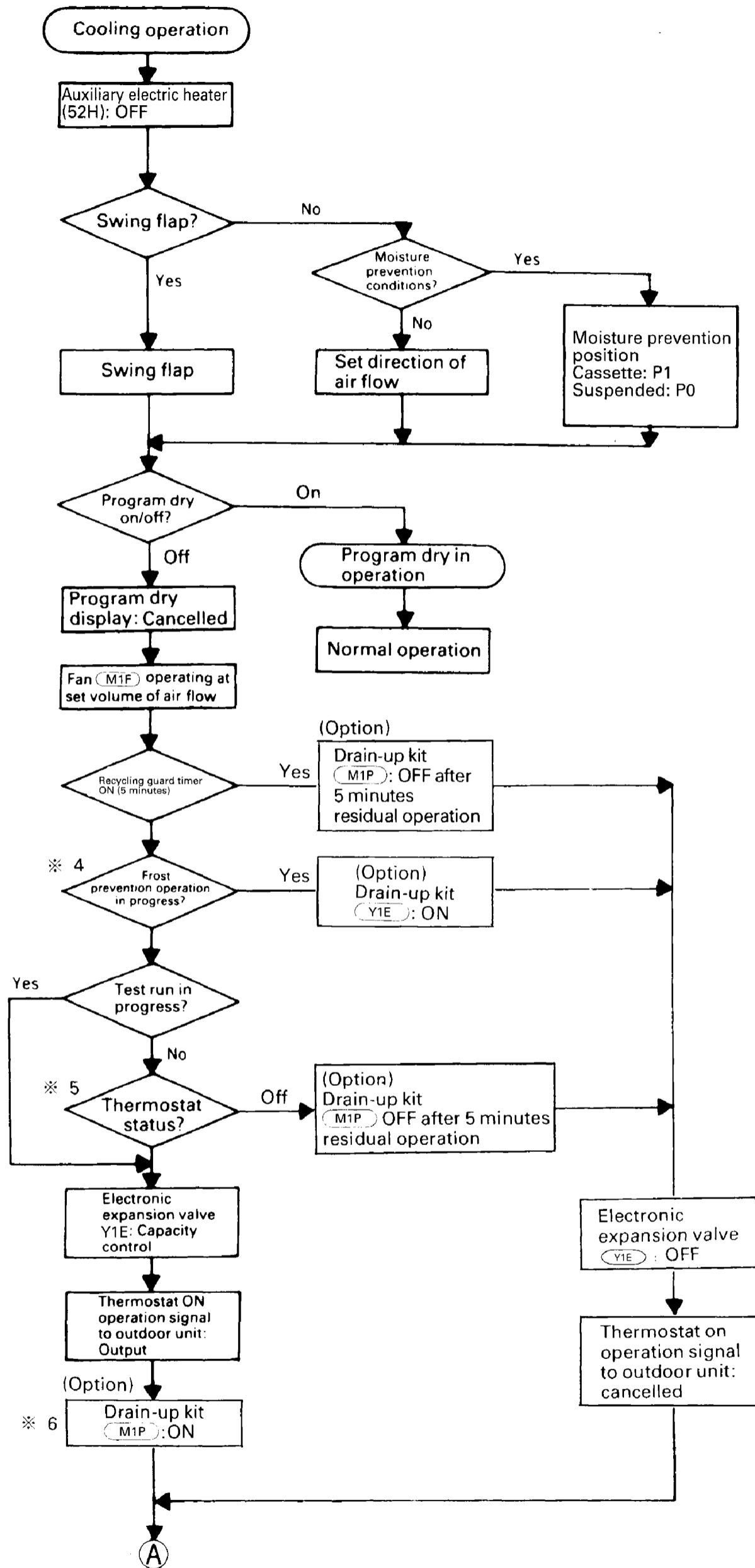

※ 4. If the evaporator inlet temperature is  $-5^{\circ}\text{C}$  or lower, or is  $-1$  or lower for a total of 40 minutes, frost prevention operation is initiated. Normal operation resumes when the temperature is  $+7^{\circ}\text{C}$  or higher for 10 consecutive minutes.

※ 5. Thermostat status

※ 6. The drain-up kit is standard equipment for models FXYC - H, FXYF, FXYK and FXYH

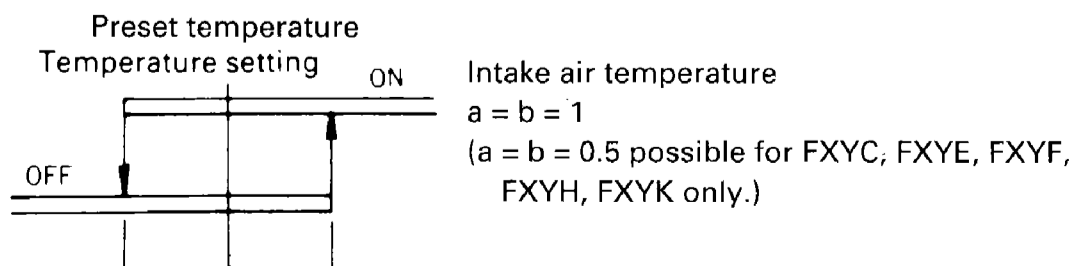

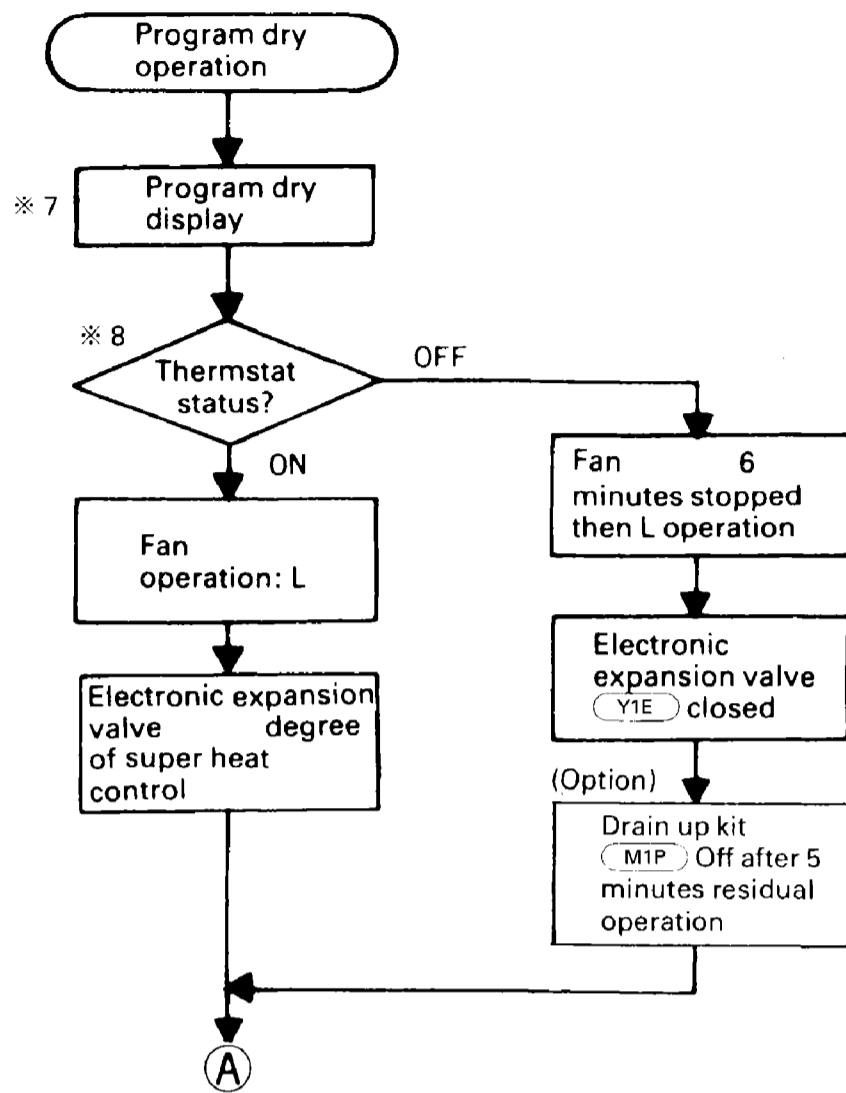

- ※ 7. Programmed dry display  
Does not display preset temperature and air flow settings of the controller.
- ※ 8. Thermostat status  
Preset temperature during programmed dry operation

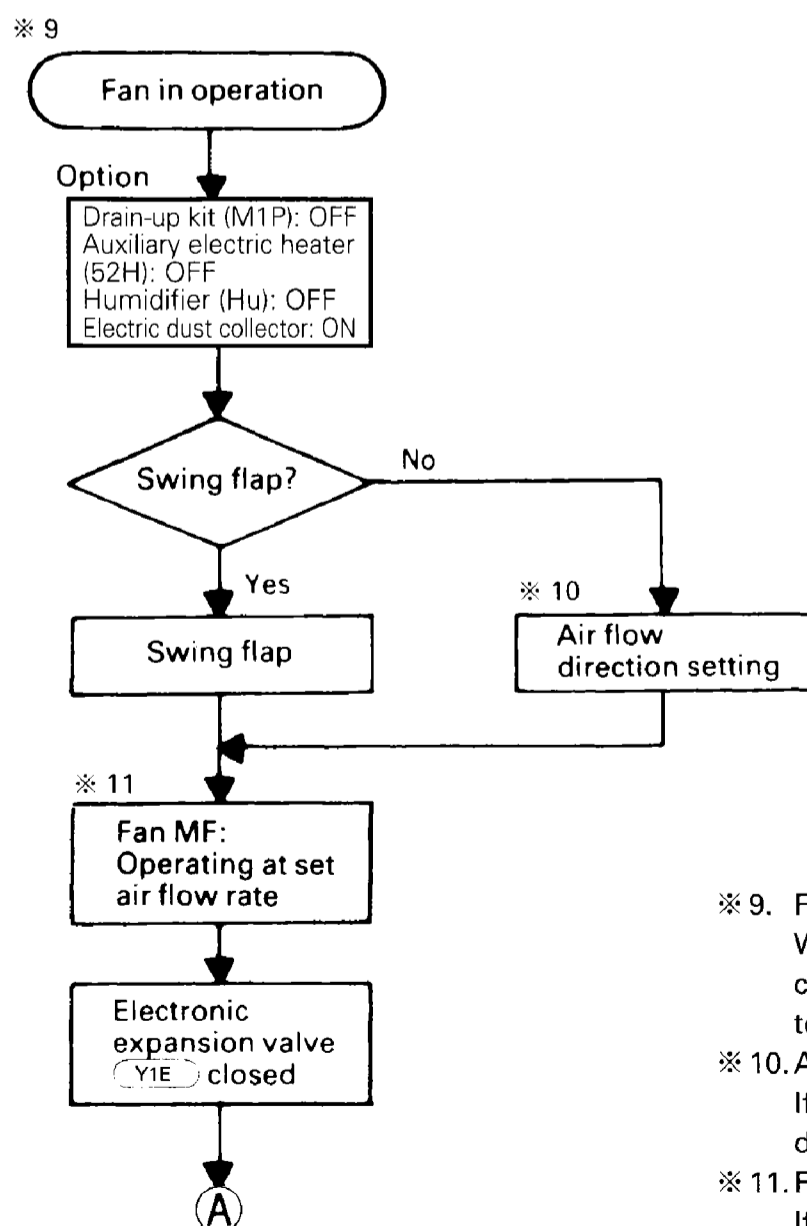
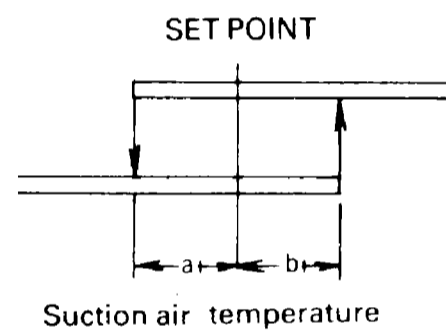

- ※ 9. Fan operation  
When fan operation has been selected using the remote controller, operation is turned OFF by thermostat when temperature control operation has been selected.
- ※ 10. Air flow direction setting  
If fan operation is selected with the remote controller, air discharge is 100% horizontal during heating.
- ※ 11. Fan  
If fan operation is selected with the remote controller, LL speed operation is carried out during heating.

Heating operation

Drain-up kit (M1P): Off

Swing flap?

No

Yes

Swing flap

※ 12

Air flow direction setting

※ 12

Defrost operation in progress?

Yes

No

Hot start in progress?

※ 13

Yes

No

Defrost / Hot start display: Off

Defrost / Hot start display: On

Yes

Recycling guard timer ON (5 minutes)?

No

Test run in progress?

Thermostat status?

③

①

②

Option

Auxiliary electric heater (52H): OFF  
Humidifier (Hu): OFF

Option

Auxiliary electric heater (52H): OFF  
Humidifier (Hu): ON

Option

Auxiliary electric heater (52H): ON  
Humidifier (Hu): ON

Option

Auxiliary electric heater (52H): OFF  
Humidifier (Hu): OFF

※ 15

Under the protection for low discharge air temperature

Yes

No

Fan (M1F): LL operation

Fan (M1F): Operating at set air flow volume

Fan (M1F): L operation

Fan (M1F): Off

Electronic expansion valve (Y1E) closed

Electronic expansion valve (Y1E) capacity control

Electronic expansion valve (Y1E) open

A

※ 12. Air flow direction

Air discharge is 100% horizontal when heating operation is turned off by thermostat.

※ 13. Hot start

Hot start is carried out when operation starts or defrosting is complete, and condenser inlet temperature exceeds 34°C, or 3 minutes elapses, or when Tc > 52°C.

※ 14. Thermostat status

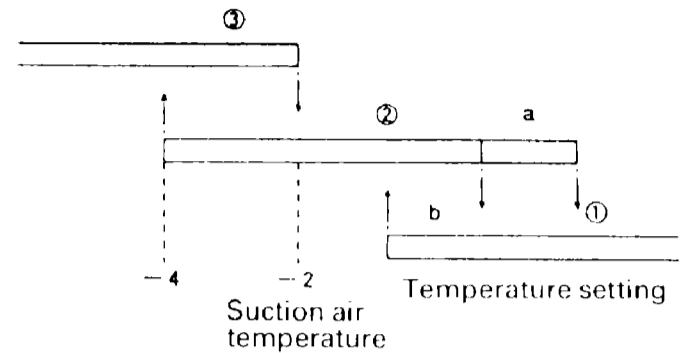

※ 15. Low discharge air temperature protection

Protection is effected when the preset temperature is 24°C or lower and the opening of the electronic expansion valve is slight

# Outdoor unit operation flowchart

## ■ Operation flowchart

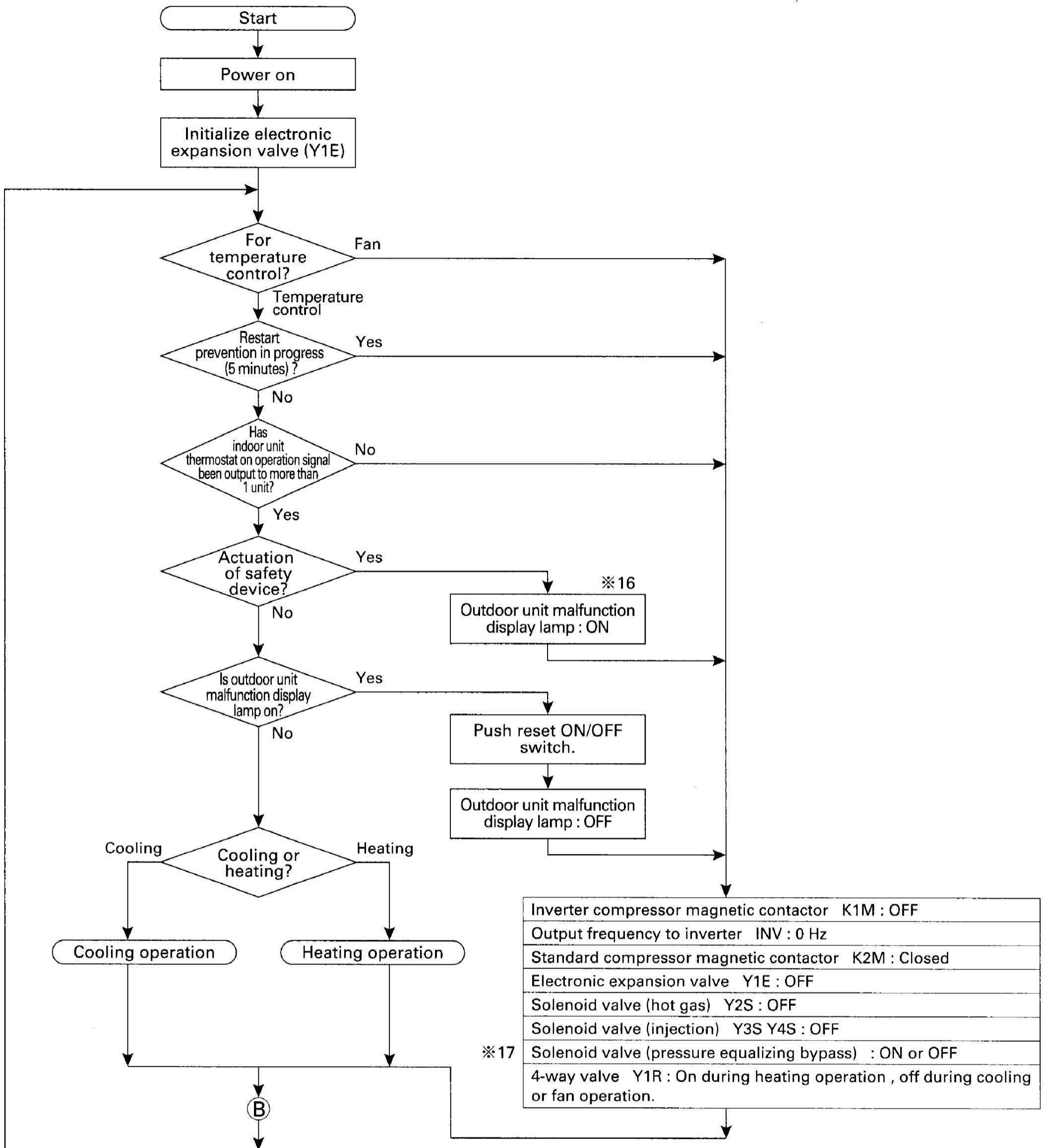

※ 16 If the outdoor unit malfunction display lamp is on then this either indicates that the outdoor unit operation has been terminated abnormally or warns that there is refrigerant shortage or else that there is a piping or wiring fault (operations will continue). (Refer to Indoor Unit Control ※1)

※ 17 ON operations restart 4 minutes after the inverter compressor has stopped.

Note: The crank case heaters (CH) are on when the magnetic relays of their respective compressors are off.

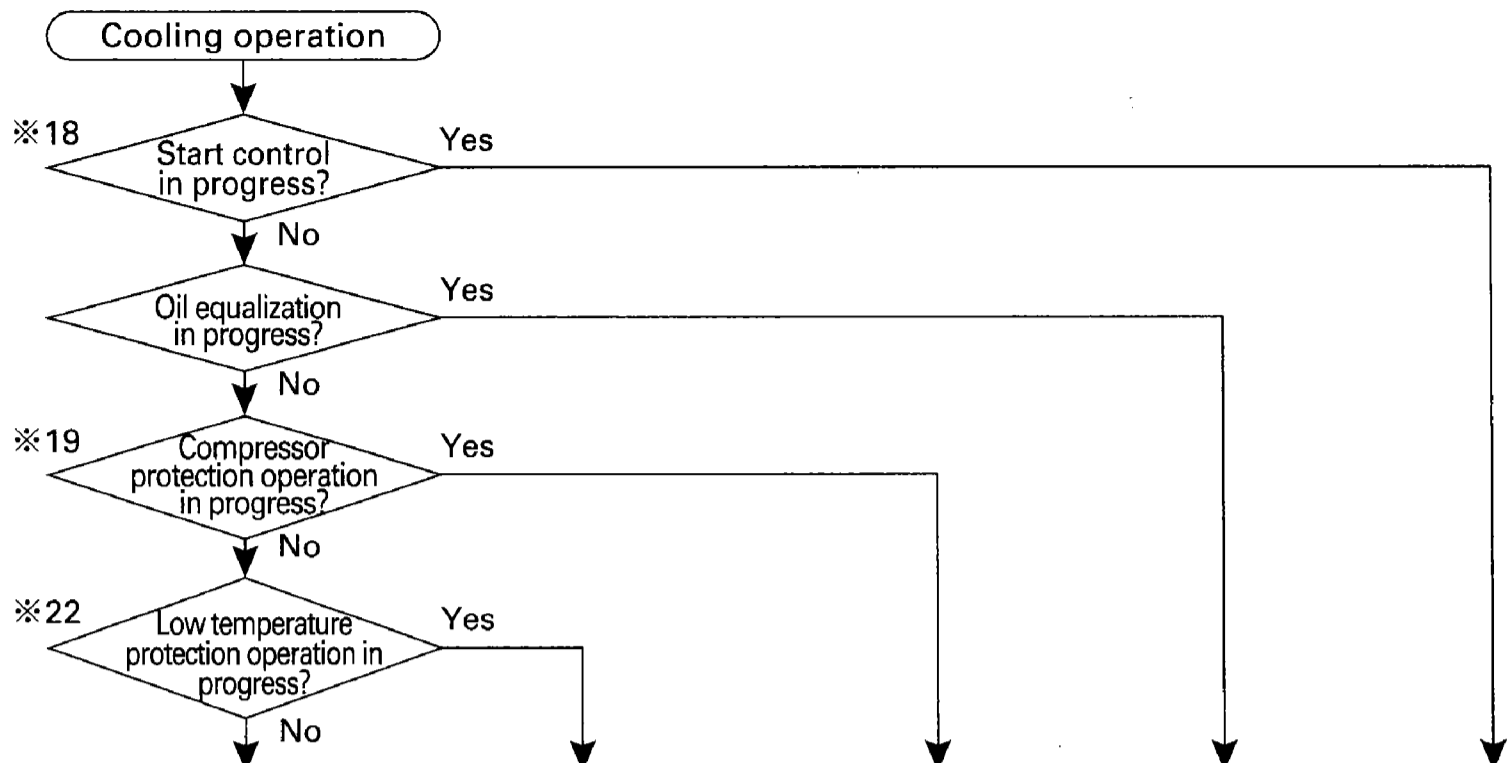

Inverter compressor magnetic contactor	K1M	ON				
Inverter output frequency	INV	30~116 Hz by P1 control ※20	30~116 Hz	30~116 Hz by P1 and protective control	38 Hz	42 Hz
Standard compressor magnetic contactor	K2M	ON/OFF by P1 control	OFF	ON/OFF by P1 and protective control	ON	OFF
Electronic expansion valve	Y1E	Open				
Solenoid valve (hot gas)	Y2S	OFF	ON/OFF by saturation temperature corresponding to suction pressure	OFF	ON	ON
※21 Solenoid valve (injection)	Y3S Y4S	ON/OFF by discharge temperature protection control				ON
4-way valve	Y1R	OFF				
Fan	M1F	H	※22	H		
Fan	M2F	ON		ON		

ⓑ

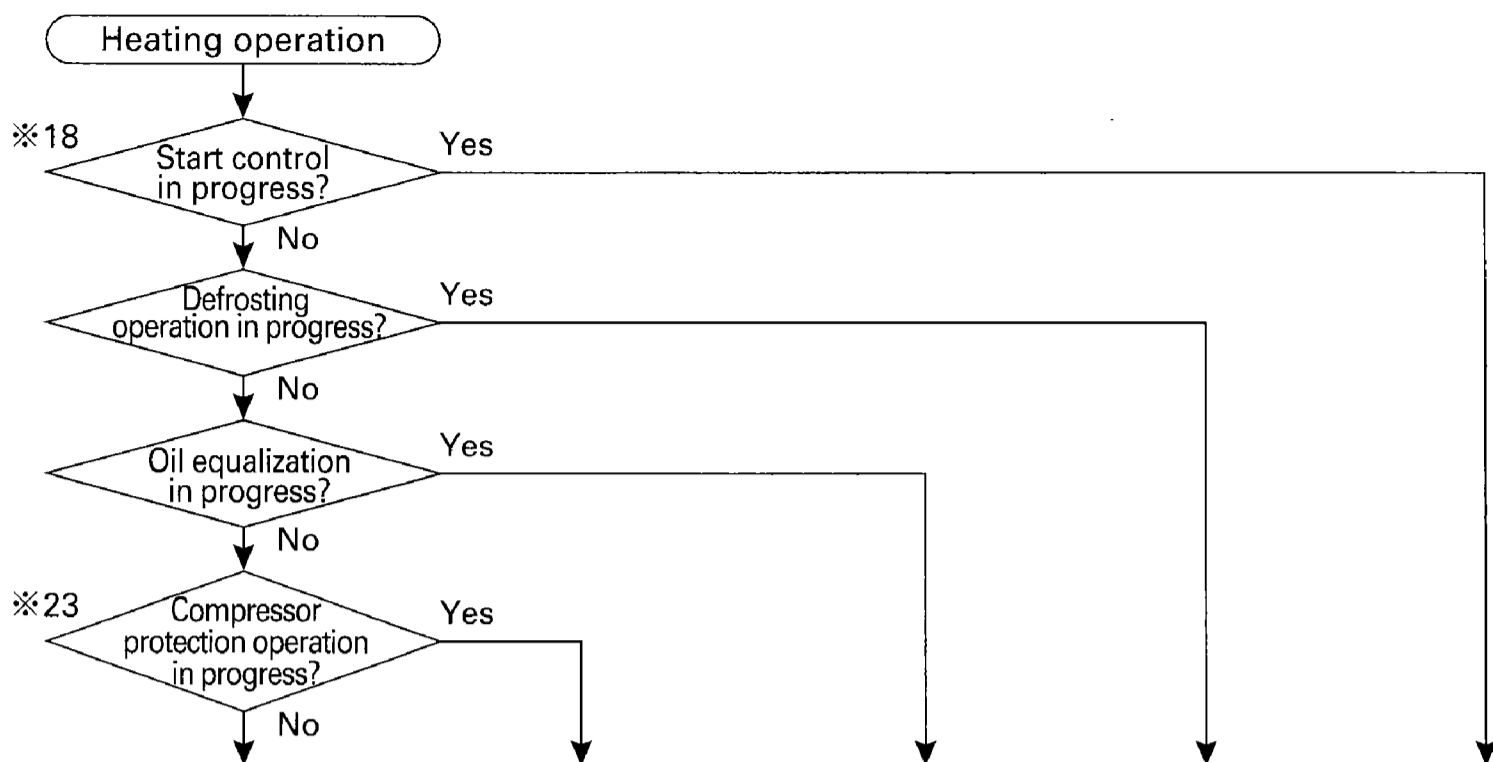

Inverter compressor magnetic contactor K1M	ON				
Inverter output frequency INV	30~116 Hz by P1 control ※24	30~116 Hz by P1 and protective control	38 Hz	86 Hz	42 Hz
Standard compressor magnetic contactor K2M	ON/OFF by P1 control	ON/OFF by P1 and protective control	ON	ON	OFF
Electronic expansion valve Y1E	Flow rate control			Open	Flow rate control
Solenoid valve (hot gas) Y2S	OFF	ON/OFF by saturation temperature corresponding to suction pressure	OFF	ON	
※21 Solenoid valve (injection) Y3S Y4S	ON/OFF by discharge temperature protection control				
4-way valve Y1R	ON		OFF		ON
Fan M1F	H		OFF		H
Fan M2F	ON		OFF		ON

ⓑ

※18. Start control

60 second start control in order to prevent liquid back to the compressor.

※19. Compressor protection

1. Protection control is triggered when the cooling load is large and the saturation temperature corresponding to suction pressure is high.
2. Protection control is triggered when secondary inverter current exceeds set current.
3. Protection control is triggered by discharge temperature.
4. Protection control is triggered when saturation temperature corresponding to suction pressure is low.

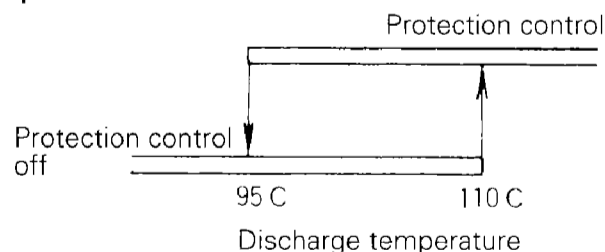

※23. Compressor protection

1. Protection control is triggered when secondary inverter current exceeds set current.
2. Protection control is triggered by discharge temperature.

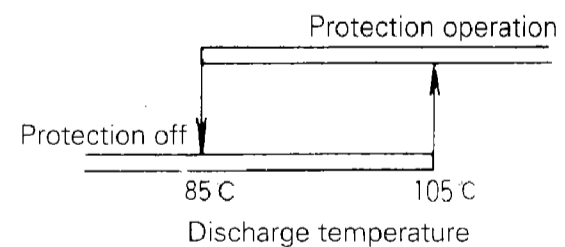

3. Protection control is triggered when the heating load is small and the saturation temperature corresponding to suction pressure is high.
4. Protection control is triggered when saturation temperature corresponding to suction pressure is low.

※24. P1 control

Controls ON/OFF of the standard compressor and inverter output frequency so that discharge pressure is the optimal value.

※20. P1 control

Controls ON/OFF of the standard compressor and inverter output frequency so that suction pressure is the optimal value.

※21. Discharge temperature protection

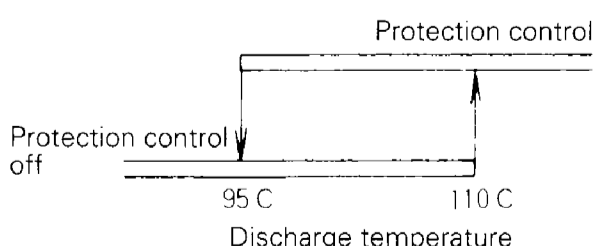

※22. Fan control during low temperature protection

If Tc is less than 26.1°C for 30 continuous seconds, fan speed changes as follows: H + ON → H + OFF → L + OFF. When Tc becomes greater than 52.4°C, fan speed returns to H + ON.



## 2 Diagnosis by Malfunction Code

Malfunction code	Malfunction contents	Fan operation	Page
A0	Indoor unit: Error of external protection device		95
A1	Indoor unit: PC board defect		95
A3	Indoor unit: Malfunction of drain level control system (33H)	○	96
A6	Indoor unit: Fan motor (M1F) lock, overload		97
A7	Indoor unit: Malfunction of swing flap motor (M1S)	○	98
A9	Indoor unit: Malfunction of moving part of electronic expansion valve (Y1E)	○	99
AF	Indoor unit: Drain level above limit		100
AJ	Indoor unit: Malfunction of capacity determination device		101
C4	Indoor unit: Malfunction of thermistor (R2T) for liquid pipe	○	102
C5	Indoor unit: Malfunction of thermistor (R3T) for gas pipes	○	102
C9	Indoor unit: Malfunction of thermistor (R1T) for air inlet	○	103
CJ	Indoor unit: Malfunction of thermostat sensor in remote controller	○	103
E0	Outdoor unit: Actuation of safety device		104
E1	Outdoor unit: PC board defect		105
E3	Outdoor unit: Actuation of high pressure switch		105
E4	Outdoor unit: Actuation of low pressure switch	○	106
E9	Outdoor unit: Malfunction of moving part of electronic expansion valve (Y1E)	○	107
F3	Outdoor unit: Abnormal discharge pipe temperature	○	108
H9	Outdoor unit: Malfunction of thermistor for outdoor air (R1T)	○	109
J3	Outdoor unit: Malfunction of discharge pipe thermistor (R3T)	○	109
J5	Outdoor unit: Malfunction of thermistor (R4T) for suction pipe	○	110
J6	Outdoor unit: Malfunction of thermistor (R2T) for heat exchanger	○	110
JA	Outdoor unit: Malfunction of discharge pipe pressure sensor	○	111
JC	Outdoor unit: Malfunction of suction pipe pressure sensor	○	112
JH	Outdoor unit: Malfunction of oil temperature thermistor (R5T)	○	113
U0	Low pressure drop due to refrigerant shortage or electronic expansion valve failure	○	114
U1	Negative phase, open phase	○	115
U2	Power supply insufficient or instantaneous failure	○	131
U4	Malfunction of transmission between indoor units	○	116
U5	Malfunction of transmission between remote controller and indoor unit		117
U7	Malfunction of transmission between outdoor units	○	118
U8	Malfunction of transmission between master and slave remote controllers	○	119
U9	Malfunction of transmission between indoor and outdoor units in the same system	○	120
UA	Excessive number of indoor units	○	121
UC	Address duplication of central remote controller	○	121
UF	Refrigerant system not set, incompatible wiring/piping	○	122
UH	Malfunction of system, refrigerant system address undefined	○	123

## Inverter failure diagnosis

Malfunction code	Malfunction contents	Fan operation	Page
L4	Outdoor unit: Malfunction of inverter radiating fin temperature rise	○	126
L5	Outdoor unit: Inverter instantaneous over-current	○	127
L8	Outdoor unit: Inverter thermostat sensor, compressor overload	○	128
L9	Outdoor unit: Inverter stall prevention, compressor lock	○	129
LC	Outdoor unit: Malfunction of transmission between inverter and control PC board	○	130
P1	Outdoor unit: Inverter over-ripple protection	○	132
P4	Outdoor unit: Malfunction of inverter radiating fin temperature rise sensor	○	133

## Failure diagnosis for optional controllers for centralized control

Malfunction code	Optional controllers for centralized control	Malfunction contents	Page
UE	Central remote controller Schedule timer	Malfunction of transmission between central remote controller and indoor unit	134
			138
M1	Central remote controller Schedule timer	PC board defect	135
			139
M8	Central remote controller Schedule timer	Malfunction of transmission between optional controllers for centralized control	135 139
MA	Central remote controller Schedule timer	Improper combination of optional controllers for centralized control	136 140
MC	Central remote controller Schedule timer	Address duplication, improper setting	137
			141
—	Unified ON/OFF controller	Operation lamp blinks	142
		Display "under host computer integrate control" blinks (repeats single blink)	143
		Display "under host computer integrate control" blinks (repeats double blink)	145

### 3. Failure Diagnosis

#### Remote controller display

#### Malfunction code "A0" blinks.

#### Cause of malfunction

- (1) Actuation of external protection device
- (2) Improper field set
- (3) Defect of indoor unit PC board

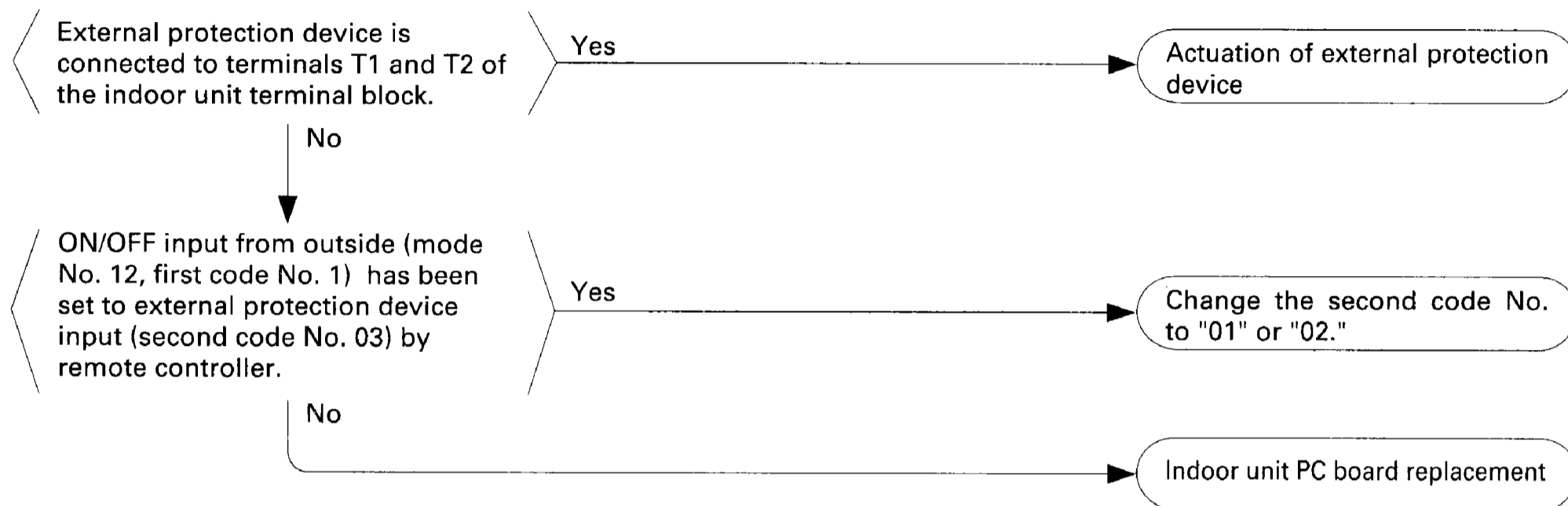

#### Remote controller display

#### Malfunction code "A1" blinks.

#### Cause of malfunction

- (1) Defect of indoor unit PC board

Replace the indoor unit PC board.

## Remote controller display

### Malfunction code "A3" blinks.

#### Cause of malfunction

- (1) Defect of float switch or short circuit connector
- (2) Defect of drain pump
- (3) Drain clogging, upward slope, etc.
- (4) Defect of indoor unit PC board
- (5) Loose connection of connector

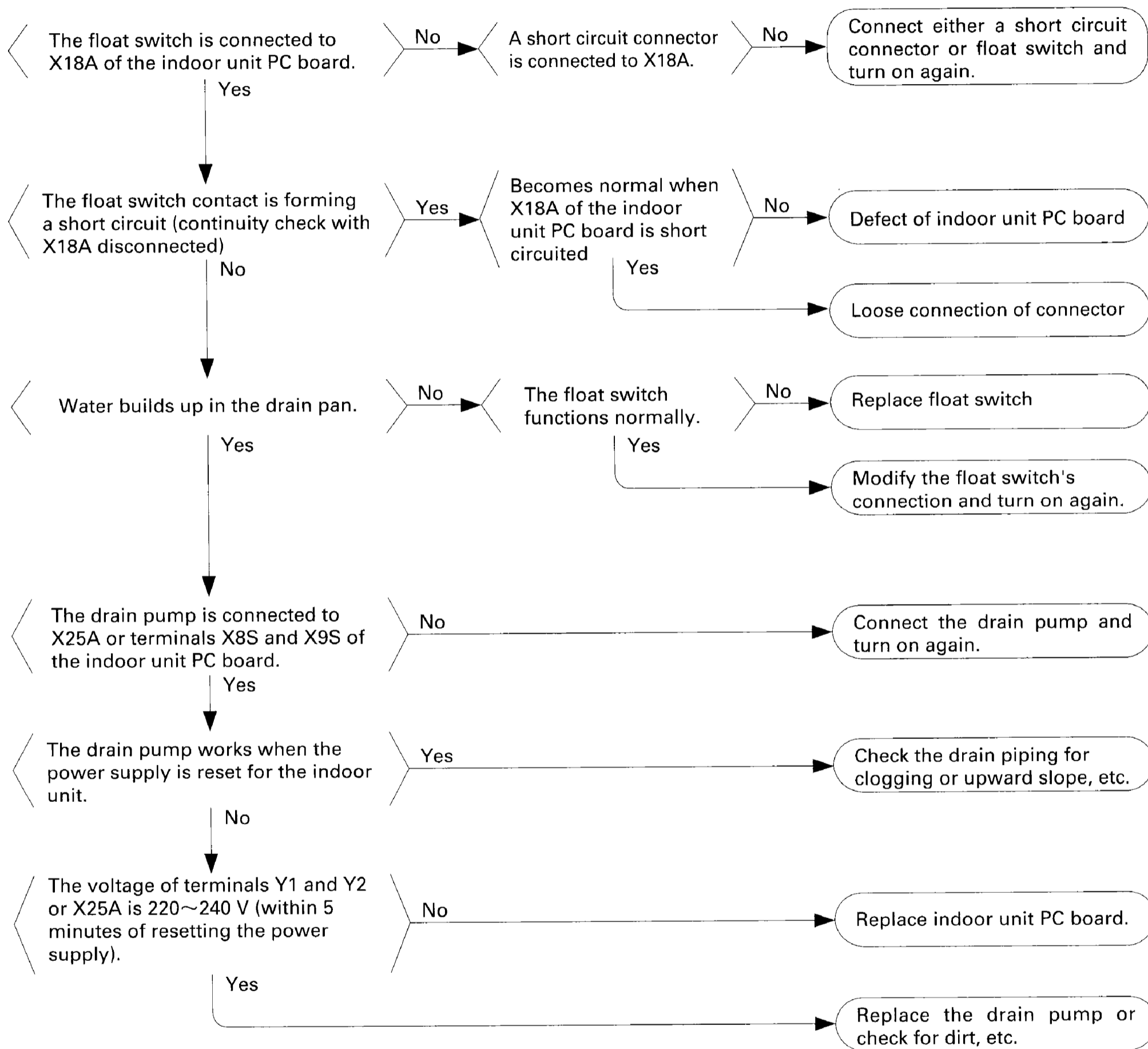

## Remote controller display

### Malfunction code "A6" blinks.

#### Cause of malfunction

(1) Fan motor lock

(2) Disconnected or faulty wiring between fan motor and PC board

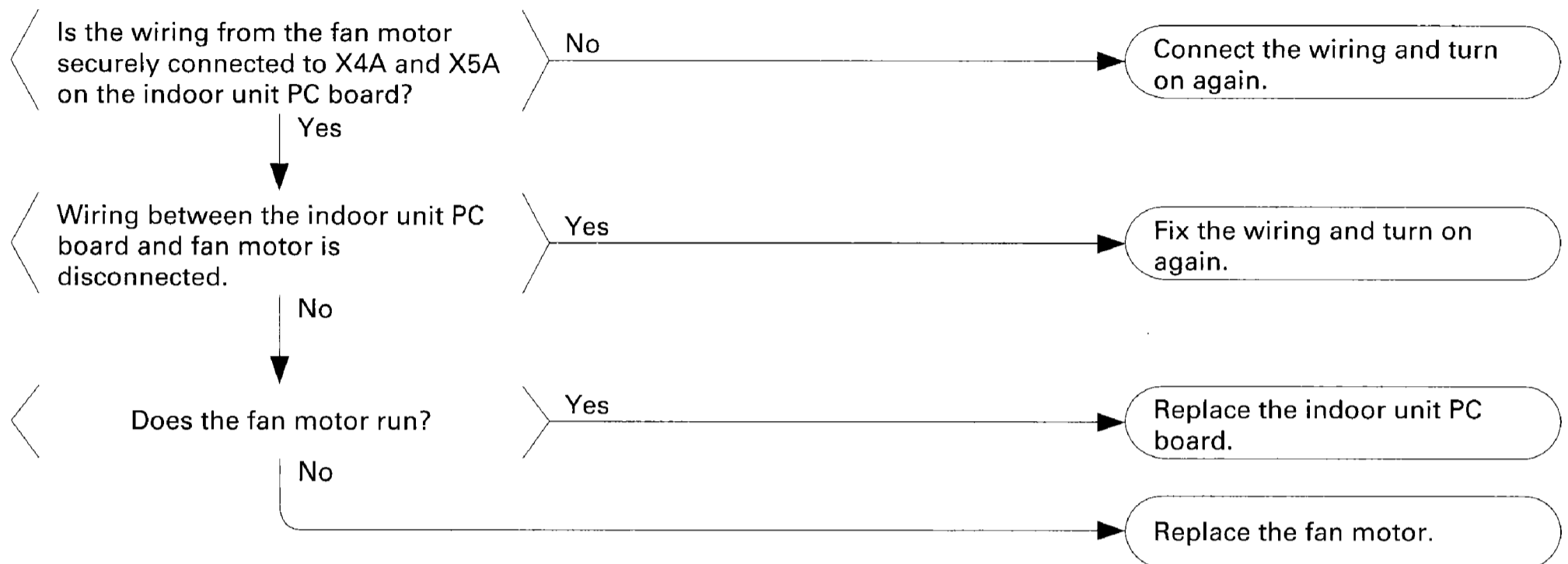

## Remote controller display

### Malfunction code "A7" blinks.

#### Cause of malfunction

- (1) Defect of swing motor
- (2) Defect of connection cable (power supply and limit switch)
- (3) Defect of air flow direction adjusting flap-cam
- (4) Defect of indoor unit PC board

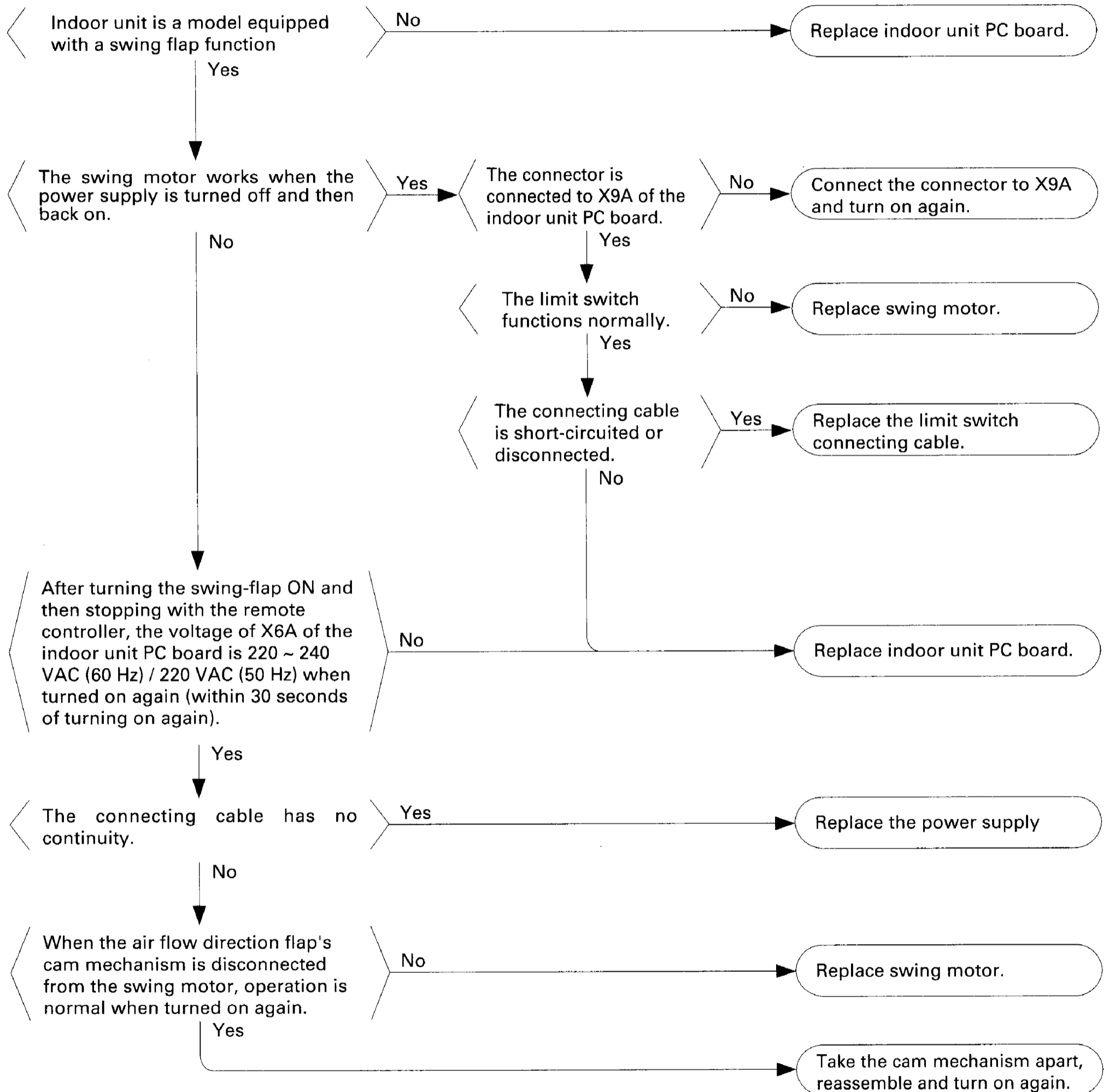

## Remote controller display

### Malfunction code "A9" blinks.

#### Cause of malfunction

- (1) Malfunction of moving part of electronic expansion valve
- (2) Defect of indoor unit PC board
- (3) Defect of connecting cable

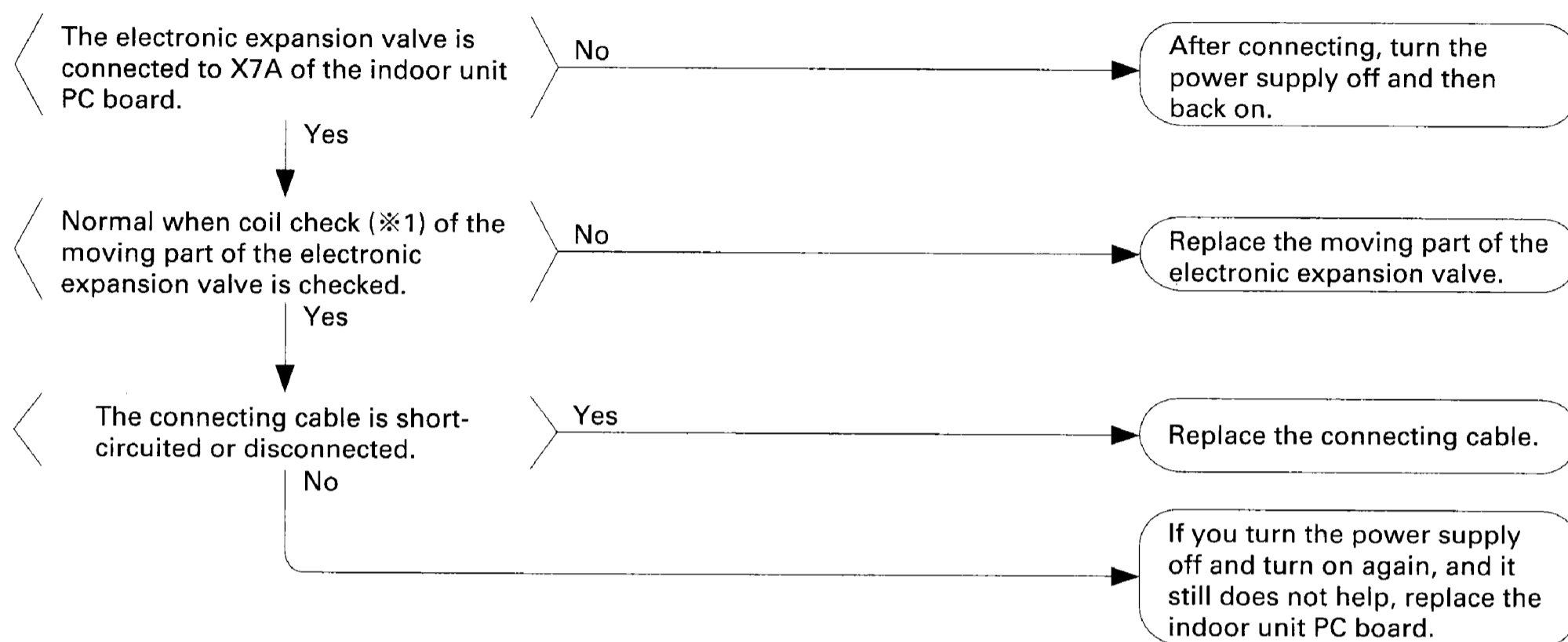

※1: Coil check method for the moving part of the electronic expansion valve

(Normal)

Pin No.	①White	②Yellow	③Orange	④Blue	⑤Red	⑥Brown
①White		X	○ Approx. 300 Ω	X	○ Approx. 150 Ω	X
②Yellow			X	○ Approx. 300 Ω	X	○ Approx. 150 Ω
③Orange				X	○ Approx. 150 Ω	X
④Blue					X	○ Approx. 150 Ω
⑤Red						X
⑥Brown						

○: Continuity

X: No continuity

## Remote controller display

### Malfunction code "AF" blinks.

#### Cause of malfunction

- (1) Humidifier unit (optional accessory) leaking
- (2) Defect of drain pipe (upward slope, etc.)
- (3) Defect of indoor unit PC board

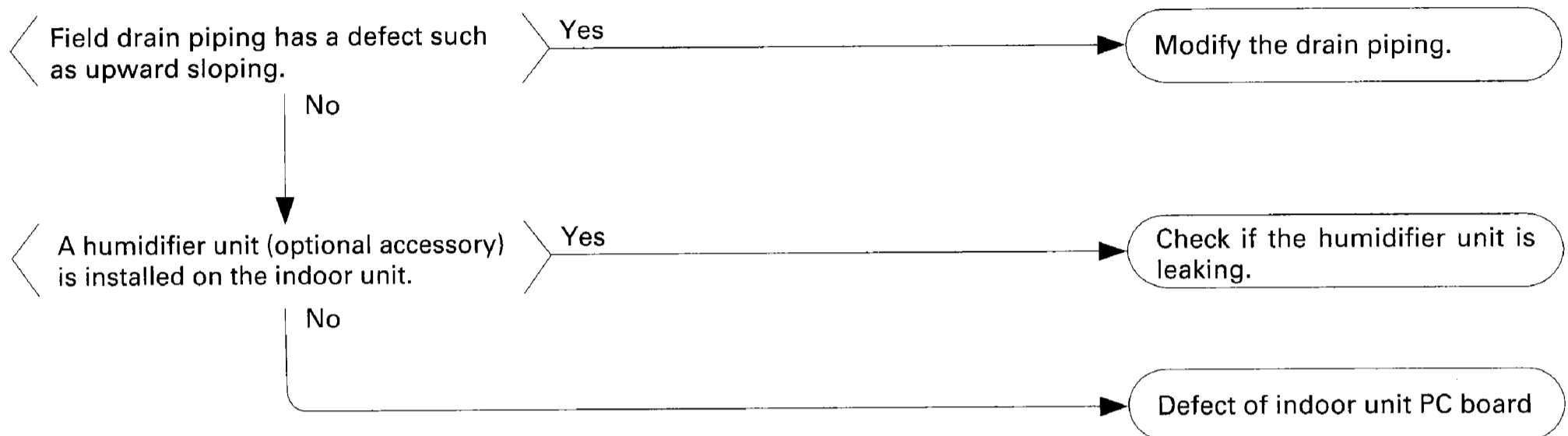



## Remote controller display

### Malfunction code "AJ" blinks.

#### Cause of malfunction

(1) You have forgotten to install the capacity setting adaptor.

(2) Defect of indoor unit PC board

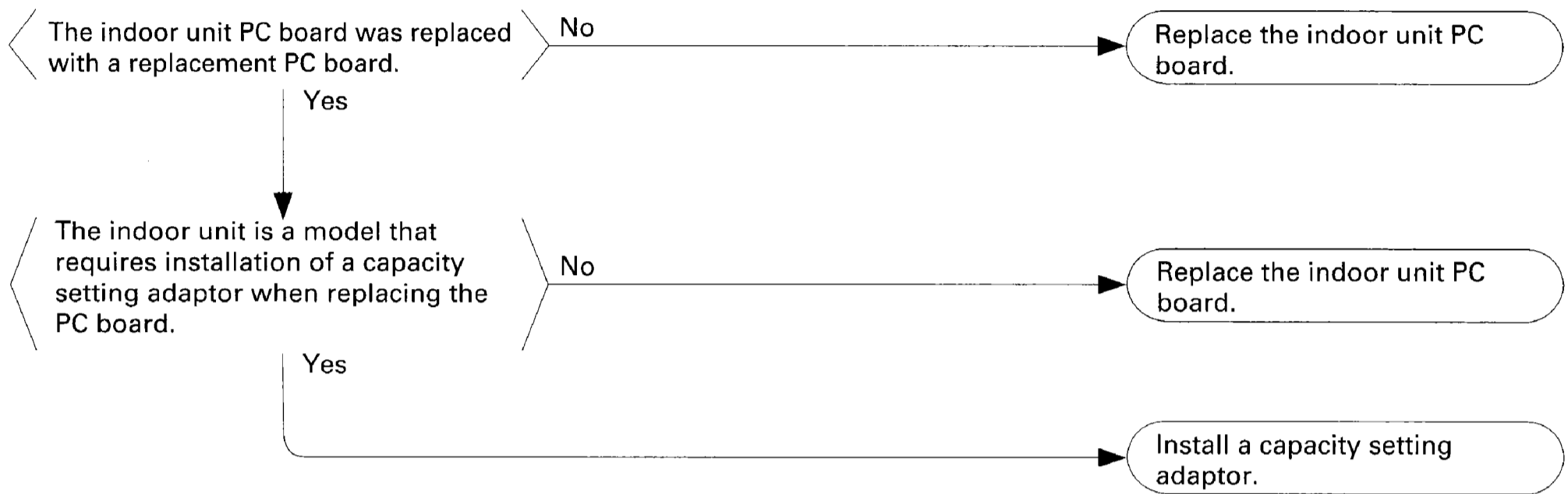

## Remote controller display

### Malfunction code "C4" blinks.

#### Cause of malfunction

(1) Defect of thermistor (R2T) for liquid pipe

(2) Defect of indoor unit PC board

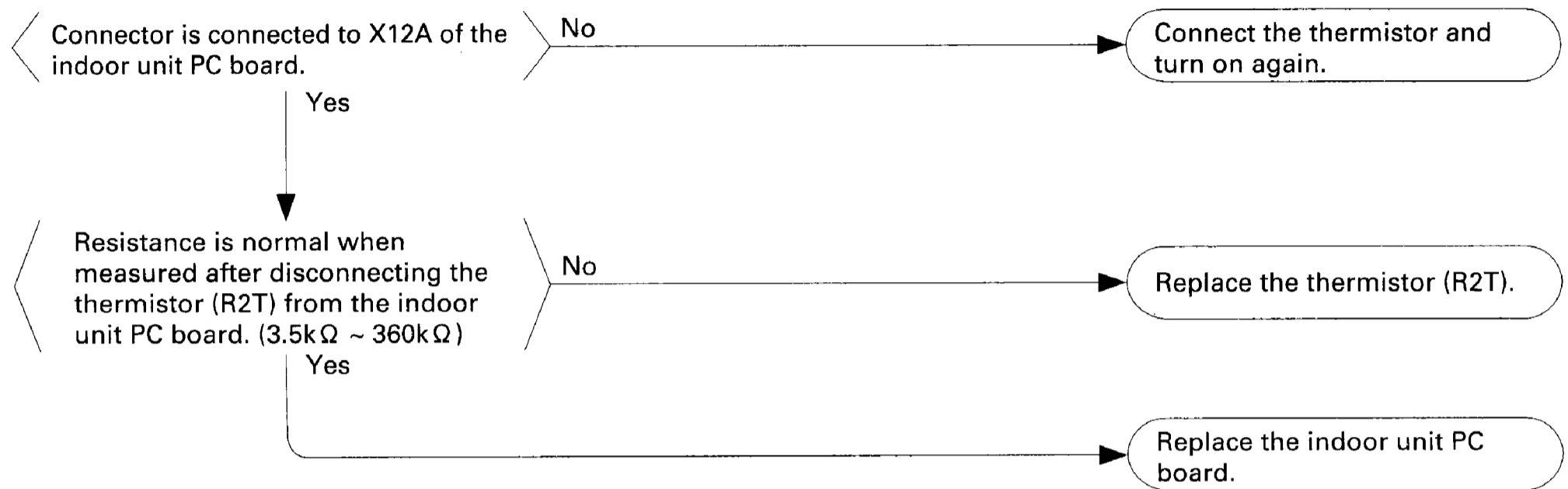

## Remote controller display

### Malfunction code "C5" blinks.

#### Cause of malfunction

(1) Defect of indoor unit thermistor (R3T) for gas pipe

(2) Defect of indoor unit PC board

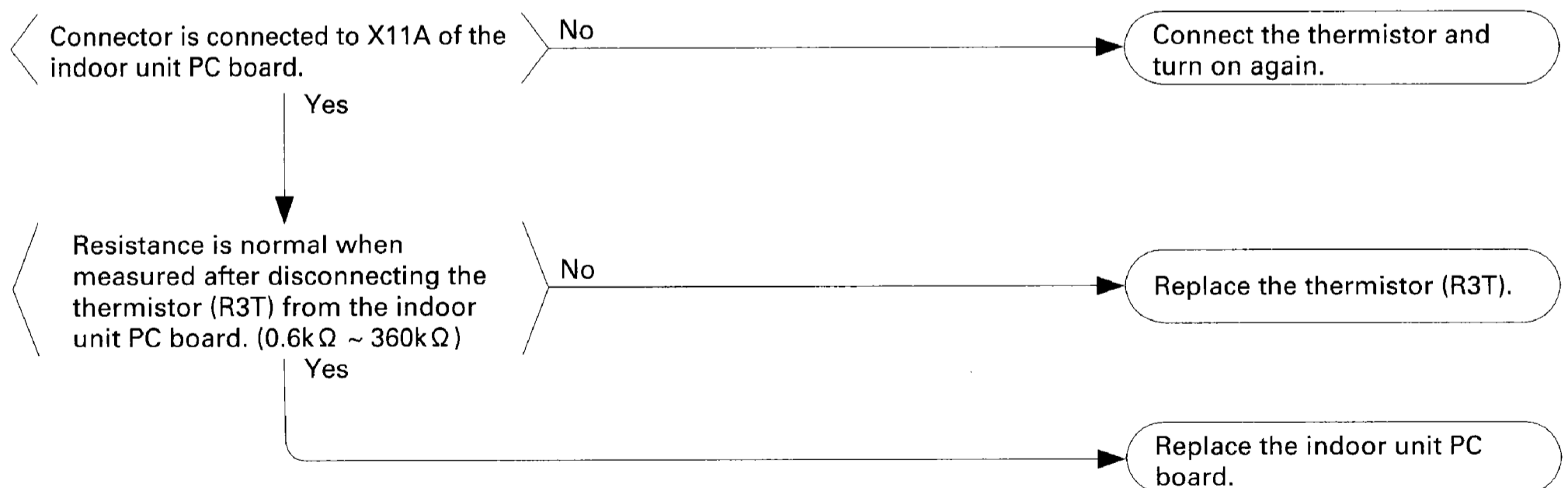

## Remote controller display

### Malfunction code "C9" blinks.

#### Cause of malfunction

- (1) Defect of indoor unit thermistor (R1T) for air inlet
- (2) Defect of indoor unit PC board

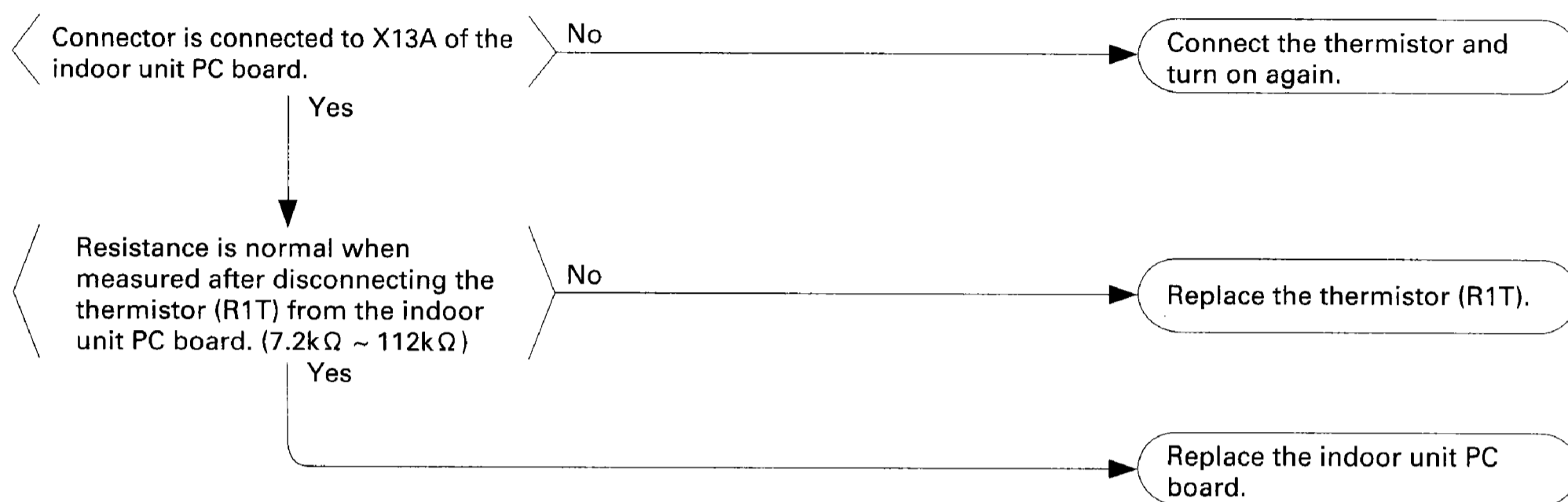

## Remote controller display

### Malfunction code "CJ" blinks.

#### Cause of malfunction

- (1) Defect of remote controller thermistor
- (2) Defect of remote controller PC board

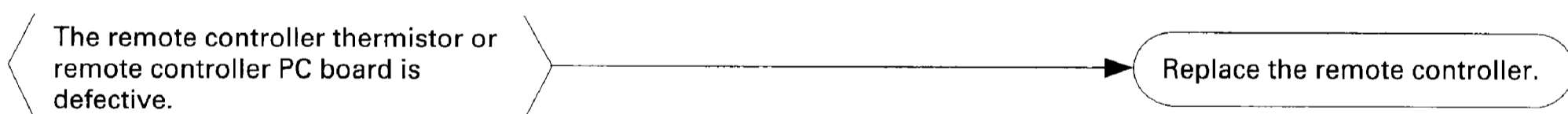

## Remote controller display

### Malfunction code "E0" blinks.

#### Cause of malfunction

- (1) Actuation of outdoor unit safety device
- (2) Defect of outdoor unit PC board
- (3) Instantaneous power failure

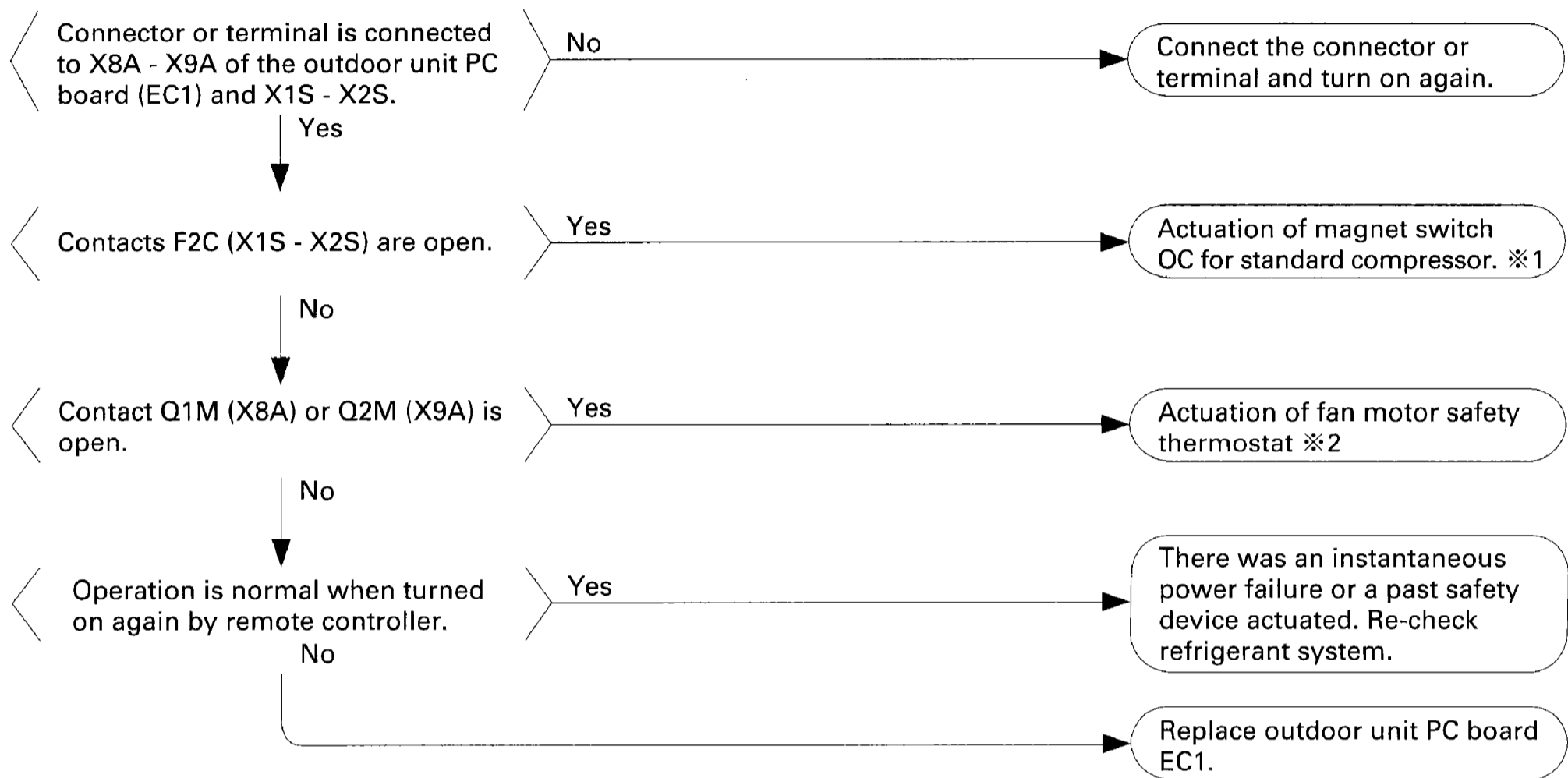

※1: Actuation of magnet switch OC  
Defect of compressor  
Power supply insufficient  
Defect of magnet switch, etc.

※2: Actuation of fan motor safety thermostat  
Defect of fan motor  
Defect of capacitor, etc.

## Remote controller display

### Malfunction code "E1" blinks.

#### Cause of malfunction

- (1) Defect of outdoor unit PC board (EC1)

Replace outdoor unit PC board EC1.

## Remote controller display

### Malfunction code "E3" blinks.

#### Cause of malfunction

- (1) Actuation of outdoor unit high pressure switch
- (2) Defect of outdoor unit PC board (EC1)
- (3) Instantaneous power failure

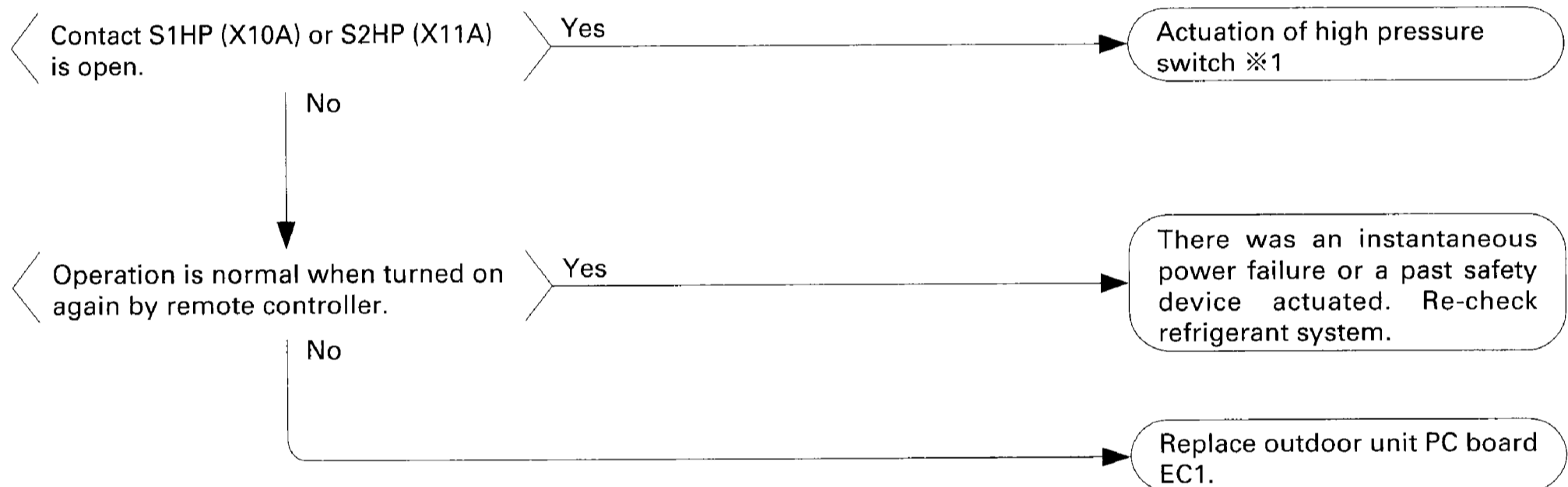

#### \*1: Actuation of high pressure switch (HPS)

The outdoor unit PC board's connector is disconnected.

Is the outdoor unit heat exchanger dirty?

Defect of outdoor fan

Is the refrigerant over-filled?

## Remote controller display

### Malfunction code "E4" blinks.

#### Cause of malfunction

- (1) Abnormal drop of low pressure (0 kg/cm<sup>2</sup> [0 MPa])
- (2) Defect of low pressure sensor
- (3) Defect of outdoor unit PC board

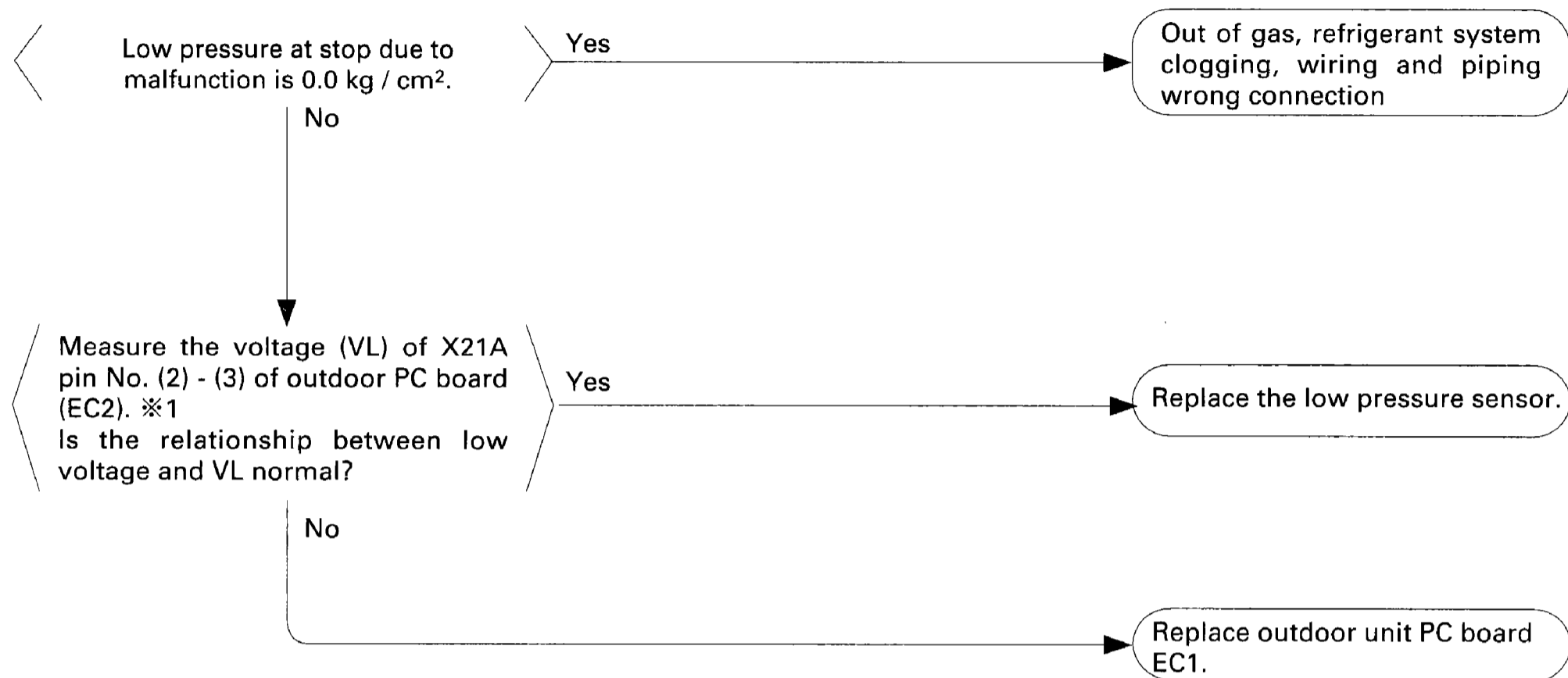

※1: Voltage measurement point

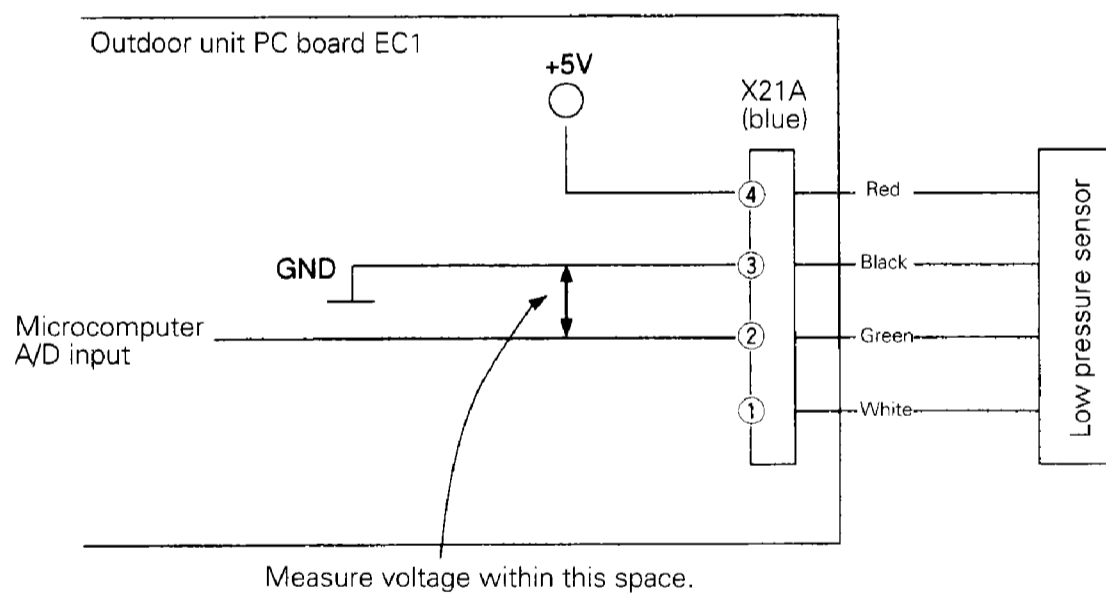

※Refer to the pressure sensor, pressure - voltage characteristics table on P321.

## Remote controller display

### Malfunction code "E9" blinks.

#### Cause of malfunction

(1) Defect of moving part of electronic expansion valve

(2) Defect of outdoor unit PC board (EC1)

(3) Defect of connecting cable

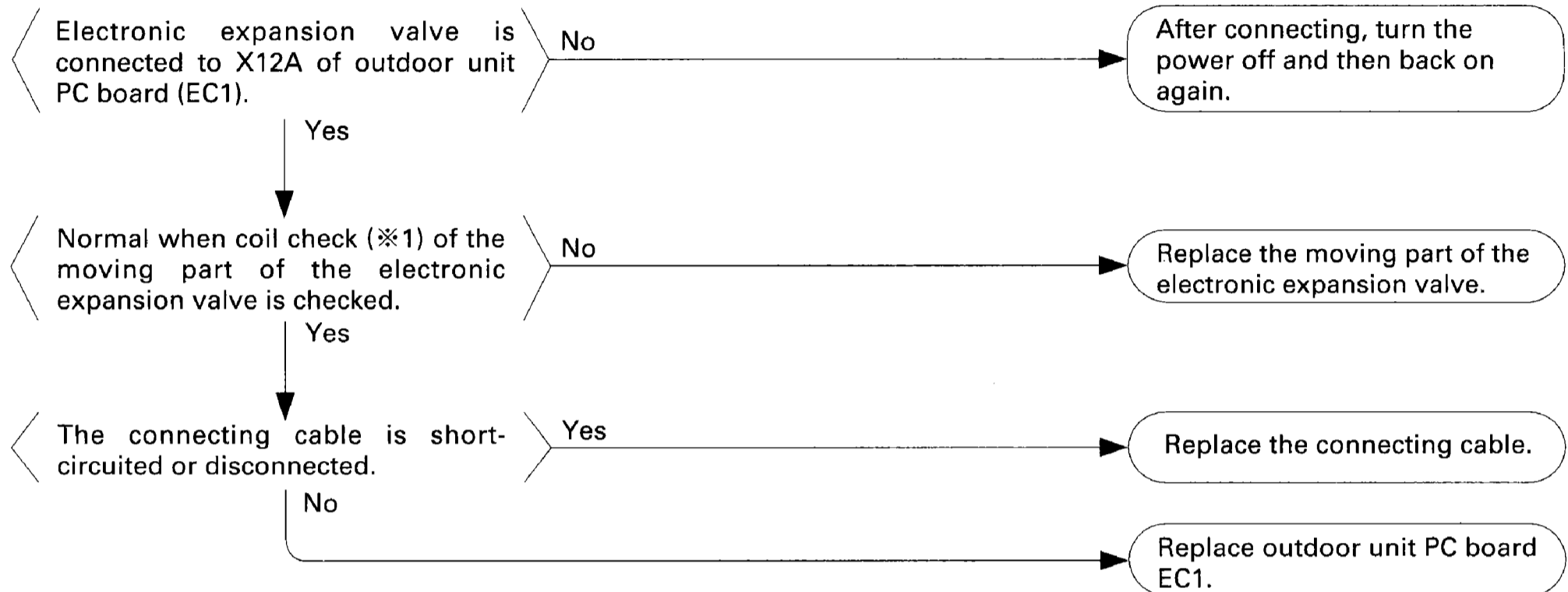

#### ※1 Coil check method for the moving part of the electronic expansion valve

Disconnect the electronic expansion valve from the PC board and check the continuity between the connector pins.

(Normal)

Pin No.	①White	②Yellow	③Orange	④Blue	⑤Red	⑥Brown
①White		×	⊙	×	○	×
②Yellow			×	⊙	×	○
③Orange				×	○	×
④Blue					×	○
⑤Red						×
⑥Brown						

⊙: Continuity  
Approx. 300Ω  
○: Continuity  
Approx. 150Ω  
×: No continuity

## Remote controller display

### Malfunction code "F3" blinks.

#### Cause of malfunction

- (1) Abnormal discharge pipe temperature
- (2) Defect of discharge pipe thermistor (5K: R3T 8K, 10K: R3-1T, R3-2T)
- (3) Defect of outdoor unit PC board
- (4) Discharge pipe thermistor wrong connection
- (5) Liquid injection solenoid valve wrong connection

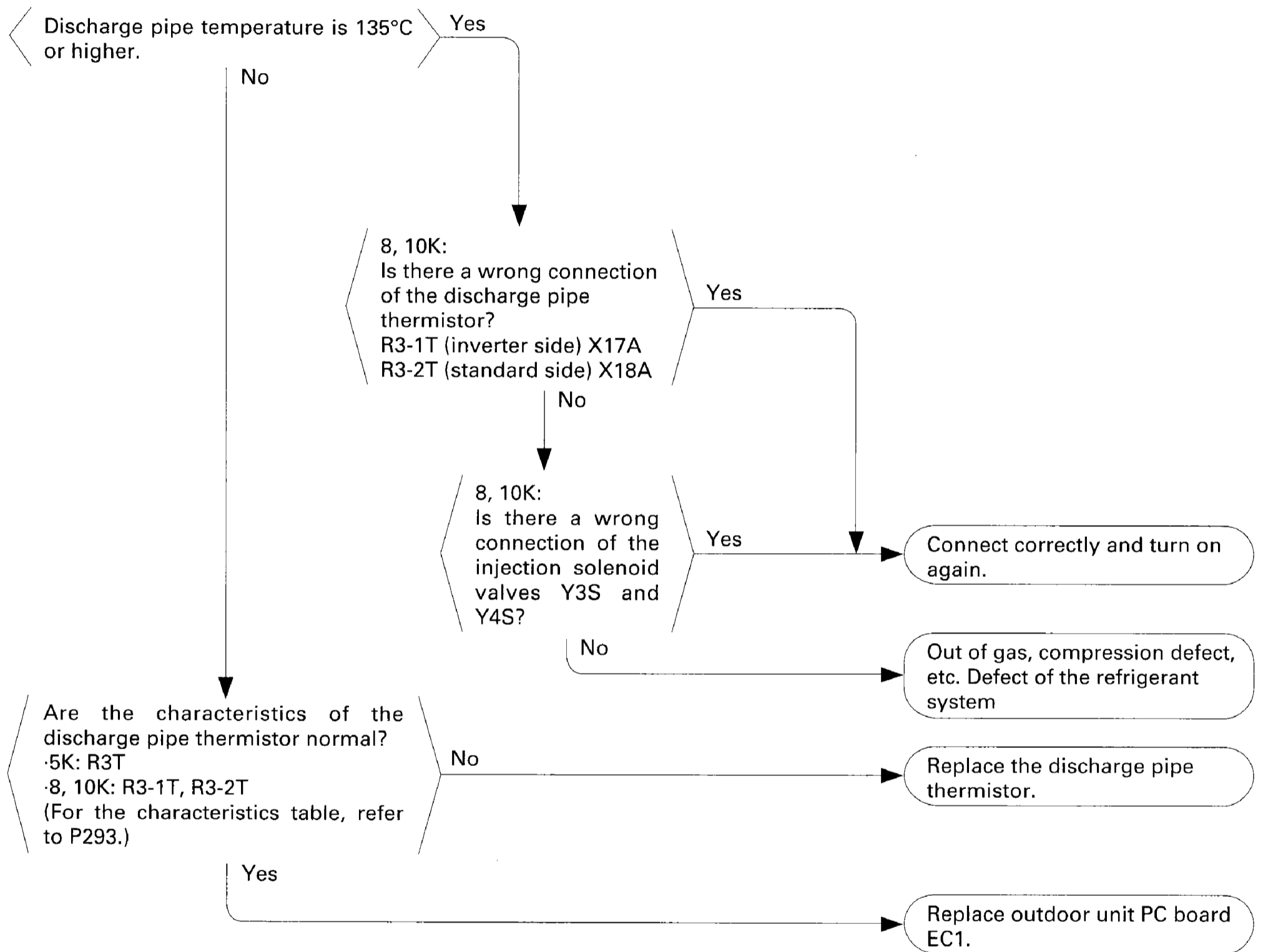



## Remote controller display

### Malfunction code "H9" blinks.

#### Cause of malfunction

(1) Defect of thermistor (R1T) for outdoor unit outdoor air intake

(2) Defect of outdoor unit PC board (EC1)

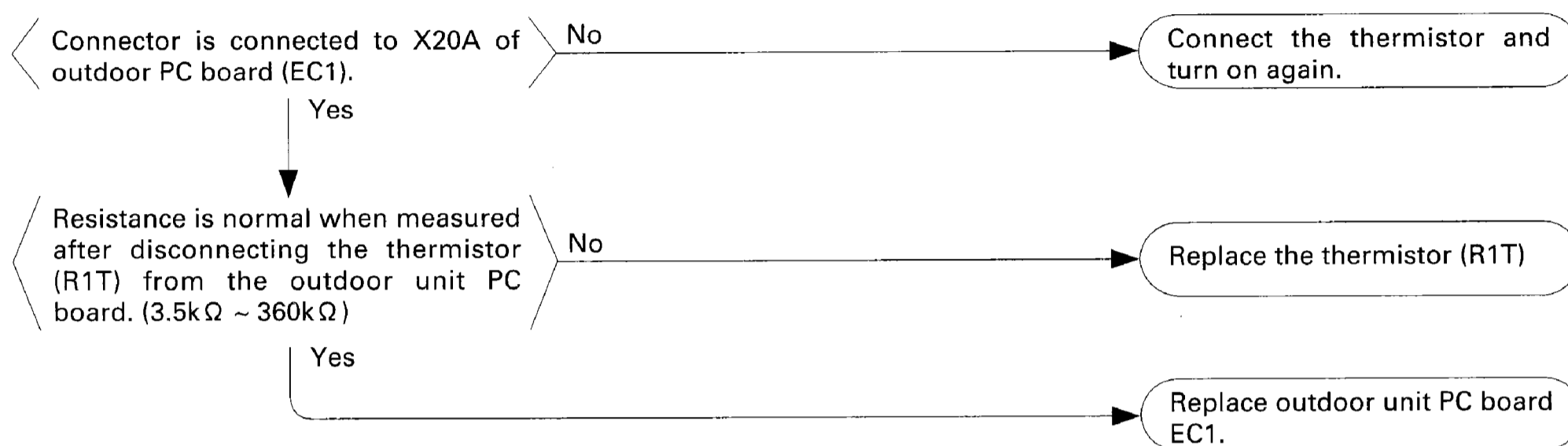

The alarm indicator is displayed when the fan is being used also.

## Remote controller display

### Malfunction code "J3" blinks.

#### Cause of malfunction

(1) Defect of thermistor (R3T, R3-1T, R3-2T) for outdoor unit discharge pipe

(2) Defect of outdoor unit PC board (EC1)

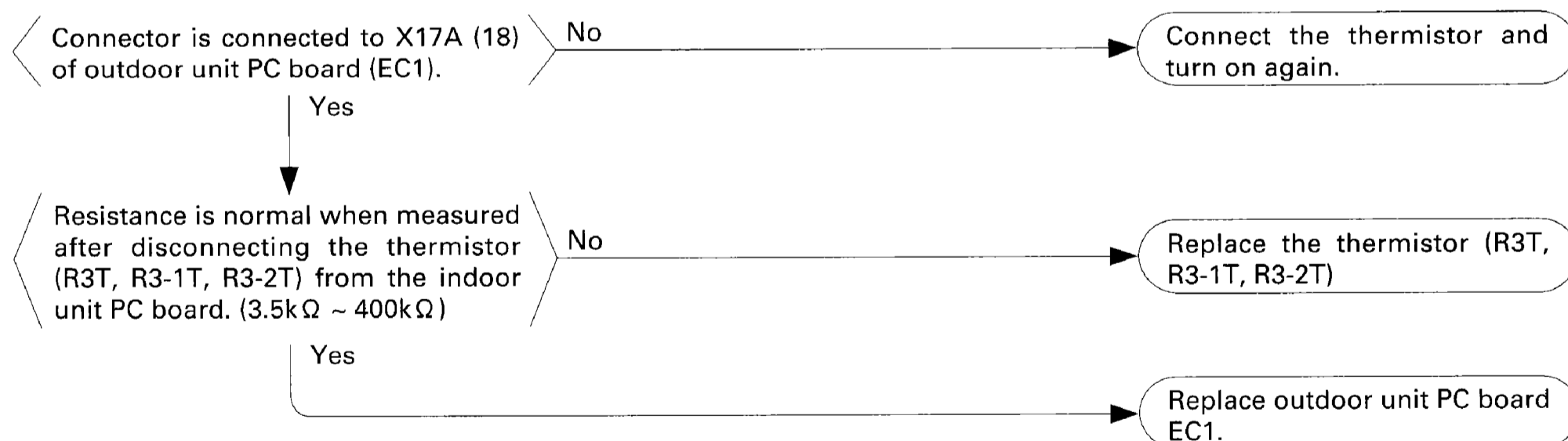

The alarm indicator is displayed when the fan is being used also.

## Remote controller display

### Malfunction code "J5" blinks.

#### Cause of malfunction

(1) Defect of thermistor (R4T) for outdoor unit suction pipe

(2) Defect of outdoor unit PC board (EC1)

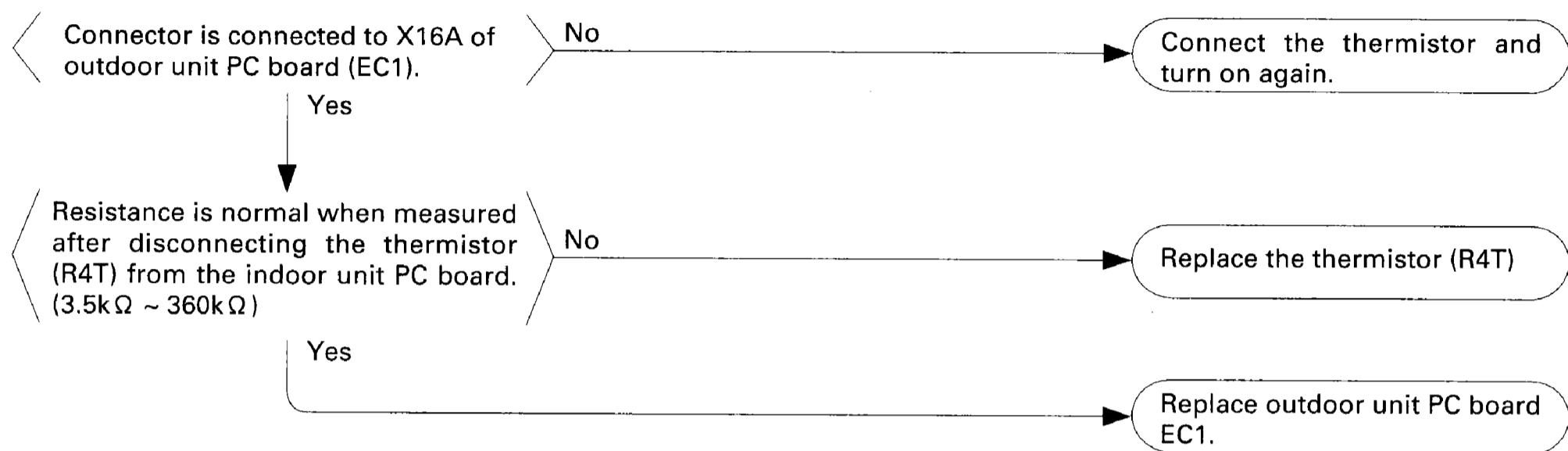

The alarm indicator is displayed when the fan is being used also.

## Remote controller display

### Malfunction code "J6" blinks.

#### Cause of malfunction

(1) Defect of thermistor (R2T) for outdoor unit coil

(2) Defect of outdoor unit PC board (EC1)

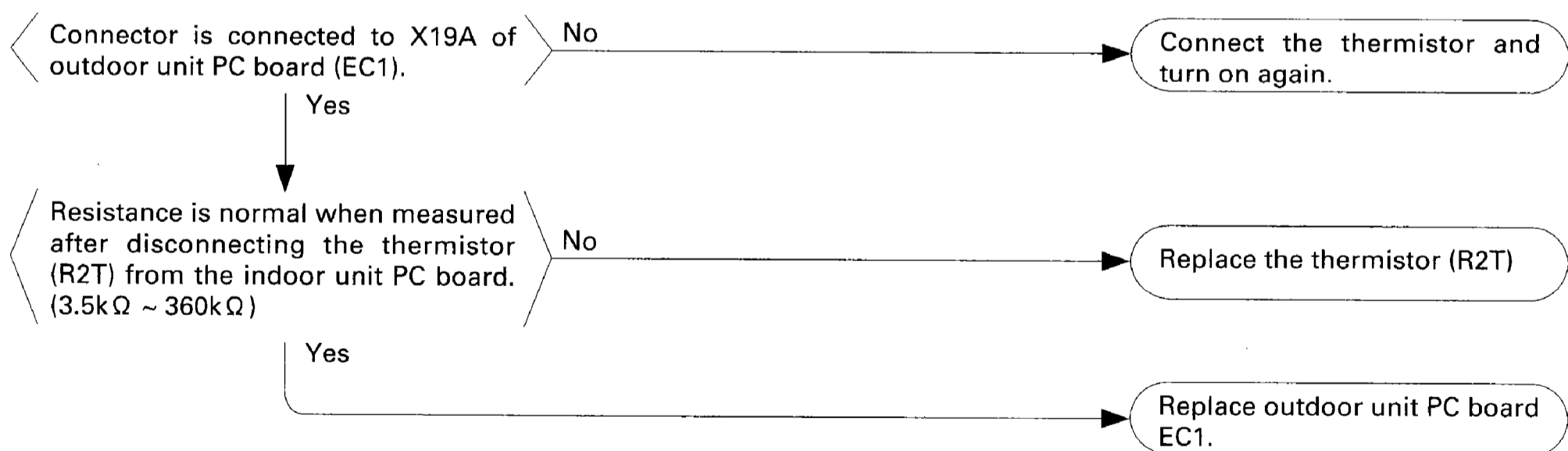

The alarm indicator is displayed when the fan is being used also.

Remote controller display  
Malfunction code "JA" blinks.

Cause of malfunction

- (1) Defect of high pressure sensor system
- (2) Connection of low pressure sensor with wrong connection.
- (3) Defect of outdoor unit PC board.

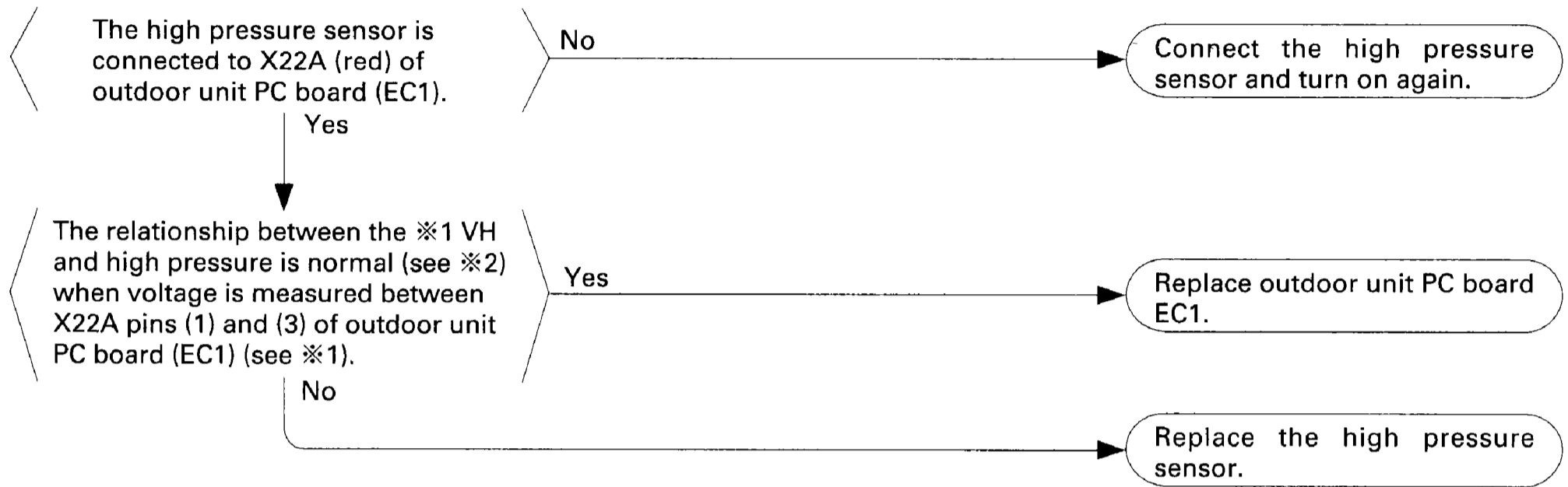

※1: Voltage measurement point

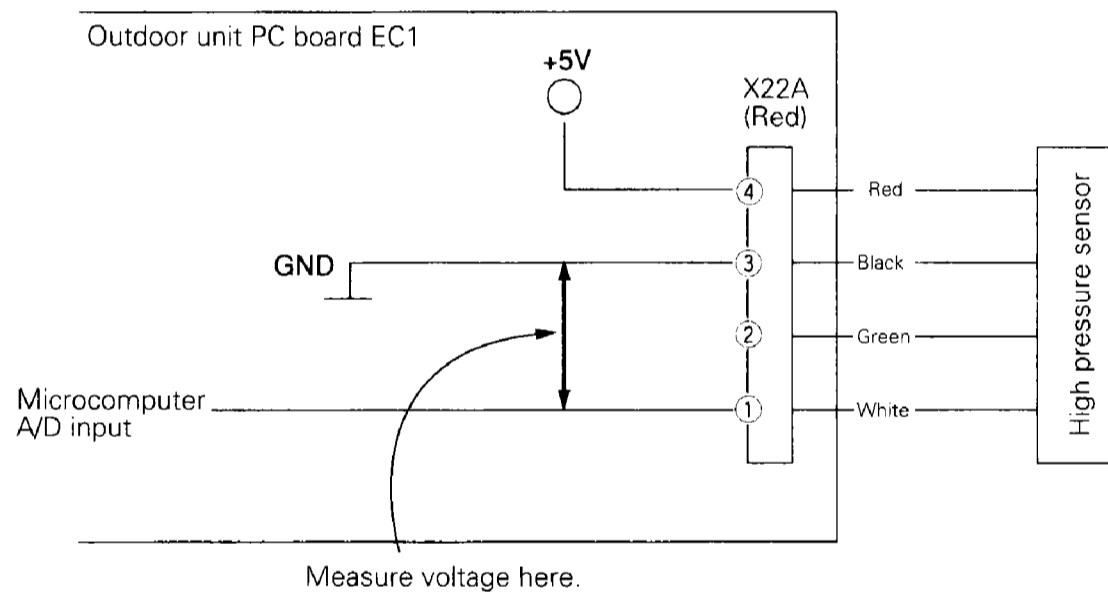

※2: Refer to pressure sensor, pressure / voltage characteristics table, P321.

## Remote controller display

### Malfunction code "JC" blinks.

#### Cause of malfunction

- (1) Defect of low pressure sensor system
- (2) Connection of high pressure sensor with wrong connection.
- (3) Defect of outdoor unit PC board.

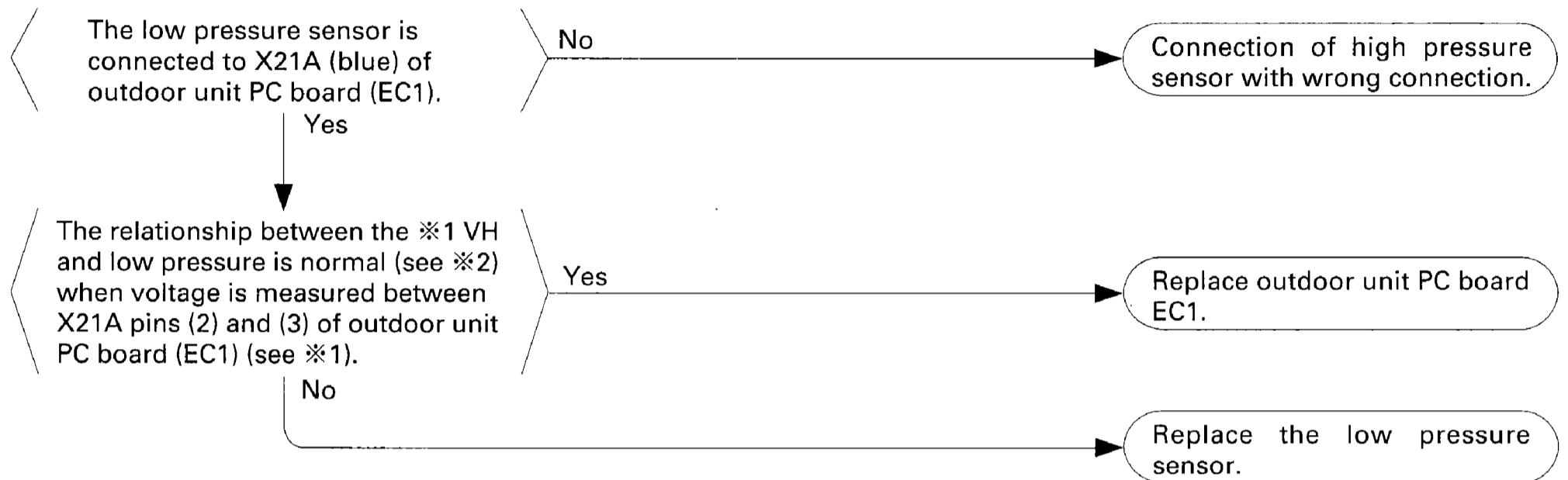

※1: Voltage measurement point

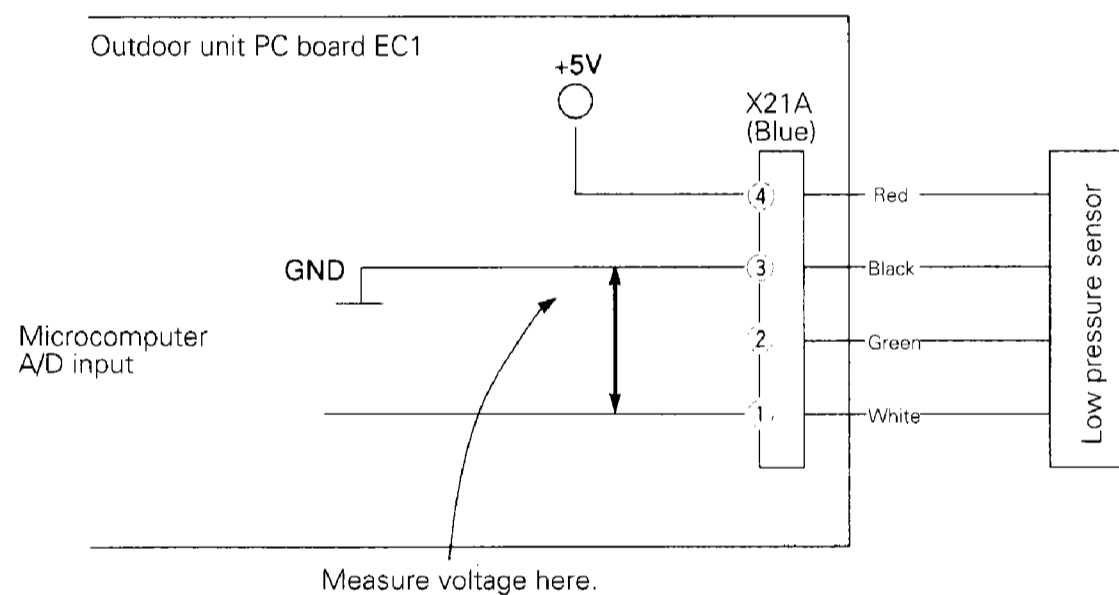

※2: Refer to pressure sensor, pressure/voltage characteristics table, P321.

## Remote controller display

### Malfunction code "JH" blinks.

#### Cause of malfunction

(1) Defect of oil temperature thermistor (R5T)

(2) Defect of outdoor unit PC board (EC1)

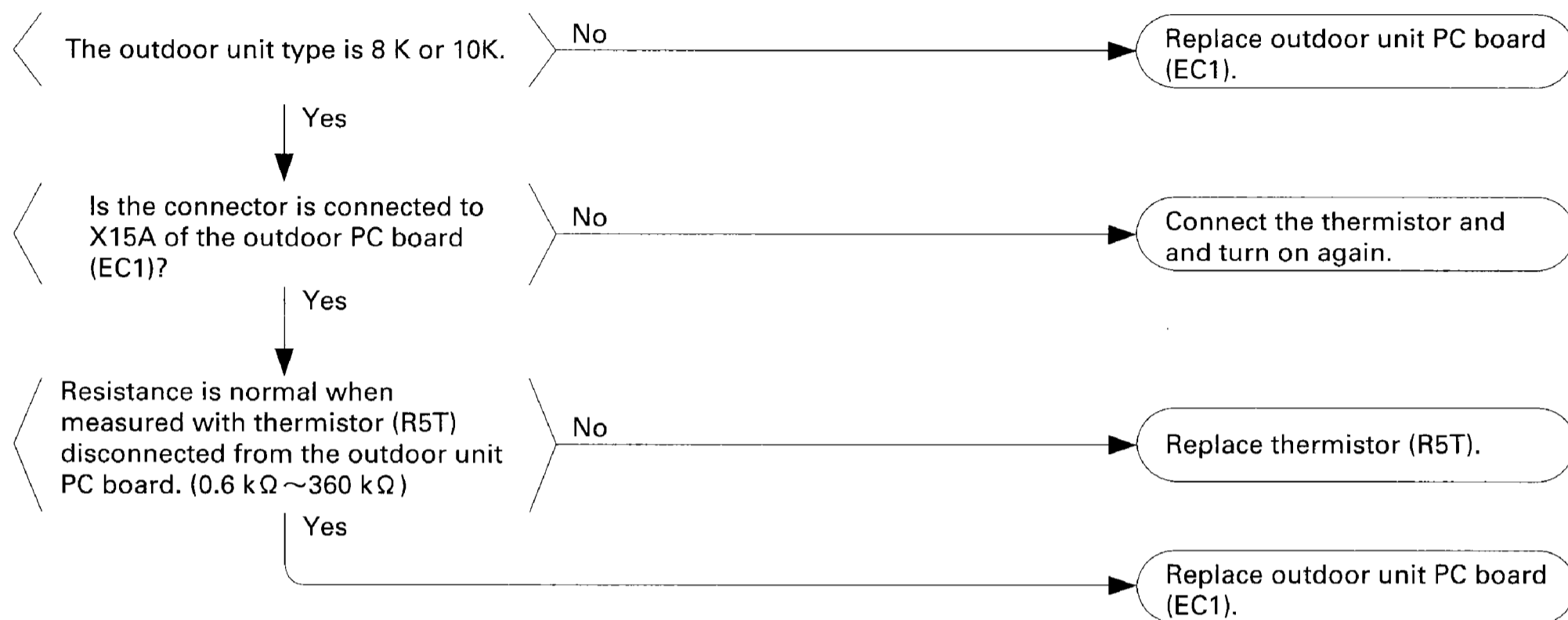

## Remote controller display

### Malfunction code "U0" blinks.

#### Cause of malfunction

- (1) Out of gas or refrigerant system clogging (incorrect piping)
- (2) Defect of pressure sensor
- (3) Defect of outdoor unit PC board

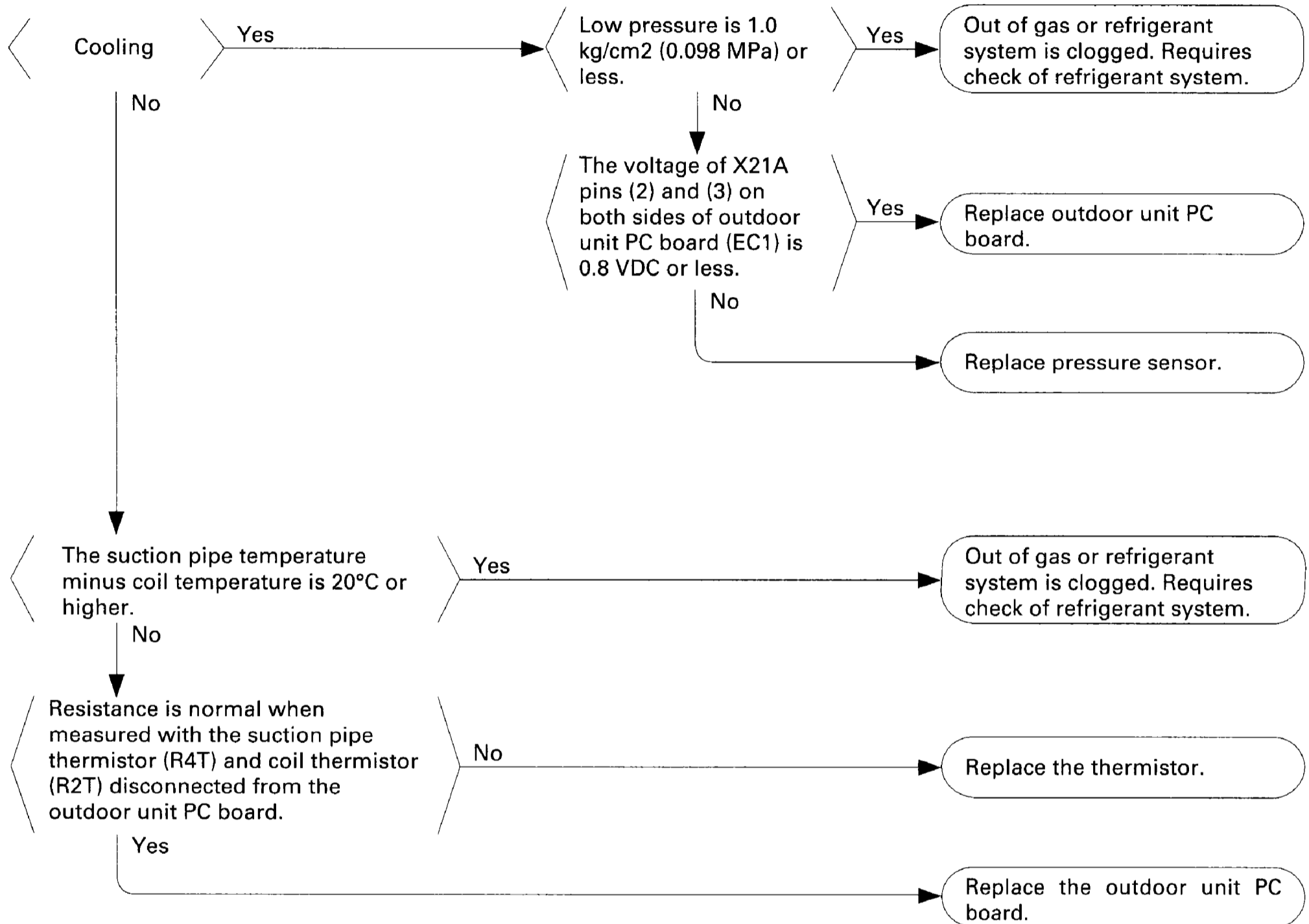

## Remote controller display

### Malfunction code "U1" blinks.

#### Cause of malfunction

- (1) Power supply negative phase
- (2) Power supply open phase
- (3) Defect of outdoor PC board EC1

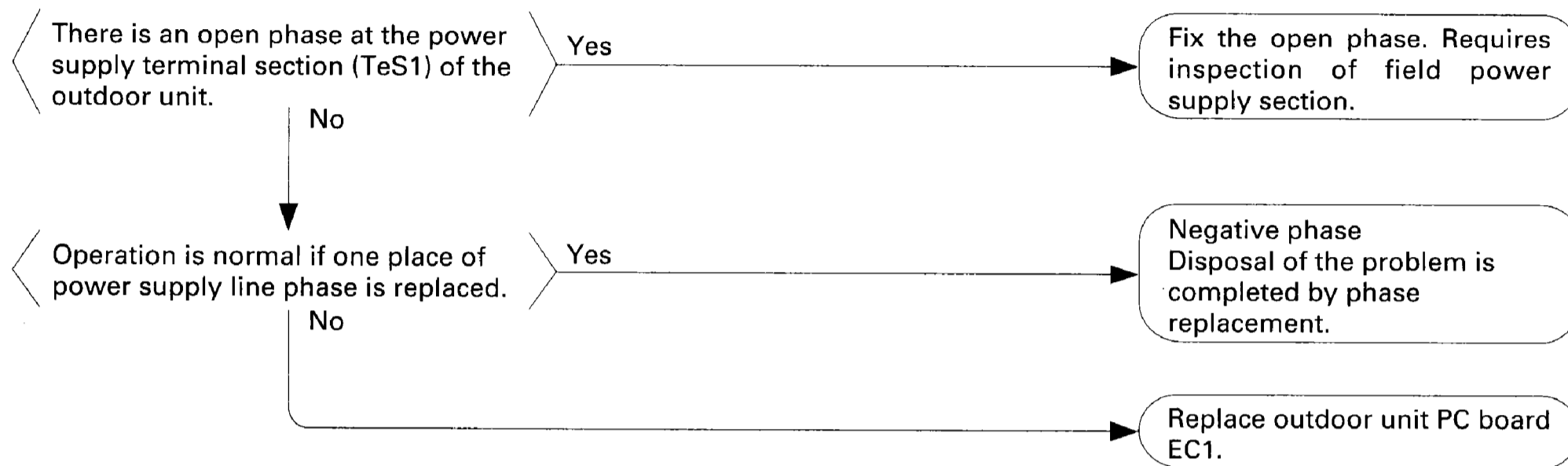

## Remote controller display

### Malfunction code "U4" blinks.

#### Cause of malfunction

- (1) Indoor to outdoor, outdoor to outdoor crossover wiring disconnection, short circuit or wrong check
- (2) Outdoor unit power supply is OFF
- (3) System address doesn't match
- (4) Defect of indoor unit PC board
- (5) Defect of outdoor unit PC board

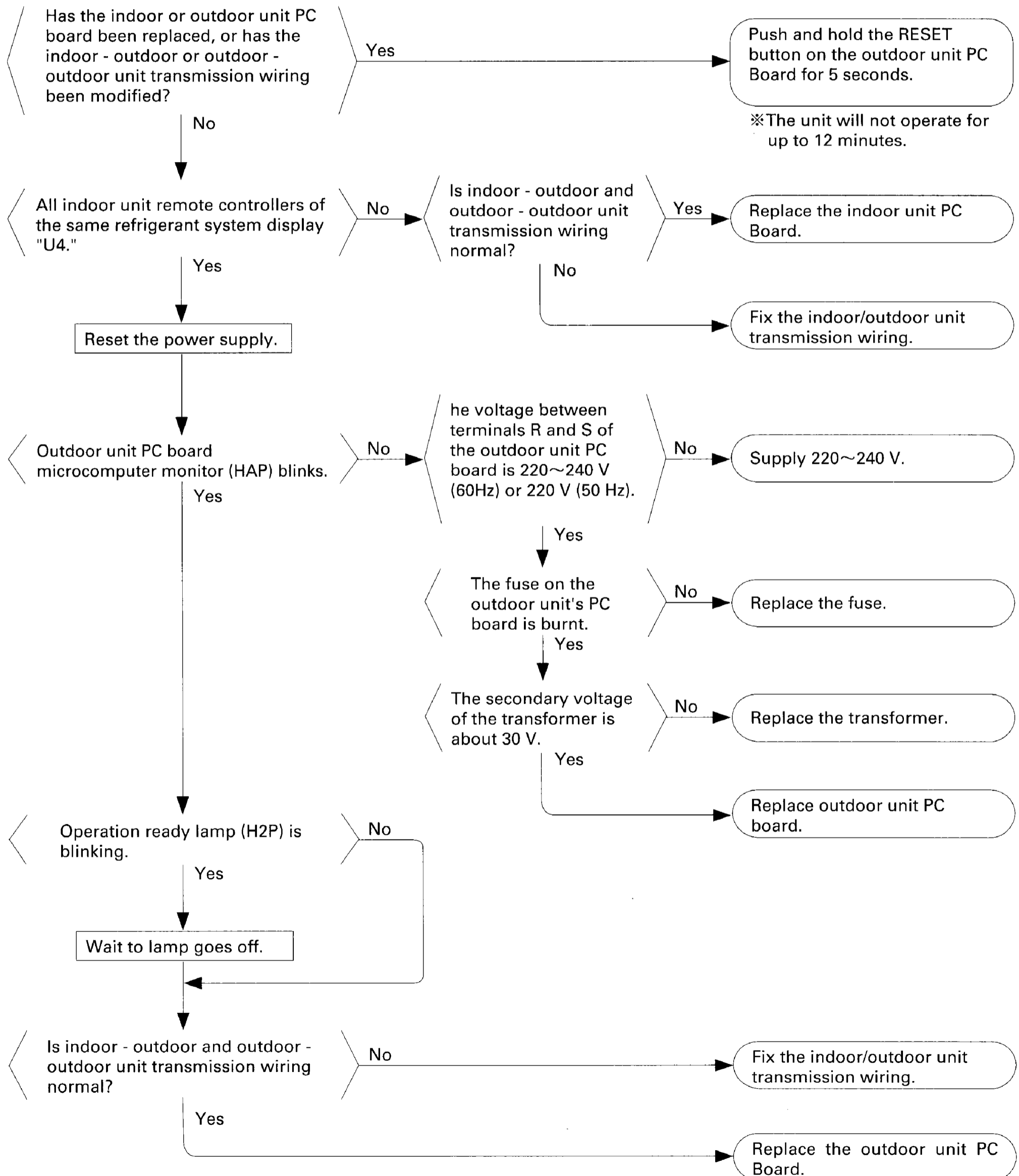



## Remote controller display

### Malfunction code "U5" blinks.

#### Cause of malfunction

- (1) Malfunction of indoor unit remote controller transmission
- (2) Connection of two main remote controllers (when using 2 remote controllers)
- (3) Defect of indoor unit PC board
- (4) Defect of remote controller PC board
- (5) Malfunction of transmission caused by noise

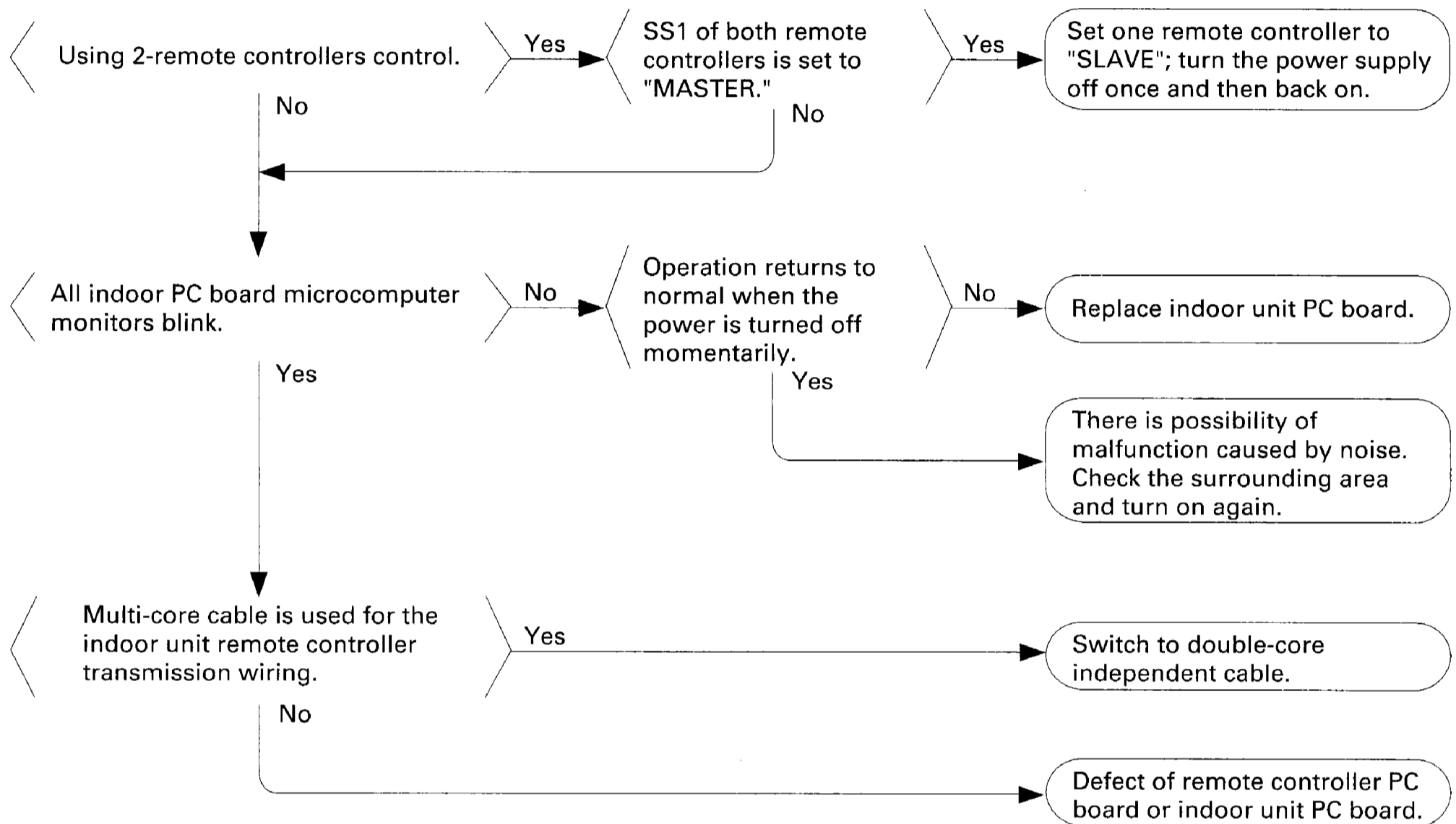

## Remote controller display

### Malfunction code "U7" blinks.

#### Cause of malfunction

- (1) Improper connection of transmission wiring between outdoor unit and outdoor unit outside control adaptor
- (2) Improper cool/heat selection
- (3) Improper cool/heat unified address (outdoor unit, external control adaptor for outdoor unit)
- (4) Defect of outdoor unit PC board (EC1)
- (5) Defect of outdoor unit outside control adaptor

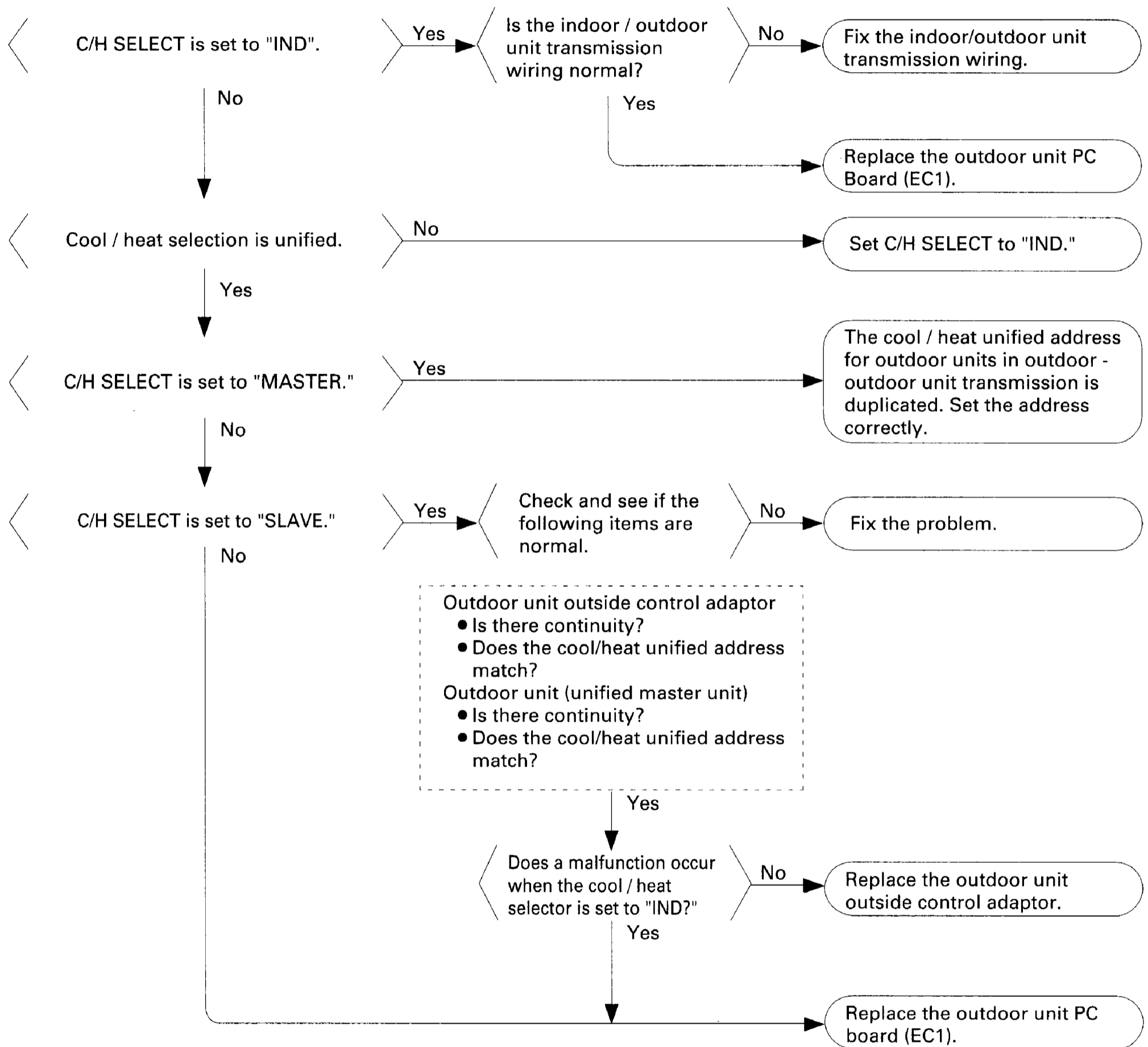

## Remote controller display

### Malfunction code "U8" blinks.

#### Cause of malfunction

- (1) Malfunction of transmission between main and sub remote controller
- (2) Connection between sub remote controllers
- (3) Defect of remote controller PC board

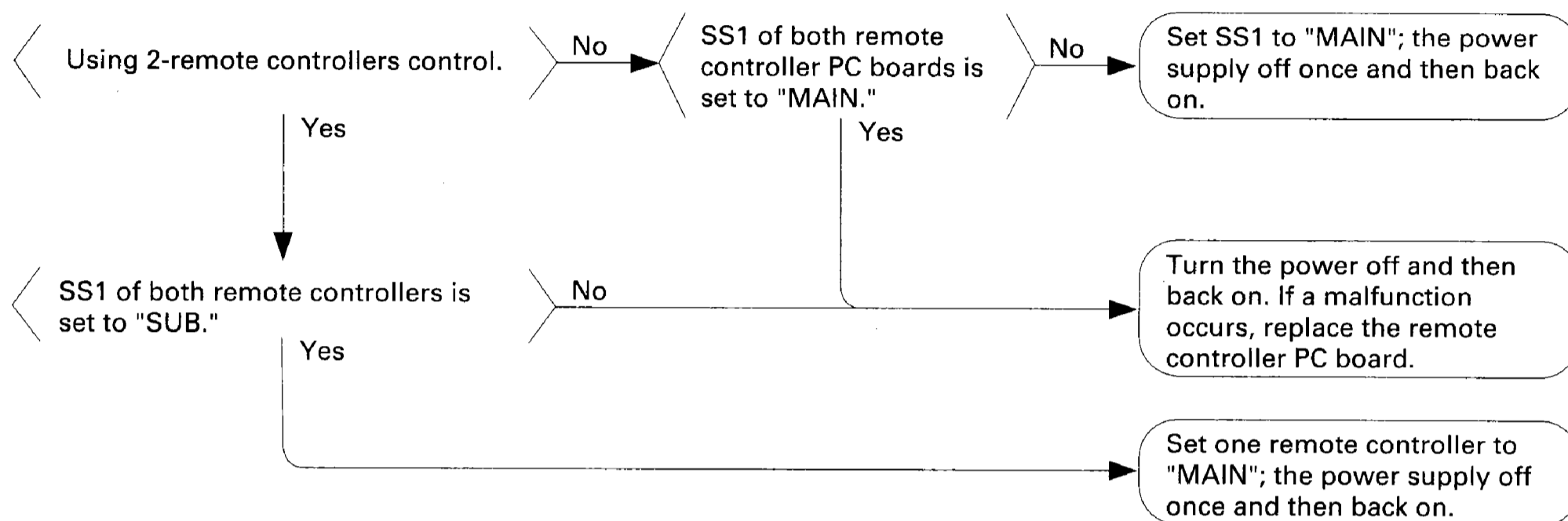

## Remote controller display

### Malfunction code "U9" blinks.

#### Cause of malfunction

- (1) Malfunction of transmission within or outside of other system
- (2) Malfunction of electronic expansion valve in indoor unit of other system
- (3) Defect of PC board of indoor unit in other system
- (4) Improper connection of transmission wiring between indoor and outdoor unit

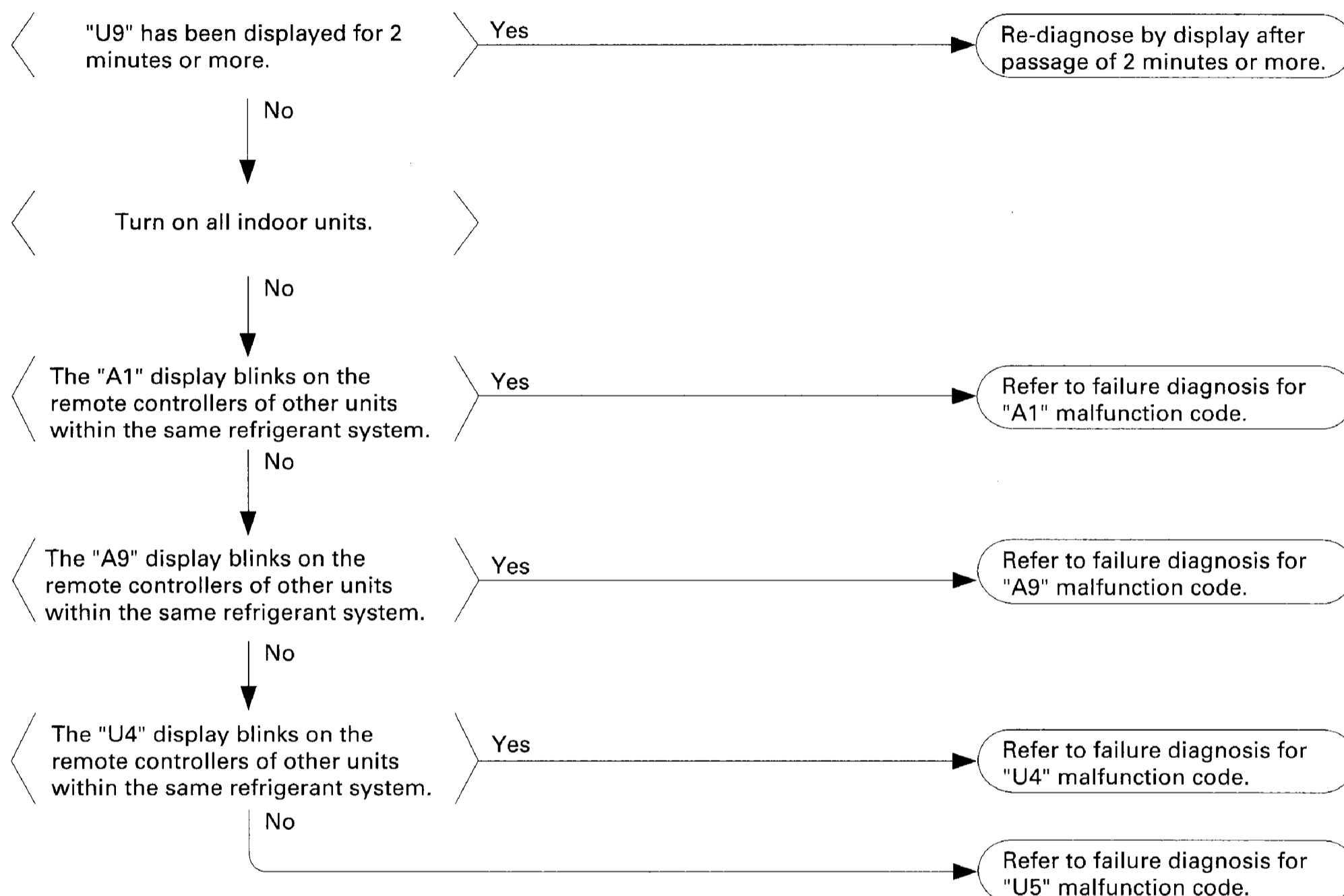

## Remote controller display

### Malfunction code "UA" blinks.

#### Cause of malfunction

- (1) Excess of connected indoor units
- (2) Defect of outdoor unit PC board (EC1)

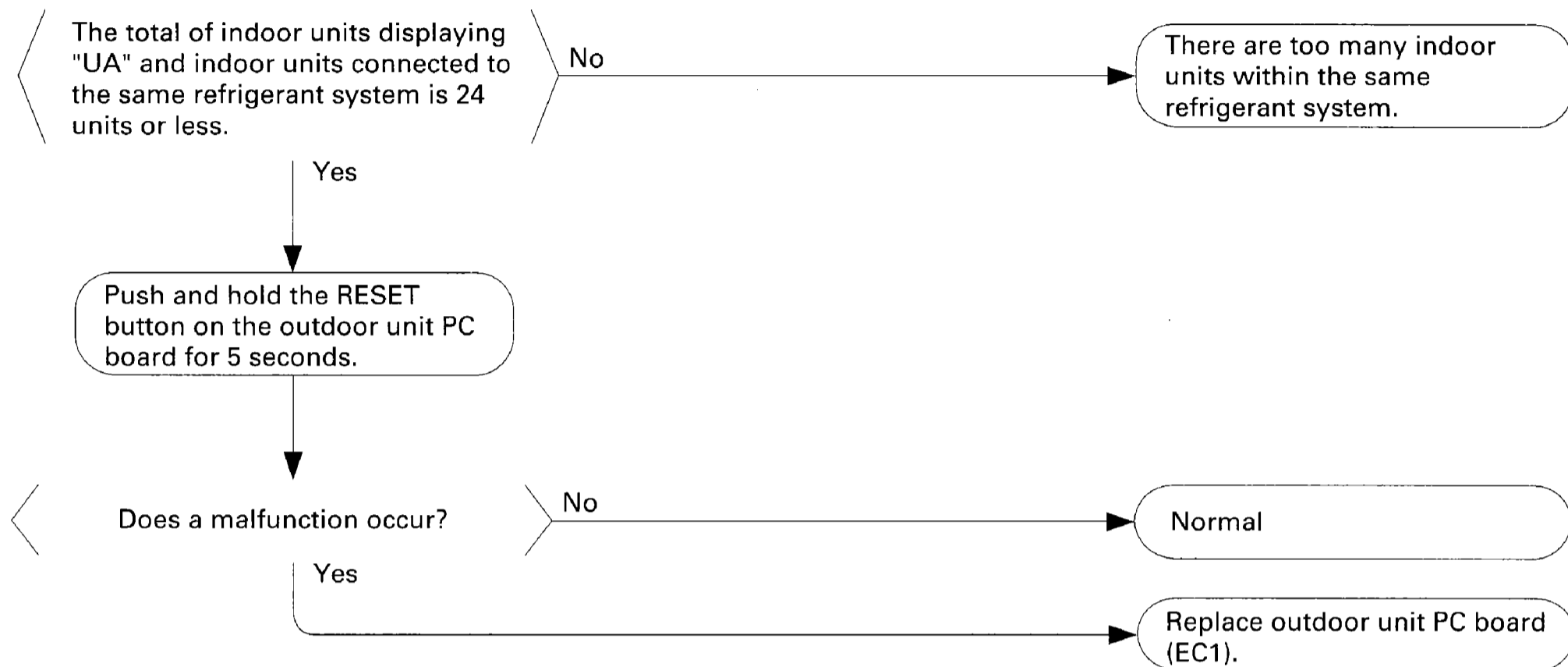

The number of indoor units that can be connected to a single outdoor unit system depends on the type of outdoor unit.

RSXY 5K : Max. 8 units

RSXY 8K : Max. 13 units

RSXY10K : Max. 16 units

## Remote controller display

### Malfunction code "UC" blinks.

#### Cause of malfunction

- (1) Address duplication of central remote controller
- (2) Defect of indoor unit PC board

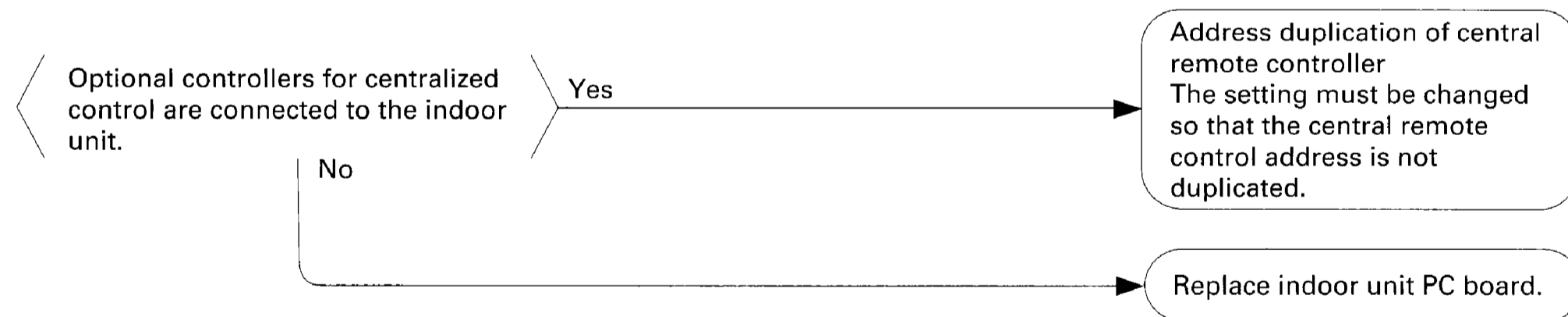

## Remote controller display.

### Malfunction code "UF" blinks.

#### Cause of malfunction

- (1) Improper connection of transmission wiring between outdoor unit and outdoor unit outside control adaptor
- (2) Failure to execute wiring check operation
- (3) Defect of indoor unit PC board

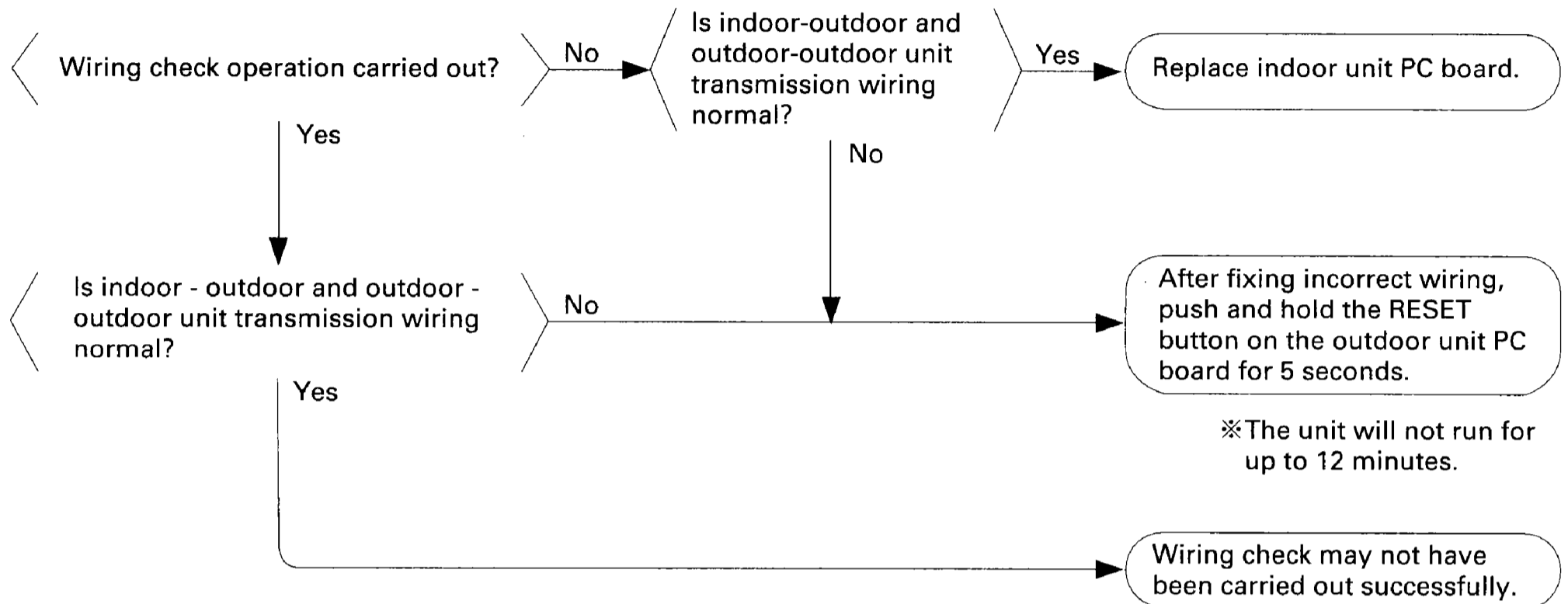

Wiring check may not be successful if carried out after the outdoor unit has been off for more than 12 hours, or if it is not carried out after running all connected indoor units in the fan mode for at least an hour.

## Remote controller display

### Malfunction code "UH" blinks.

#### Cause of malfunction

- (1) Improper connection of transmission wiring between outdoor unit and outdoor unit outside control adaptor
- (2) Defect of indoor unit PC board
- (3) Defect of outdoor unit PC board (EC1)

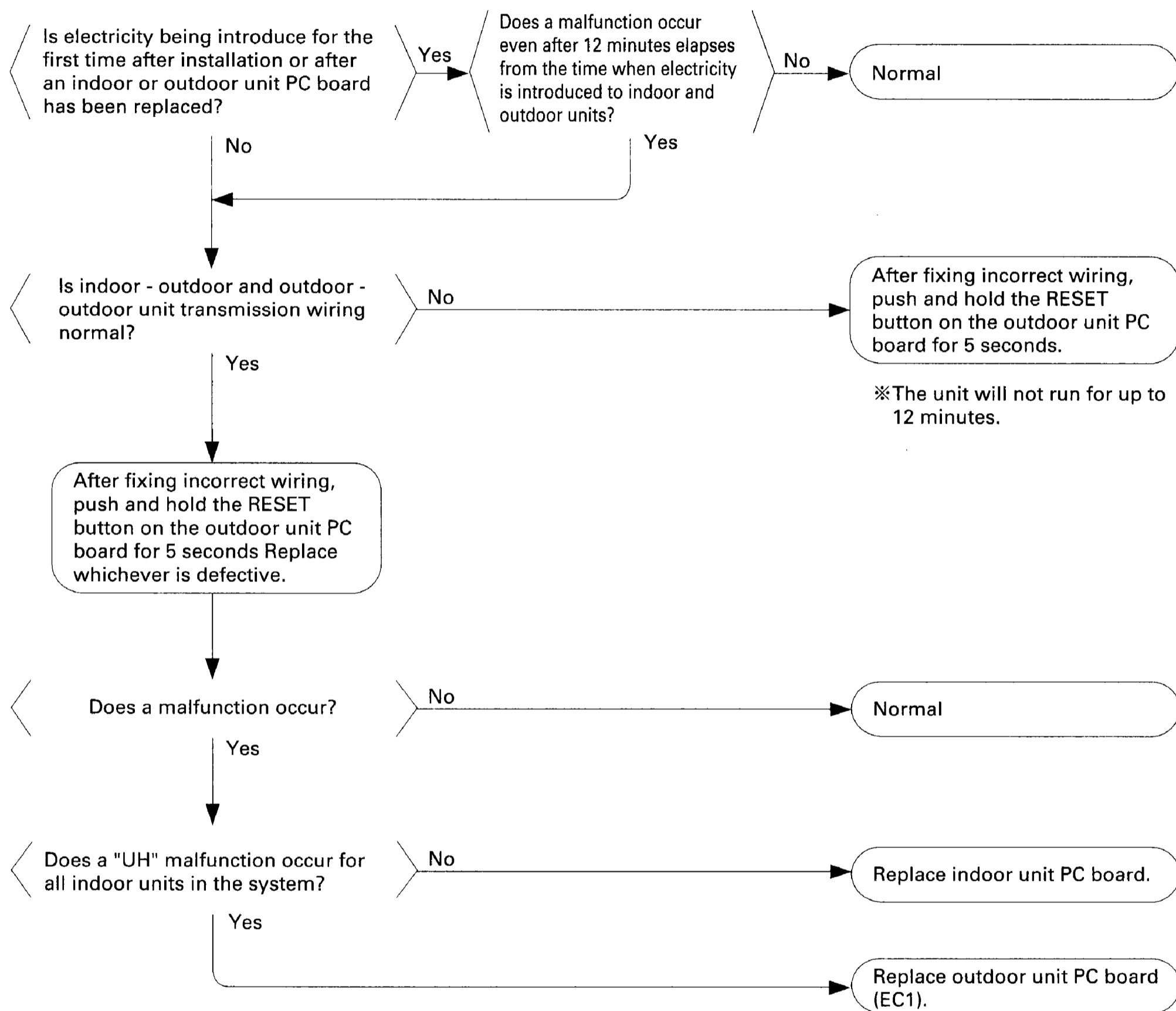

## 4. Failure Diagnosis for Inverter System

### Points of diagnosis

The main causes for each malfunction code are given in the table below. (For details refer to the next page and those following.)

- ◎ : Failure is probable
- : Failure is possible
- △ : Failure is improbable
- : Failure is impossible

Malfunction code	Contents of malfunction	Location of failure							Point of diagnosis
		Inverter		Compressor	Refrigerant system	Outdoor unit PC board	Other	Field cause	
		PC board power unit	Other						
L4	Radiator fin temperature rise	△	◎	—	—	—	—	△	Is the intake port of the radiator fin clogged?
L5	Instantaneous over-current	○	—	◎	△	—	—	—	Inspect the compressor.
L8	Electronic thermostat	△	—	◎	○	—	—	—	Inspection the compressor and refrigerant system.
L9	Stall prevention	△	—	○	◎	—	—	—	Inspection the compressor and refrigerant system.
LC	Malfunction of transmission between inverter PC board and outdoor unit PC board	○	◎	—	—	△	—	—	Inspect the connection between the inverter PC board and outdoor unit PC board. Next, inspect the inverter PC board.
U2	Insufficient current/voltage	○	○	—	—	—	△	◎	<ul style="list-style-type: none"> <li>● Inspect the fuse on the inverter PC board.</li> <li>● Check the DC voltage.</li> </ul>
P1	Over-ripple protection	○	○	—	—	—	—	○	<ul style="list-style-type: none"> <li>● Open phase</li> <li>● Current/voltage imbalance</li> <li>● Defect of main circuit wiring</li> </ul>
P4	Defect of radiator fin temperature sensor	○	△	—	—	—	—	—	Inspect the radiator fin thermistor.



## 5. How to use the Monitor switch on the Inverter PC Board

The monitor lets you know the contents of the latest stop due to malfunction by LED display on the inverter PC Board. The inverter is equipped with a retry function that retries operation each time stop due to malfunction occurs, and malfunction is therefore not ascertained by merely entering the five minutes standby while retry is attempted the prescribed number of times. If the number of retry times is exceeded within 60 minutes, malfunction is ascertained, and the corresponding malfunction code is displayed on the indoor unit remote controller.

LED	A	1	2	3	4	Malfunction contents	Retry times
	◐	●	●	●	●	Normal	
	◐	●	●	●	○	Malfunction of fin thermistor	3
	◐	○	○	●	●	Sensor malfunction	0
	◐	○	●	●	○	Insufficient voltage	3
	◐	●	●	○	●	Instantaneous over-current	3
	◐	●	○	○	○	Electronic thermistor	3
	◐	○	○	○	○	Stall prevention	3
	◐	●	○	●	●	Open phase detection	3
	●	●	●	●	●	Malfunction of microcomputer	Unlimited

- ◐ : Blink
- : On
- : Off

## Remote controller display

### Malfunction code "L4" blinks.

#### Cause of malfunction

(1) Actuation of fin thermal (Actuates at min. 90°C and resets at max. 80°C)

(2) Defect of inverter PC board

(3) Defect of fin thermistor

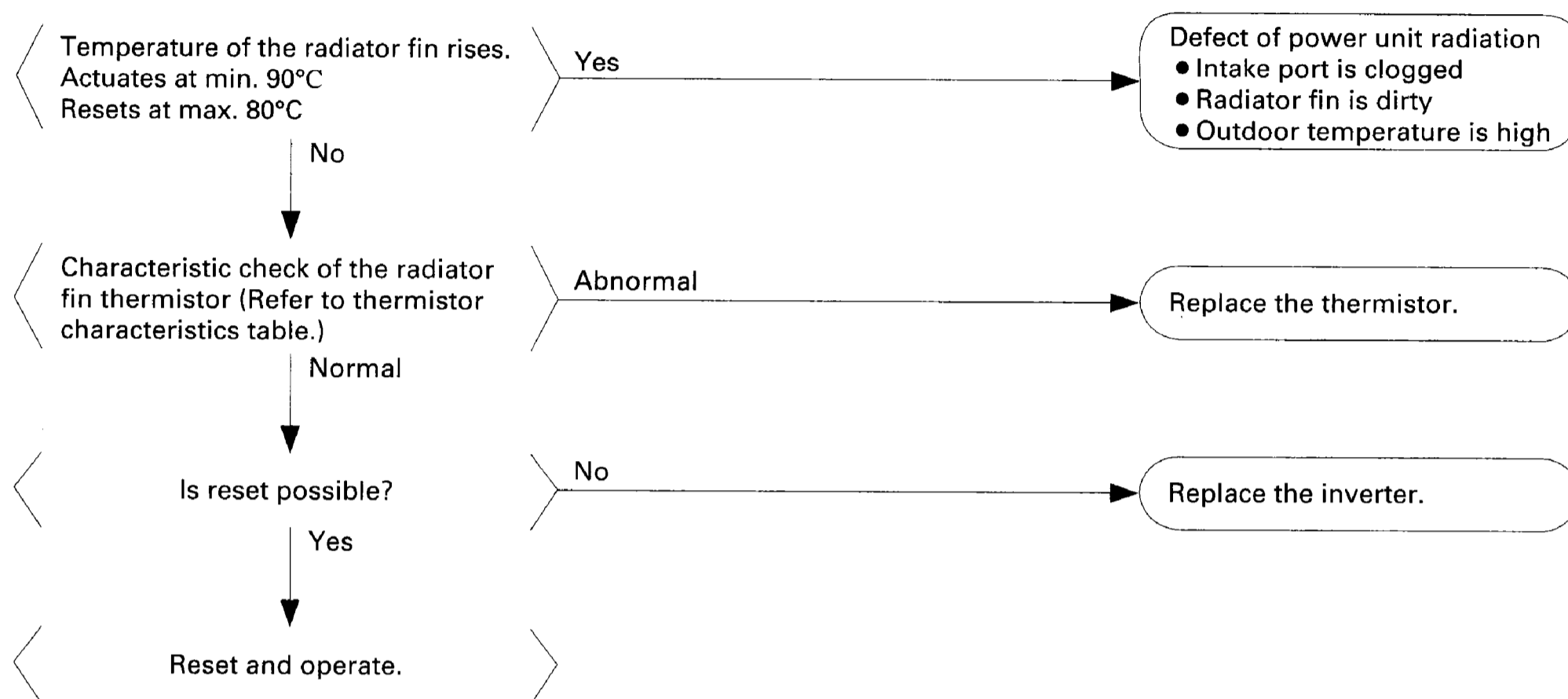

## Remote controller display

### Malfunction code "L5" blinks.

#### Cause of malfunction

- (1) Defect of compressor coil (disconnected, defective insulation)
- (2) Compressor start-up malfunction (mechanical lock)
- (3) Defect of inverter unit

#### Compressor inspection

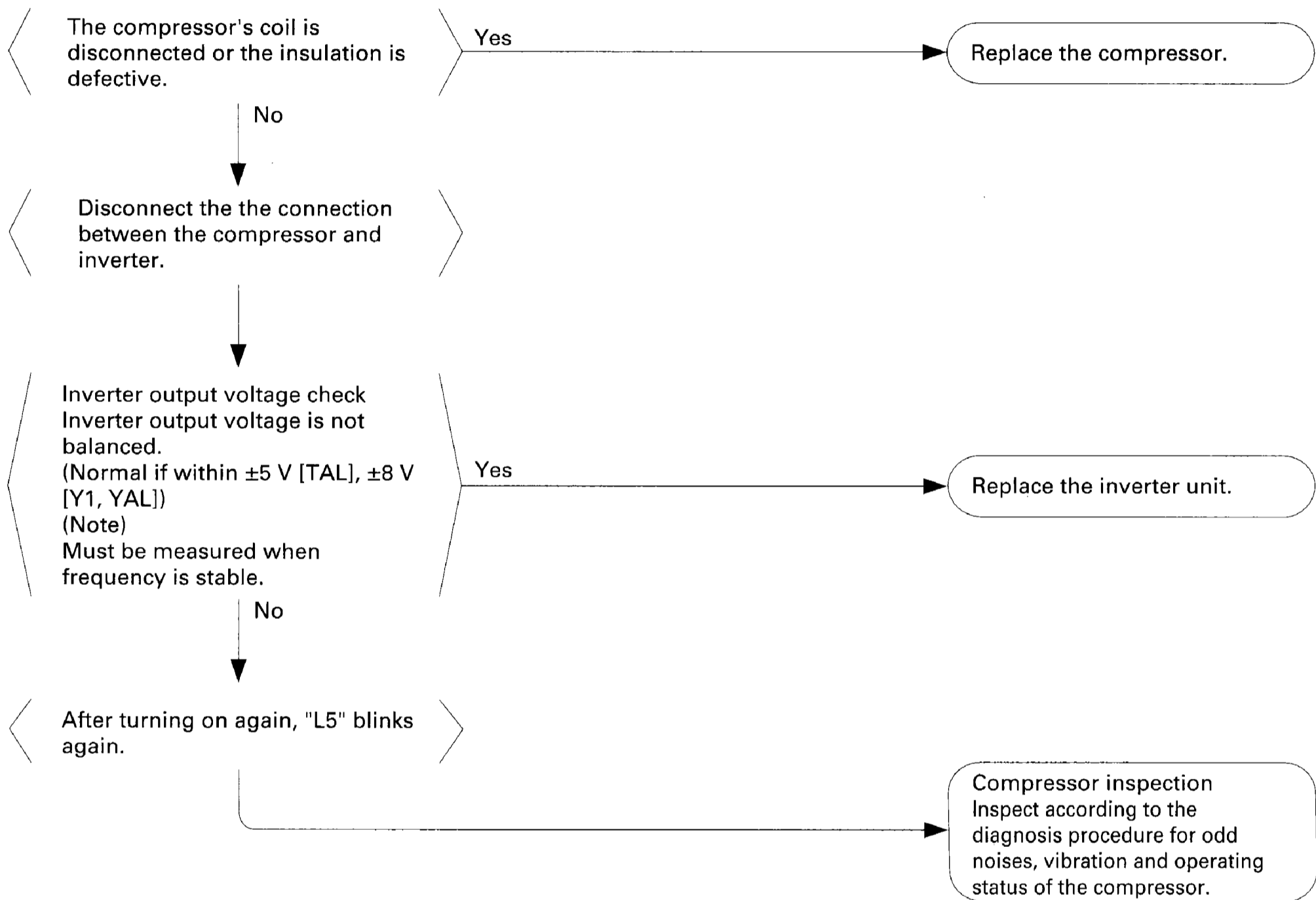

## Remote controller display

### Malfunction code "L8" blinks.

#### Cause of malfunction

- (1) Compressor overload
- (2) Compressor coil disconnected
- (3) Defect of inverter unit

#### Output current check

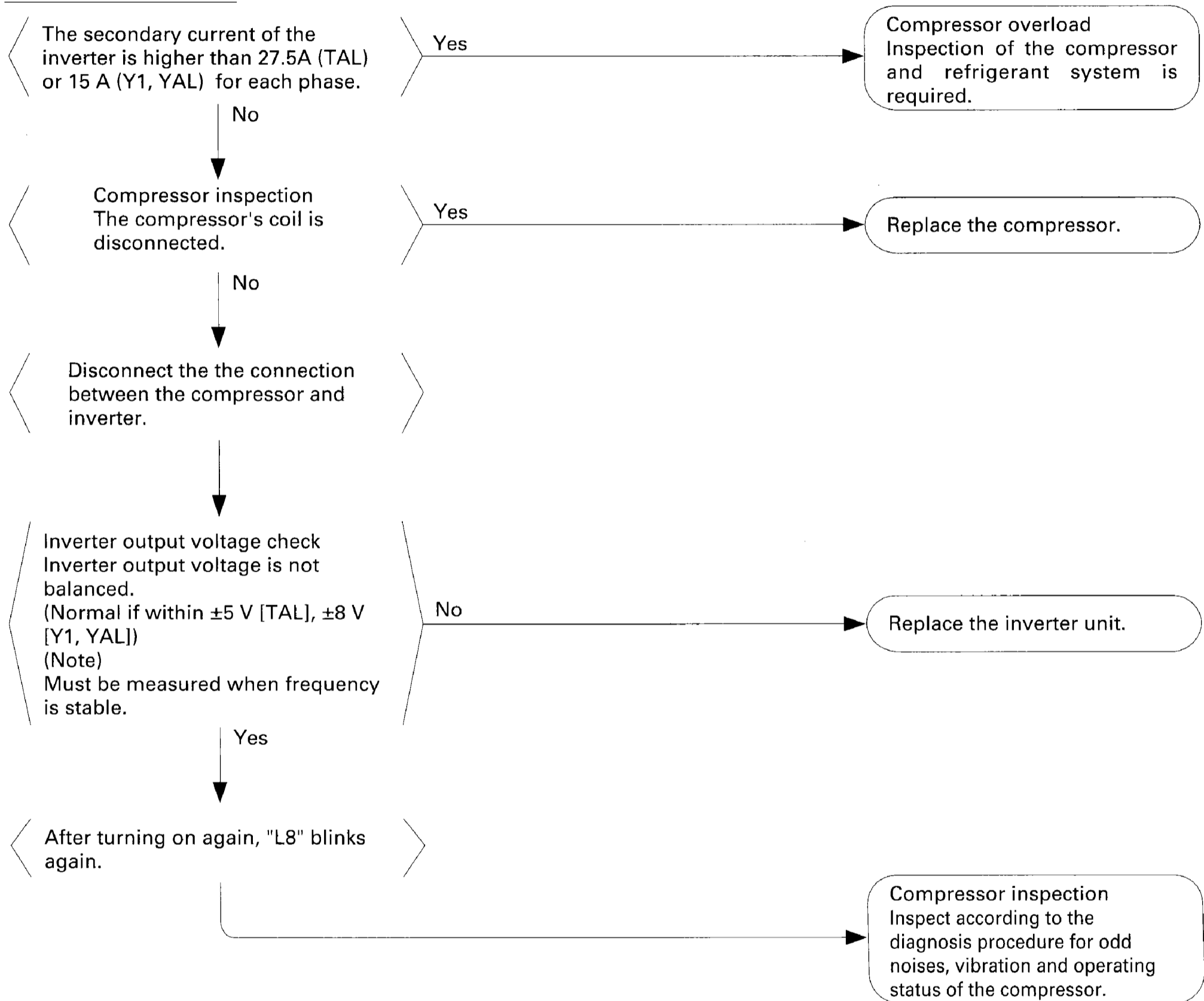

## Remote controller display

### Malfunction code "L9" blinks.

#### Cause of malfunction

- (1) Defect of compressor
- (2) Pressure differential start
- (3) Defect of inverter unit

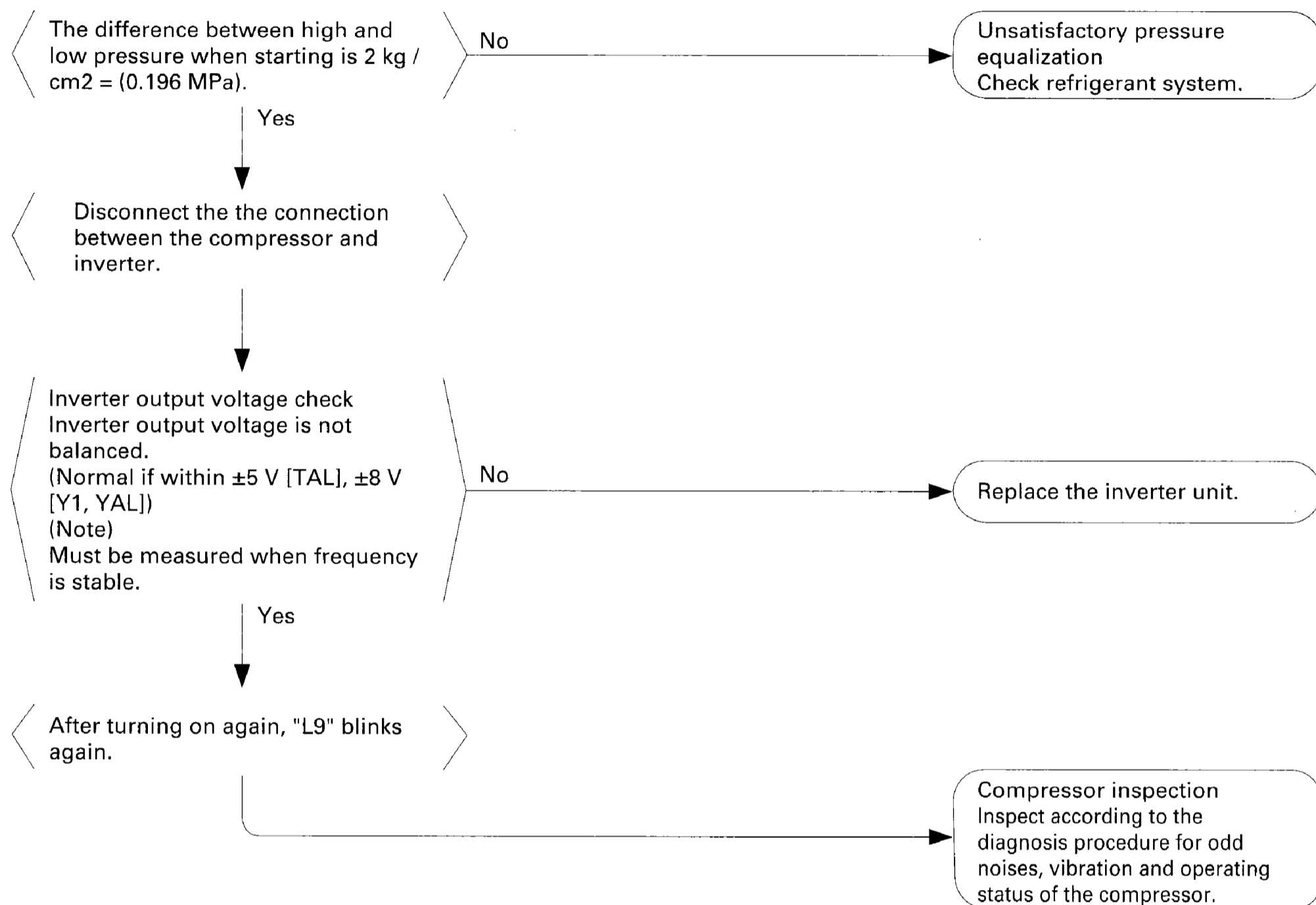

## Remote controller display

### Malfunction code "LC" blinks.

#### Cause of malfunction

- (1) Malfunction of connection between the inverter unit and outdoor unit PC board
- (2) Defect of outdoor unit PC board (transmission section)
- (3) Defect of inverter unit
- (4) Defect of noise filter (NF1)

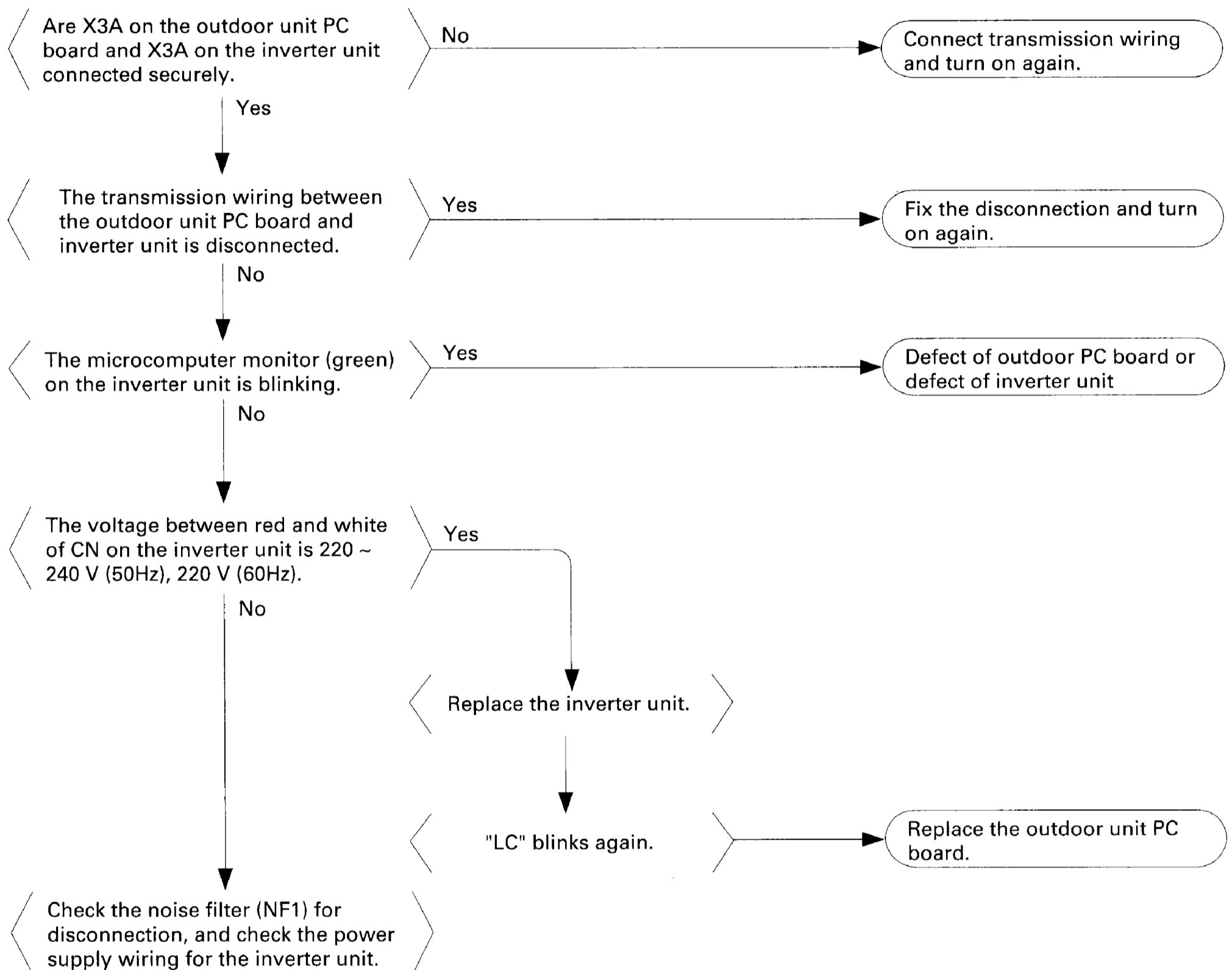

## Remote controller display

### Malfunction code "U2" blinks.

#### Cause of malfunction

- (1) Power supply insufficient
- (2) Instantaneous failure
- (3) Open phase
- (4) Defect of inverter unit
- (5) Defect of outdoor PC board
- (6) Defect of K1M.
- (7) Main circuit wiring defect

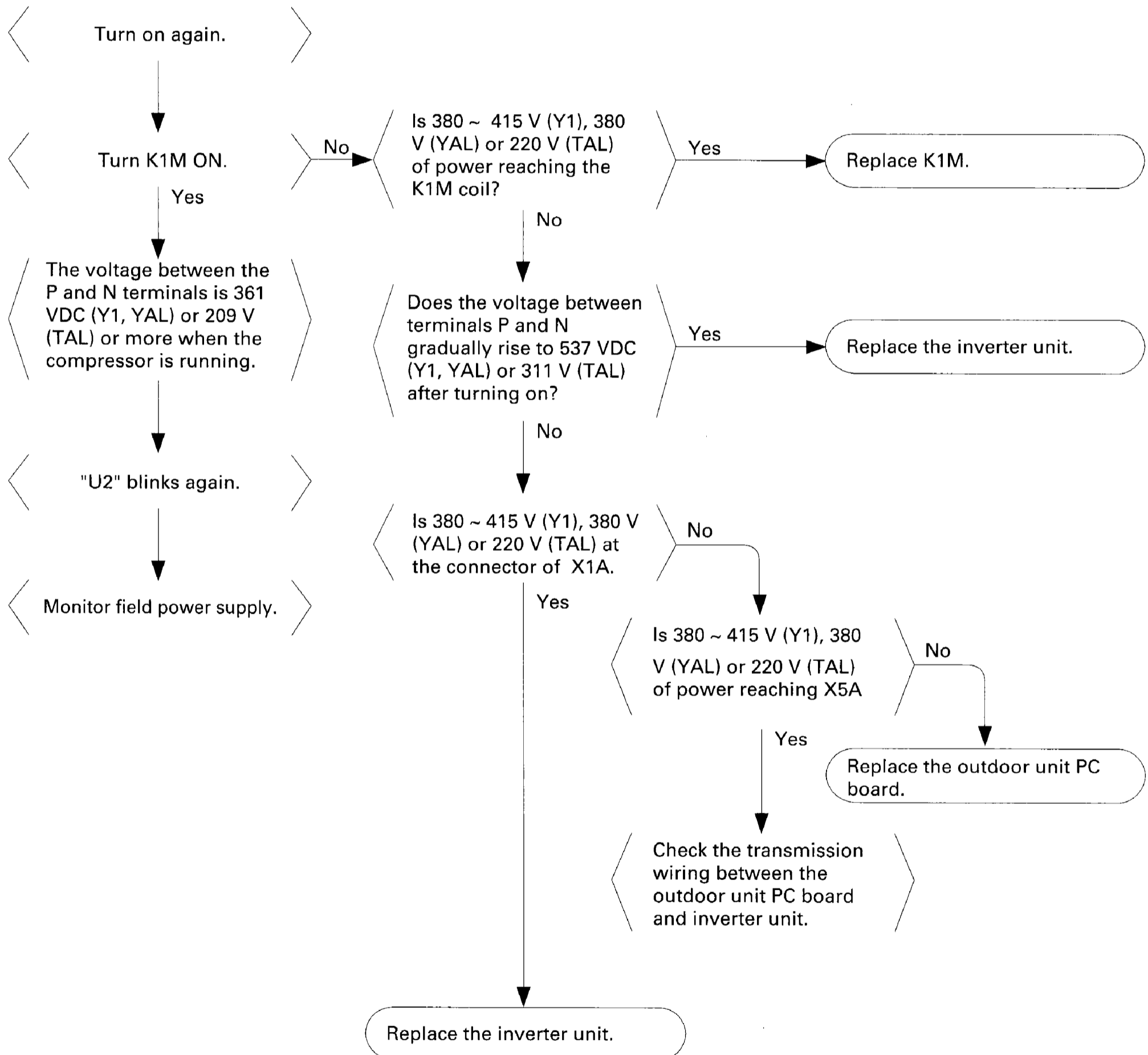

## Remote controller display

### Malfunction code "P1" blinks.

#### Cause of malfunction

- (1) Open phase
- (2) Voltage imbalance between phases
- (3) Defect of main circuit capacitor
- (4) Defect of inverter unit
- (5) Defect of K1M
- (6) Improper main circuit wiring

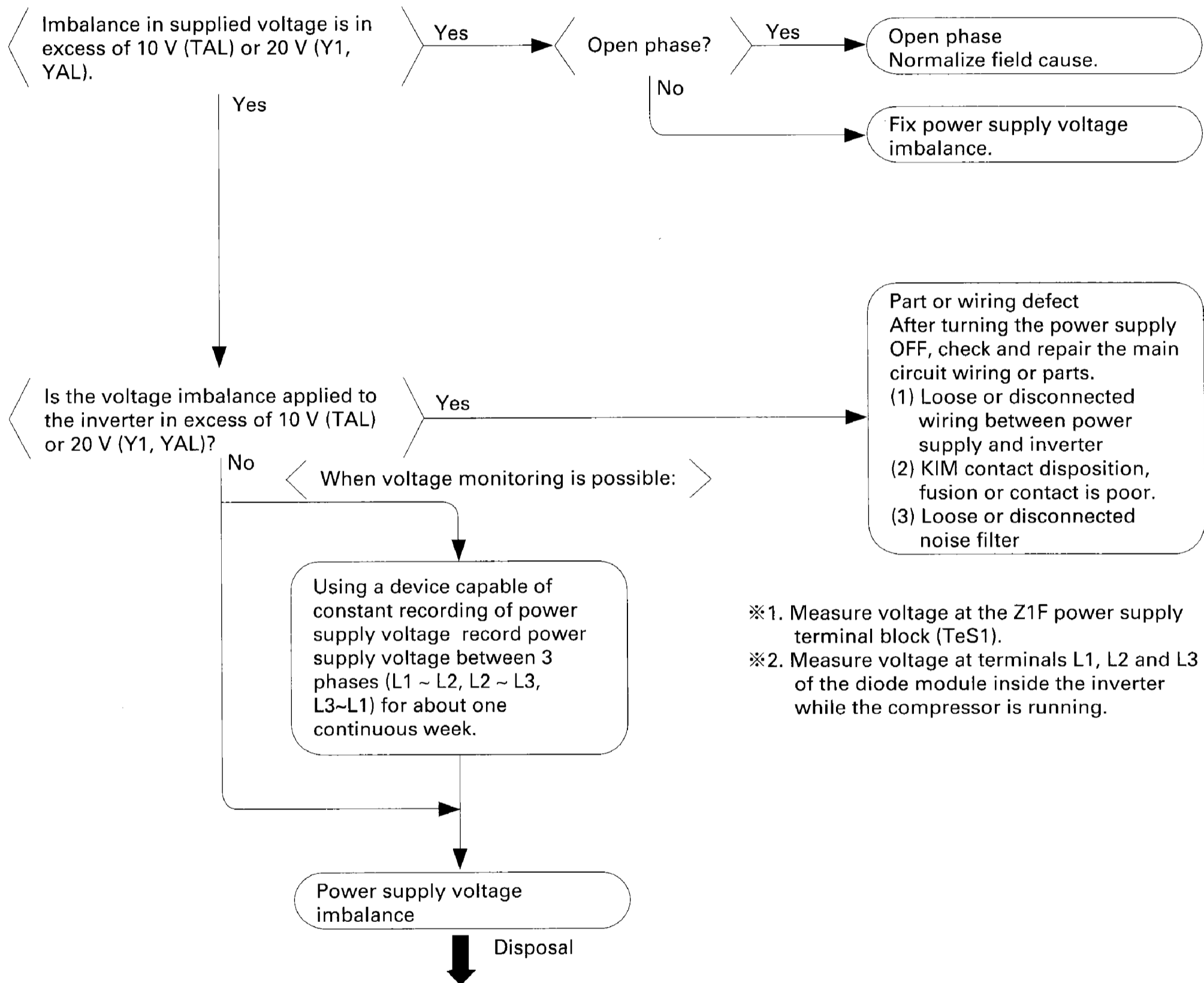

- ※1. Measure voltage at the Z1F power supply terminal block (TeS1).
- ※2. Measure voltage at terminals L1, L2 and L3 of the diode module inside the inverter while the compressor is running.

#### Explanation for users

※In accordance with "notification of inspection results" accompanying spare parts.

Give the user a copy of "notification of inspection results" and leave it up to him to improve the imbalance.

Be sure to explain to the user that there is a "power supply imbalance" for which DAIKIN is not responsible.

Contact QC div.

Be sure to send a product report of the imbalance.



## Remote controller display

### Malfunction code "P4" blinks.

#### Cause of malfunction

- (1) Defect of radiator fin temperature sensor
- (2) Defect of inverter unit

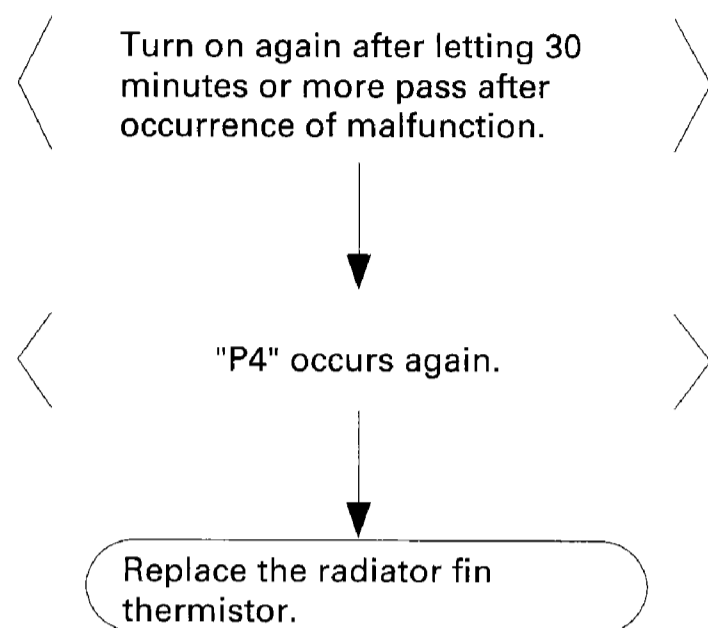

## 6. Failure Diagnosis for Central Remote Controller (1/4)

### Malfunction 1: Liquid crystal operation monitor and "UE" blink.

#### Cause of malfunction

- (1) Malfunction of transmission between optional controllers for centralized control and indoor unit
- (2) Connector for setting master controller is disconnected.
- (3) Failure of PC board for central remote controller
- (4) Defect of indoor unit PC board

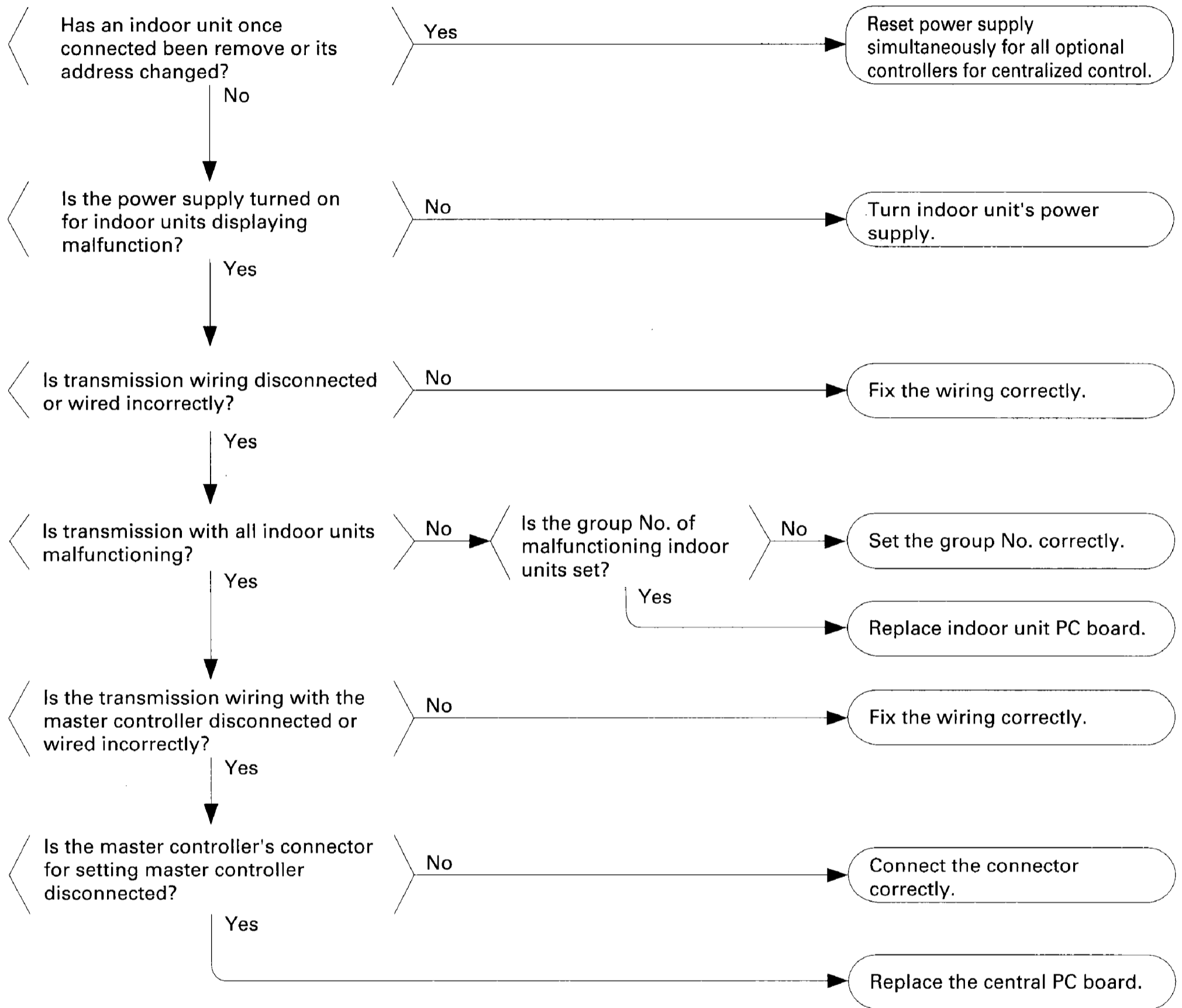

## Failure Diagnosis for Central Remote Controller (2/4)

### Malfunction 2: Malfunction code "M1" blinks

#### Cause of malfunction

- (1) Defect of central remote controller PC board

Replace the central remote controller PC board.

### Malfunction 3: Malfunction code "M8" blinks.

#### Cause of malfunction

- (1) Malfunction of transmission between optional controllers for centralized control
- (2) Defect of PC board of optional controllers for centralized control

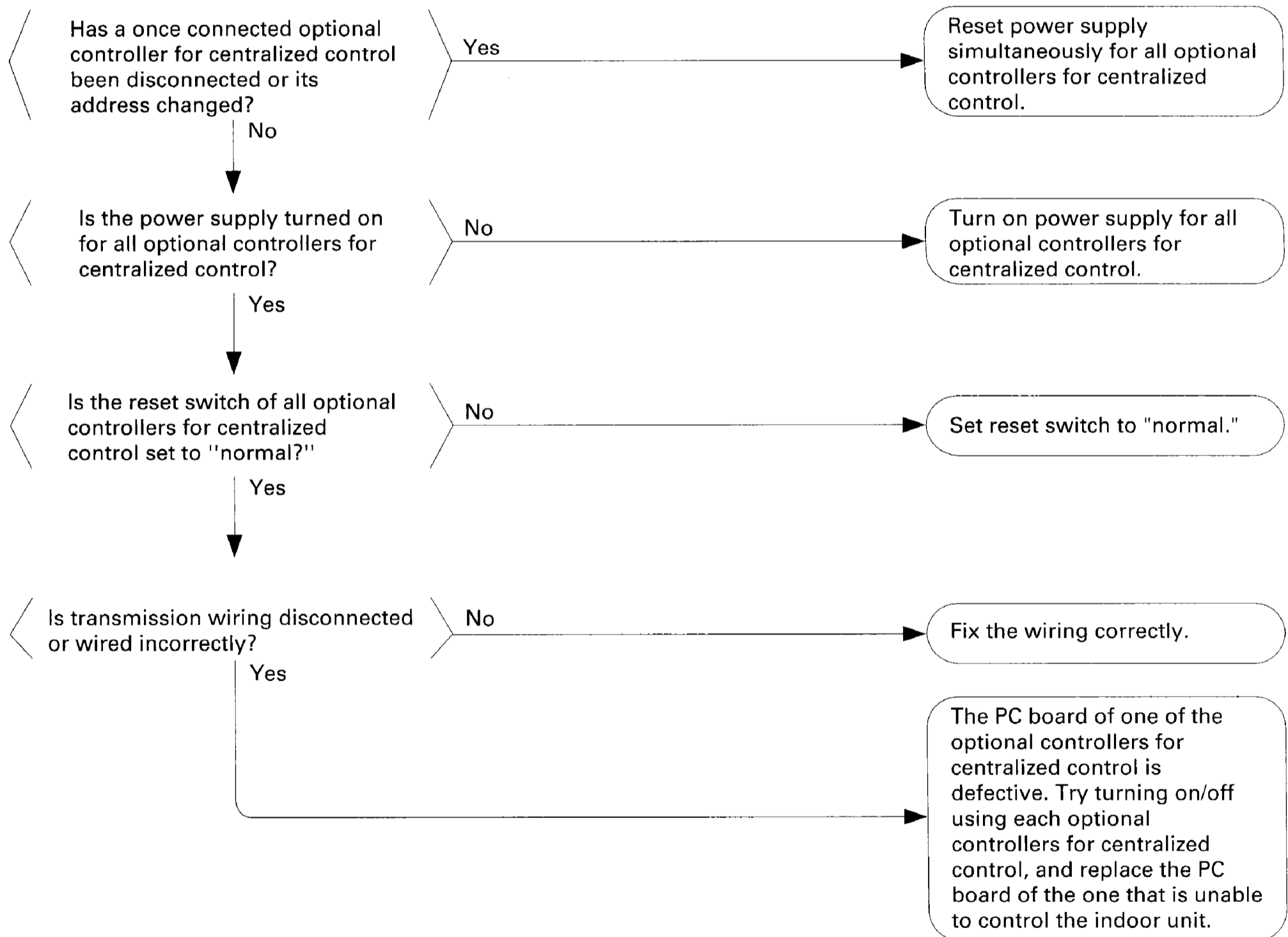

## Failure Diagnosis for Central Remote Controller (3/4)

### Malfunction 4: Malfunction code "MA" blinks.

#### Cause of malfunction

- (1) Improper combination of optional controllers for centralized control
- (2) More than one master controller is connected
- (3) Defect of PC board of optional controller for centralized control

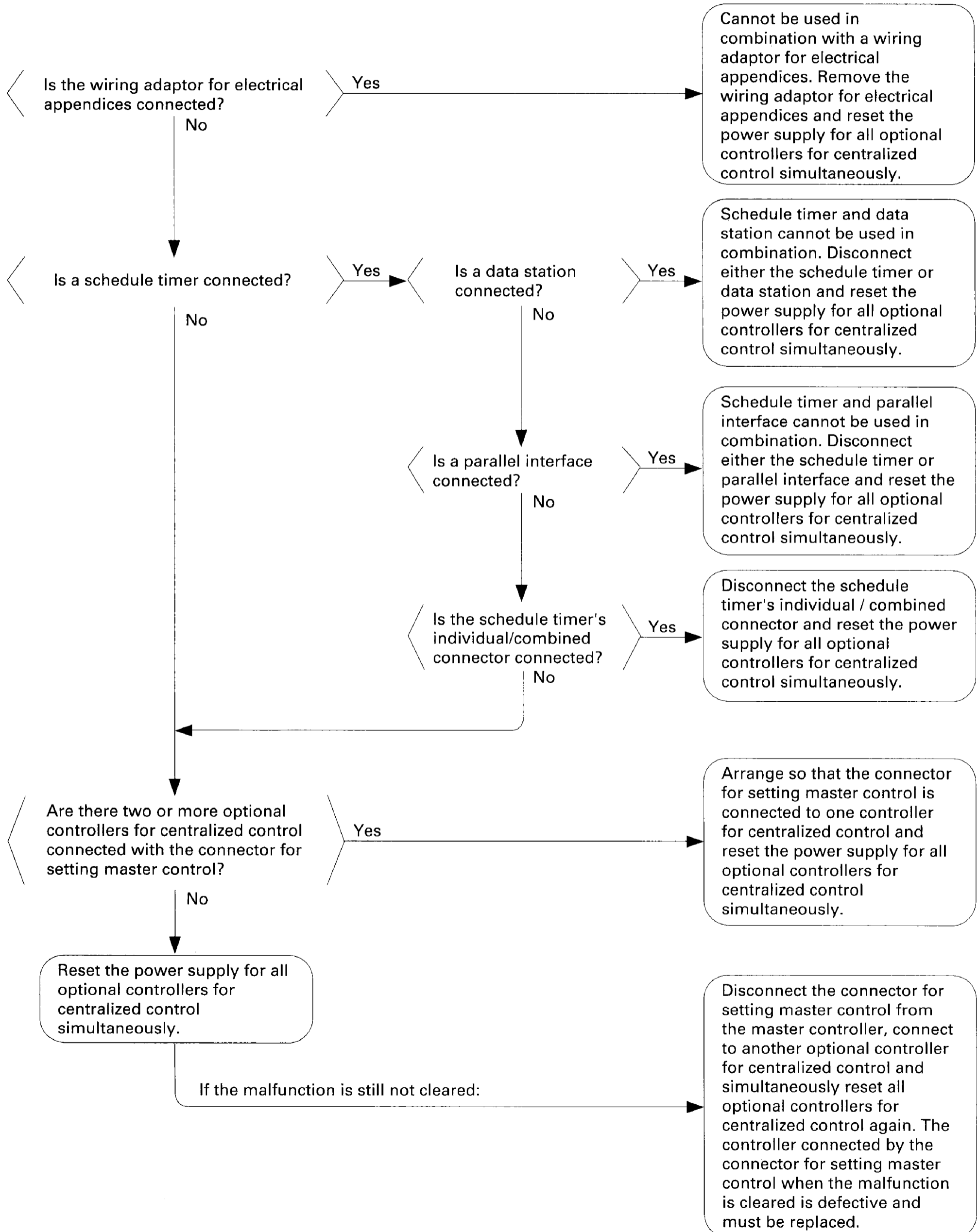

## Failure Diagnosis for Central Remote Controller (4/4)

### Malfunction 5: Malfunction code "MC" blinks.

Cause of malfunction

(1) Address duplication of central remote controller

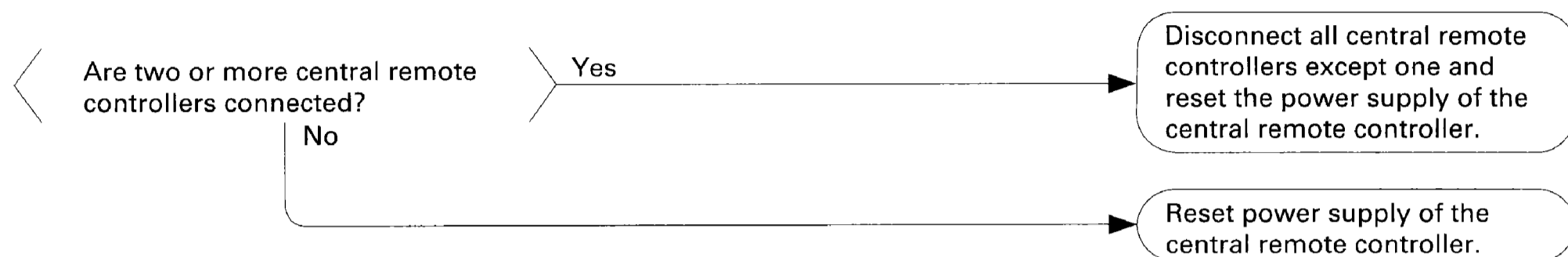

## 7. Failure Diagnosis for Schedule Timer (1/4)

### Malfunction 1: Operation lamp and "UE" blinks.

#### Cause of malfunction

- (1) Malfunction of transmission between central remote controller and indoor unit
- (2) Disconnection of connector for setting master controller (or individual/combined switching connector)
- (3) Defect of schedule timer PC board
- (4) Defect of indoor unit PC board

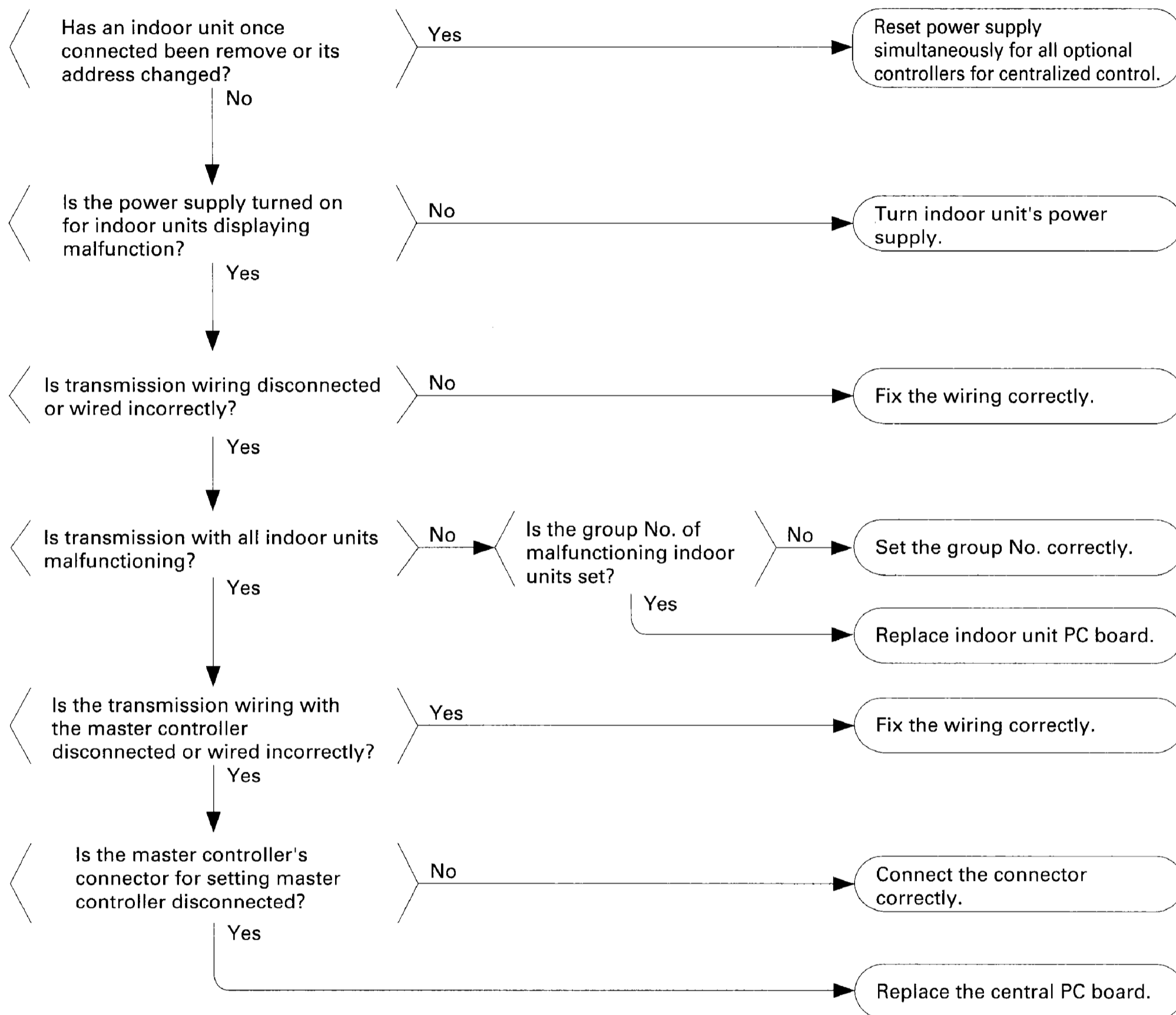

## Failure Diagnosis for Schedule Timer (2/4)

### Malfunction 2: Operation lamp and "M1" blinks.

Cause of malfunction

(1) Defect of schedule timer PC board

Replace the schedule timer PC board.

### Malfunction 3: Malfunction code "M8" blinks.

Cause of malfunction

(1) Malfunction of transmission between optional controllers for centralized control

(2) Defect of PC board of optional controllers for centralized control

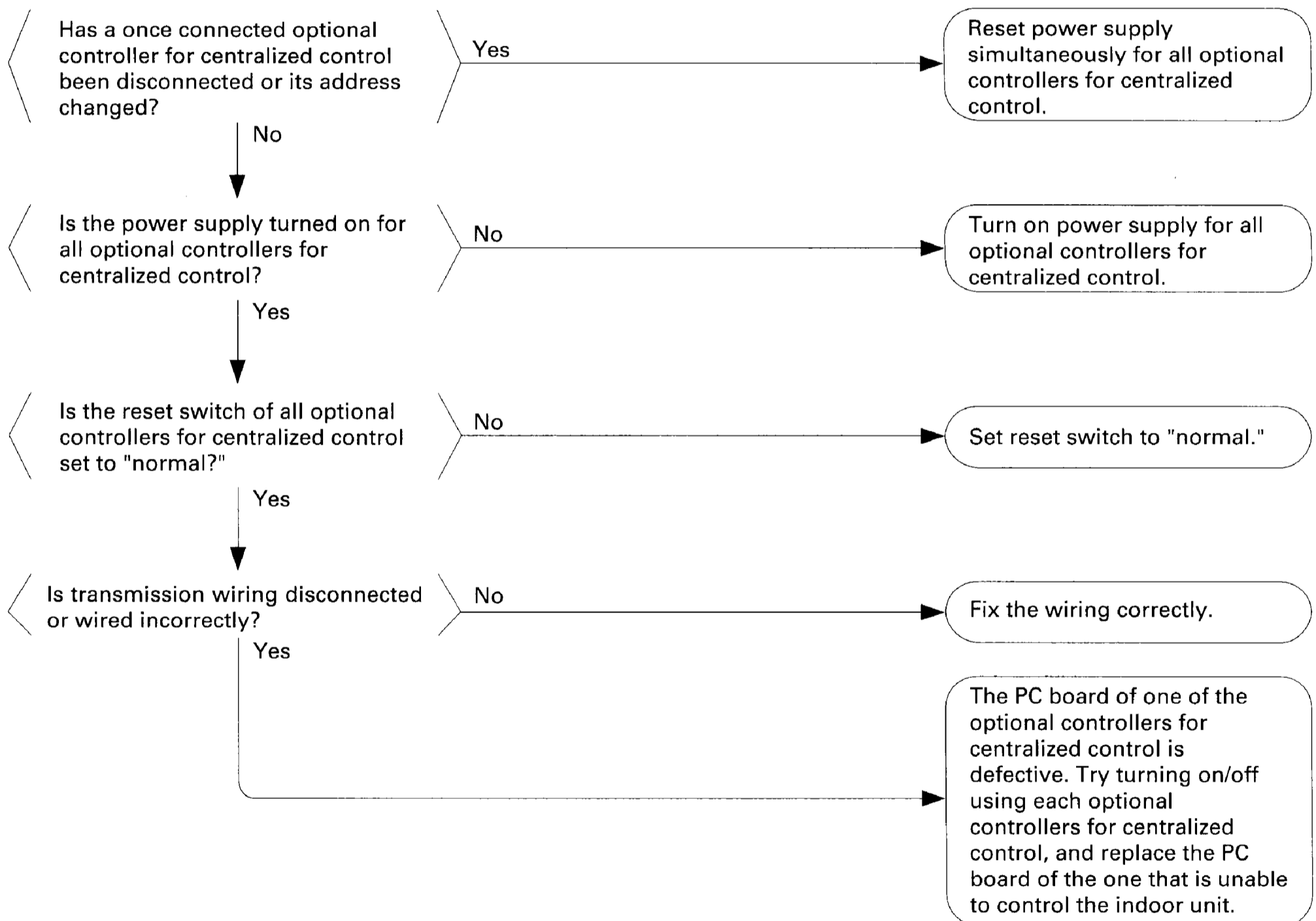

## Failure Diagnosis for Schedule Timer (3/4)

### Malfunction 4: Malfunction code "MA" blinks.

#### Cause of malfunction

- (1) Improper combination of optional controllers for centralized control
- (2) More than one master controller is connected.
- (3) Defect of PC board of optional controller for centralized control

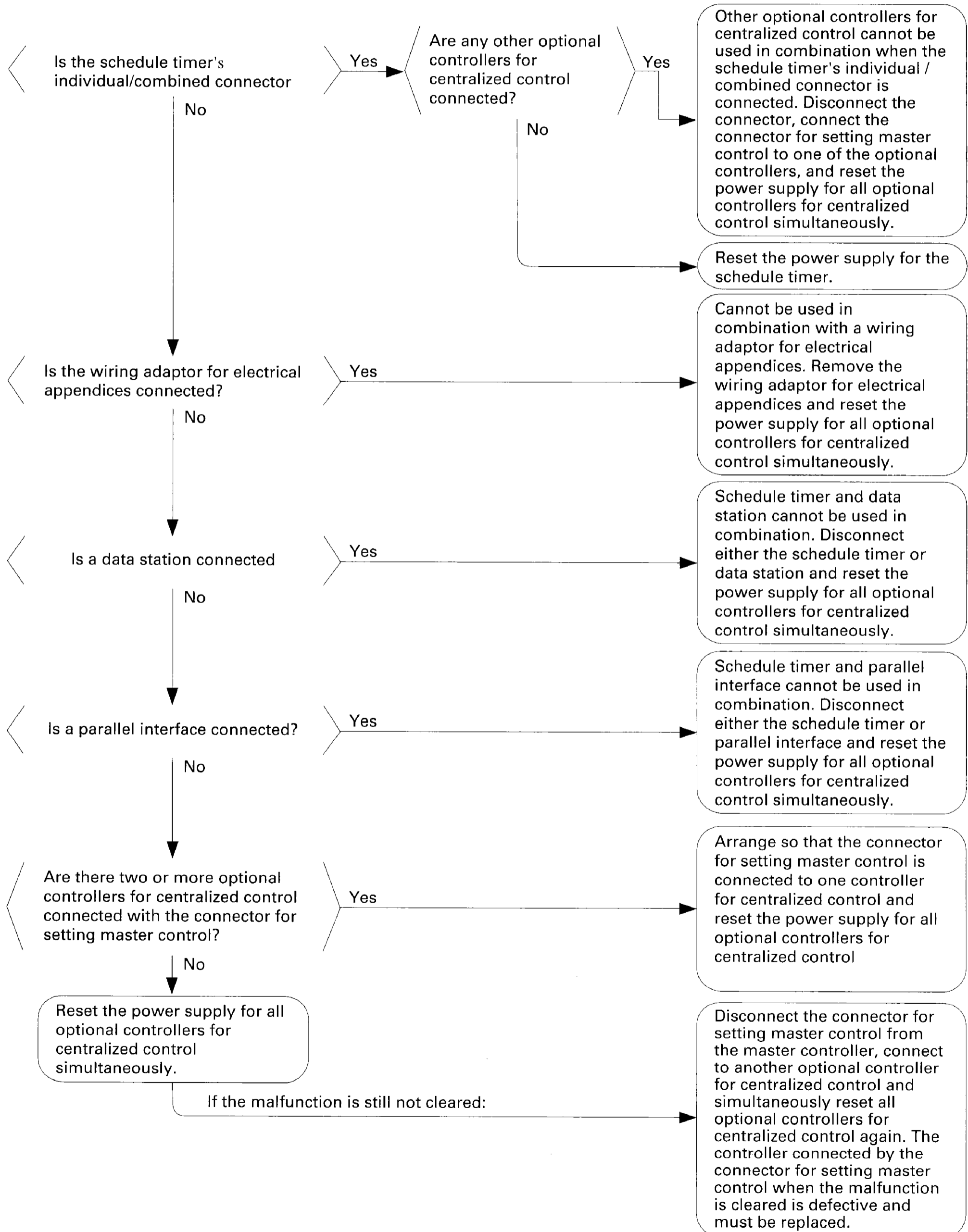



## Failure Diagnosis for Schedule Timer (4/4)

### Malfunction 4: Malfunction code "MC" blinks.

Cause of malfunction

(1) Address duplication of optional controller for centralized control

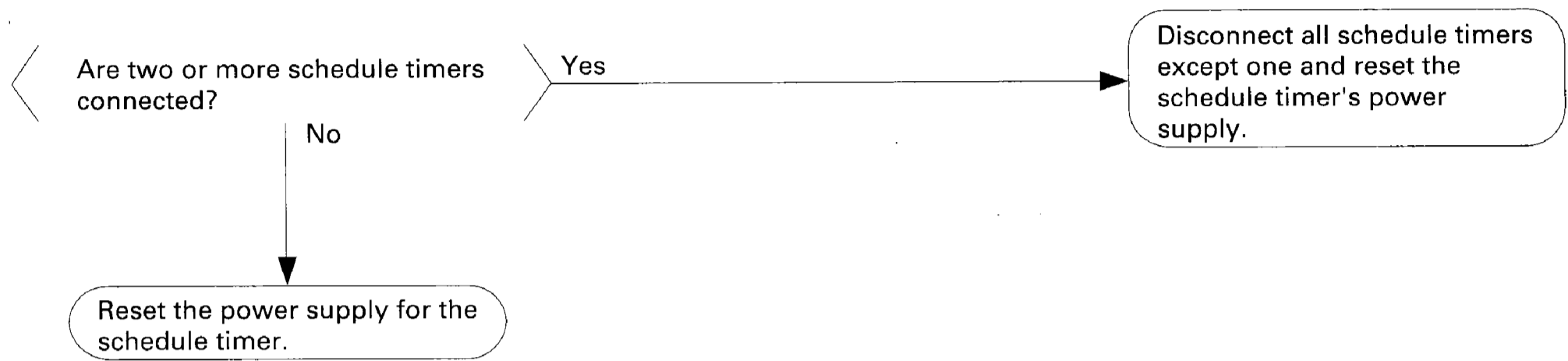

## 8. Failure Diagnosis for Unified ON/OFF Controller (1/3)

### Malfunction 1: Operation lamp blinks

#### Cause of malfunction

- (1) Malfunction of transmission between optional controller and indoor unit
- (2) Connector for setting master controller is disconnected
- (3) Defect of unified ON/OFF controller
- (4) Defect of indoor unit PC board
- (5) Malfunction of air conditioner

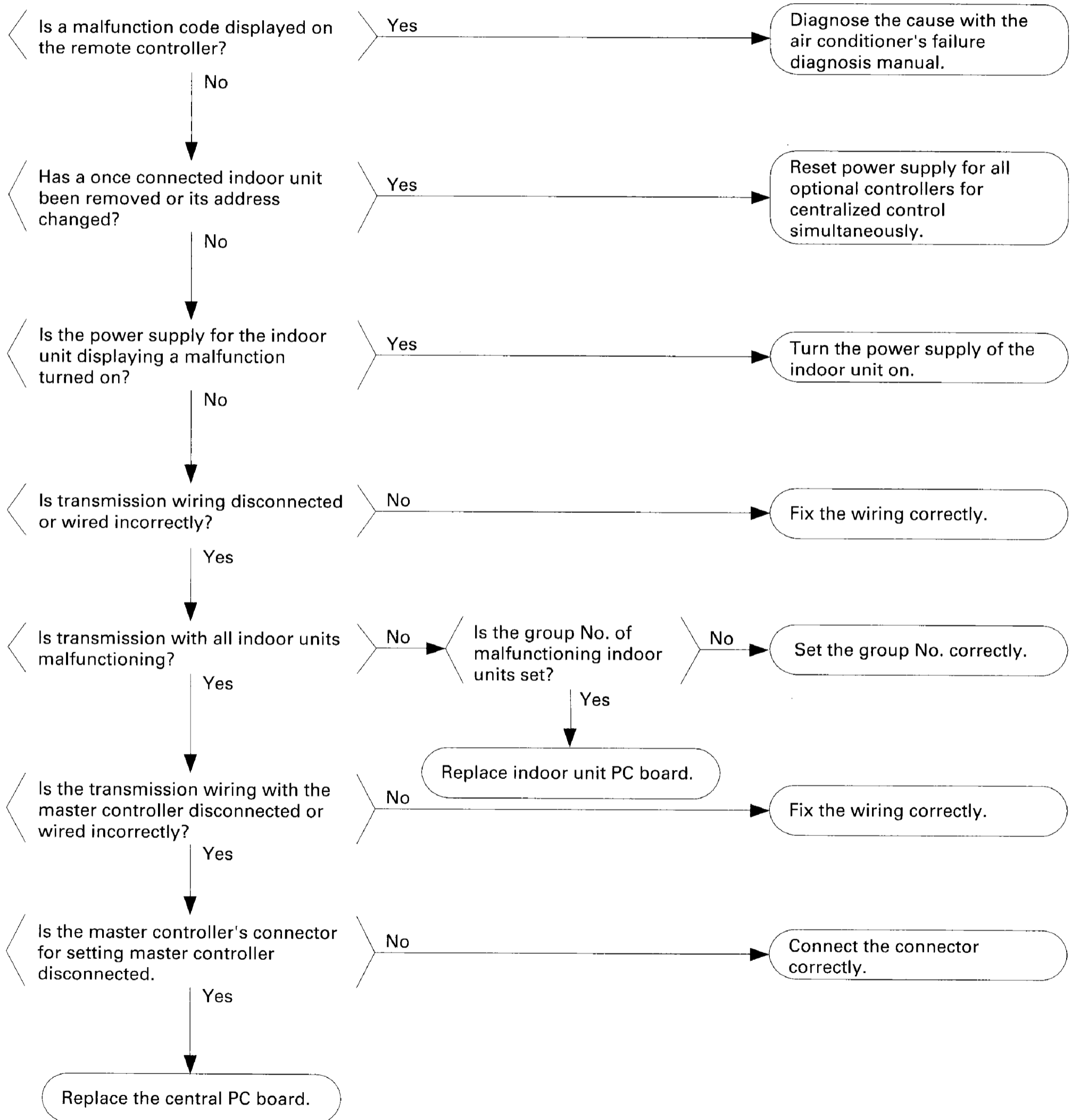

## Failure Diagnosis for Unified ON/OFF Controller (2/3)

### Malfunction 2: Display "under host computer integrated control" blinks (Repeats single blink)

#### Cause of malfunction

- (1) Address duplication of central remote controller
- (2) Improper combination of optional controllers for centralized control
- (3) Connection of more than one master controller
- (4) Malfunction of transmission between optional controllers for centralized control
- (5) Defect of PC board of optional controllers for centralized control

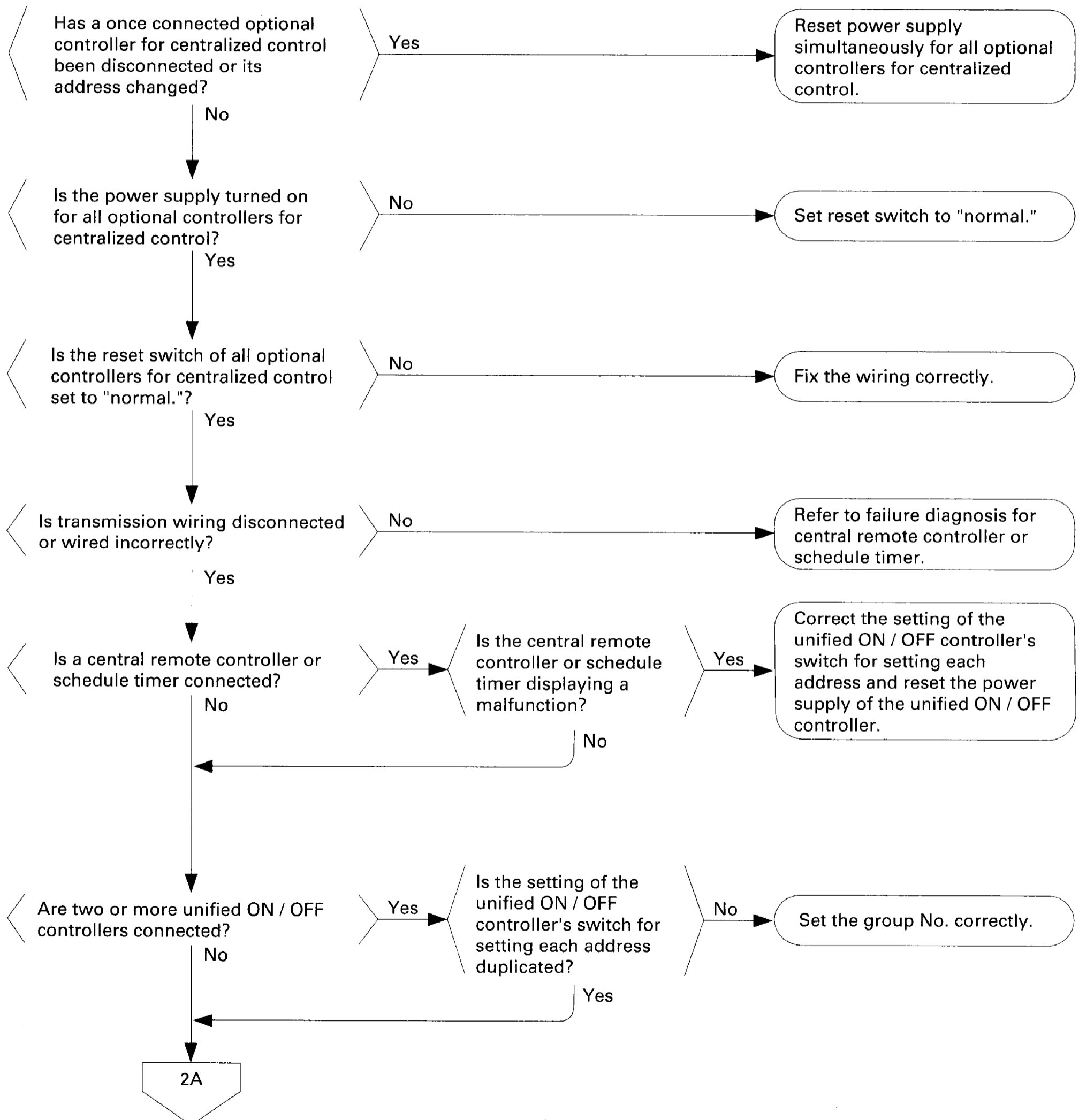

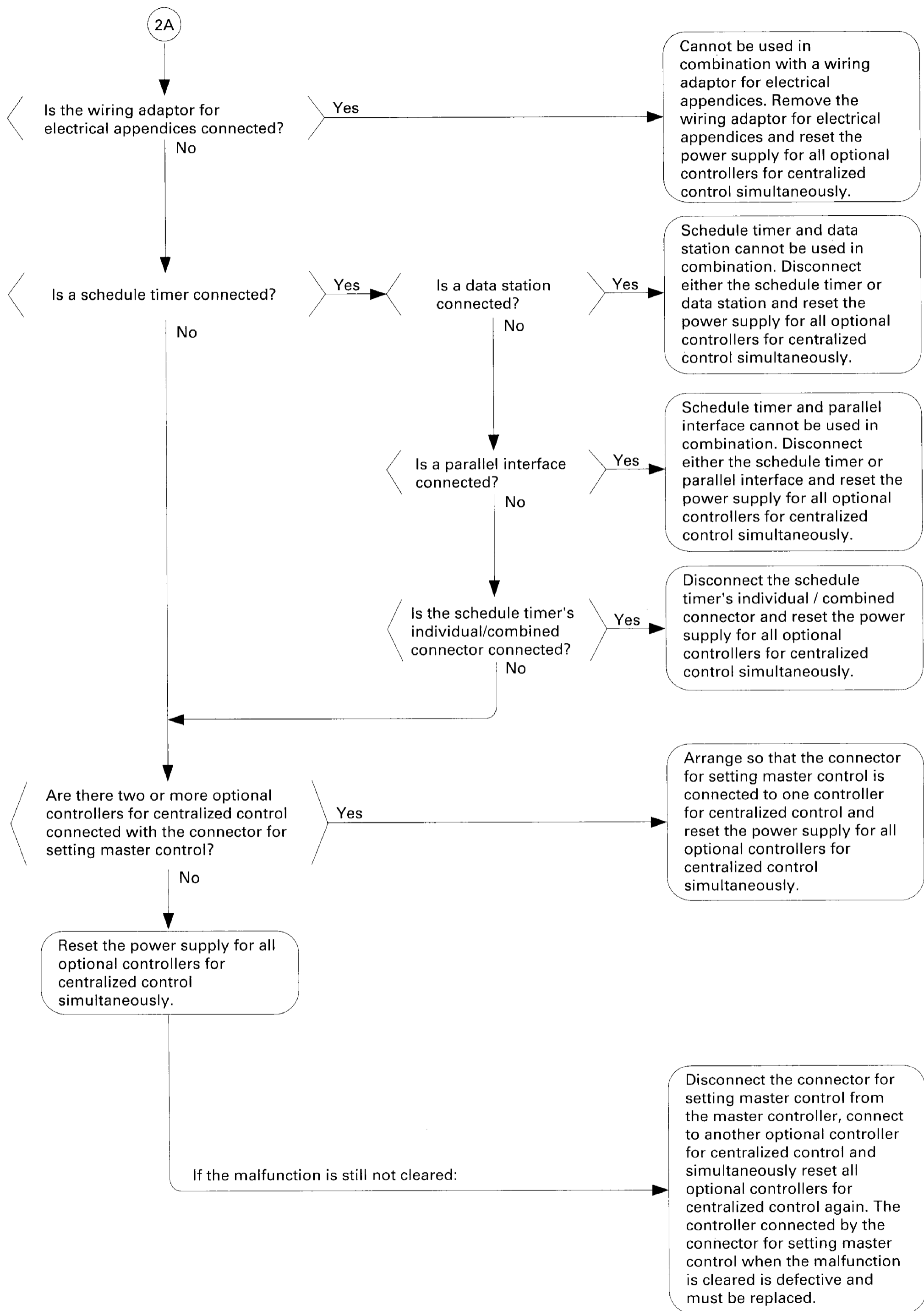

## Failure Diagnosis for Unified ON/OFF Controller (3/3)

### Malfunction 3: Display "under host computer integrated control" blinks (Repeats double blink)

Cause of malfunction

- (1) Central control address (group No.) is not set for indoor unit.
- (2) Improper address setting
- (3) Improper wiring of transmission wiring

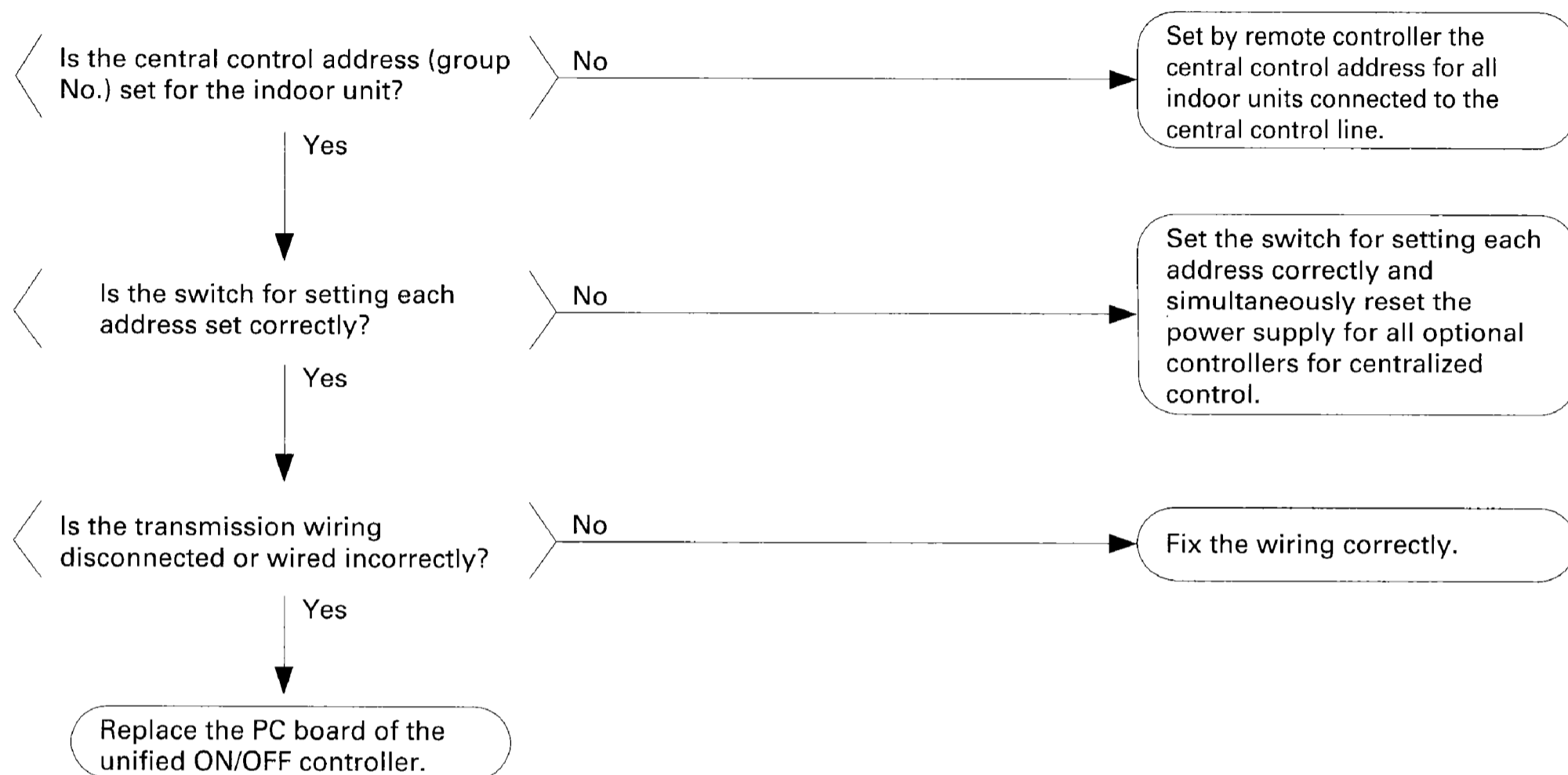

## 9. Appendix

### (1) Precautions When Replacing K Series PC Boards

If you replace the indoor or outside unit PC board, push and hold the RESET button on the outdoor unit PC Board for 5 seconds.

#### ■ In this case, the unit will not run for up to 12 minutes.

Precautions when replacing indoor unit PC board

When replacing the indoor unit PC board, the following contents are factory set. Change the settings if necessary.

1. Field set contents (dirty filter, stop input from outside, etc.)

- Change settings with the remote controller.
- When using group control or setting by individual indoor units, the "indoor unit No." before and after changing the PC board may differ.

Set after checking the indoor unit No.

2. Central address

Change setting with the remote controller.

3. Capacity display

A capacity setting adaptor must be installed for all models.

※Fan phase control is for FXYF, FXYH, FXYA only.

#### ■ Precautions when replacing outdoor unit PC board

When replacing the outdoor unit PC board, set the following settings again.

1. Field set contents (setting mode 1)

Set cool/heat selection, low noise and sequential start again.

2. Setting mode 2

Change the TC setting, TE setting and defrost setting as required.

### (2) Precautions Concerning the Remote Controller's Mode No.

Mode numbers that are not in the list but can be set may be displayed by the remote controller. Do not change settings not included in the list. If so, we may not be able to guarantee operation.

### (3) Typical Wiring Mistakes

(1) One of the indoor units is connected to outdoor-to-outdoor transmission terminals

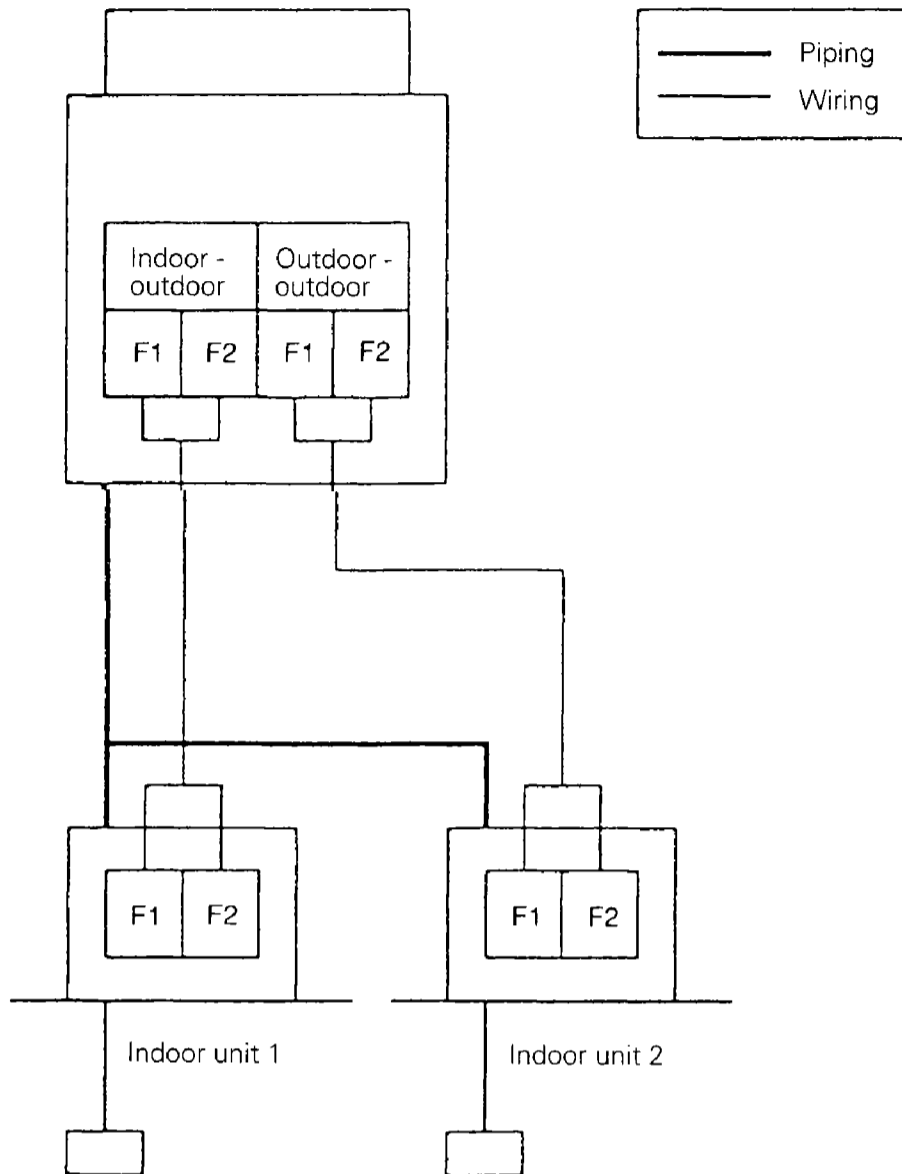

Installation / test operation

Indoor unit 1	Normal
Indoor unit 2	UF malfunction

Other

Indoor unit 1	Normal
Indoor unit 2	U4 malfunction or no malfunction display

(2) All indoor units connected to the outdoor-to-outdoor unit terminal

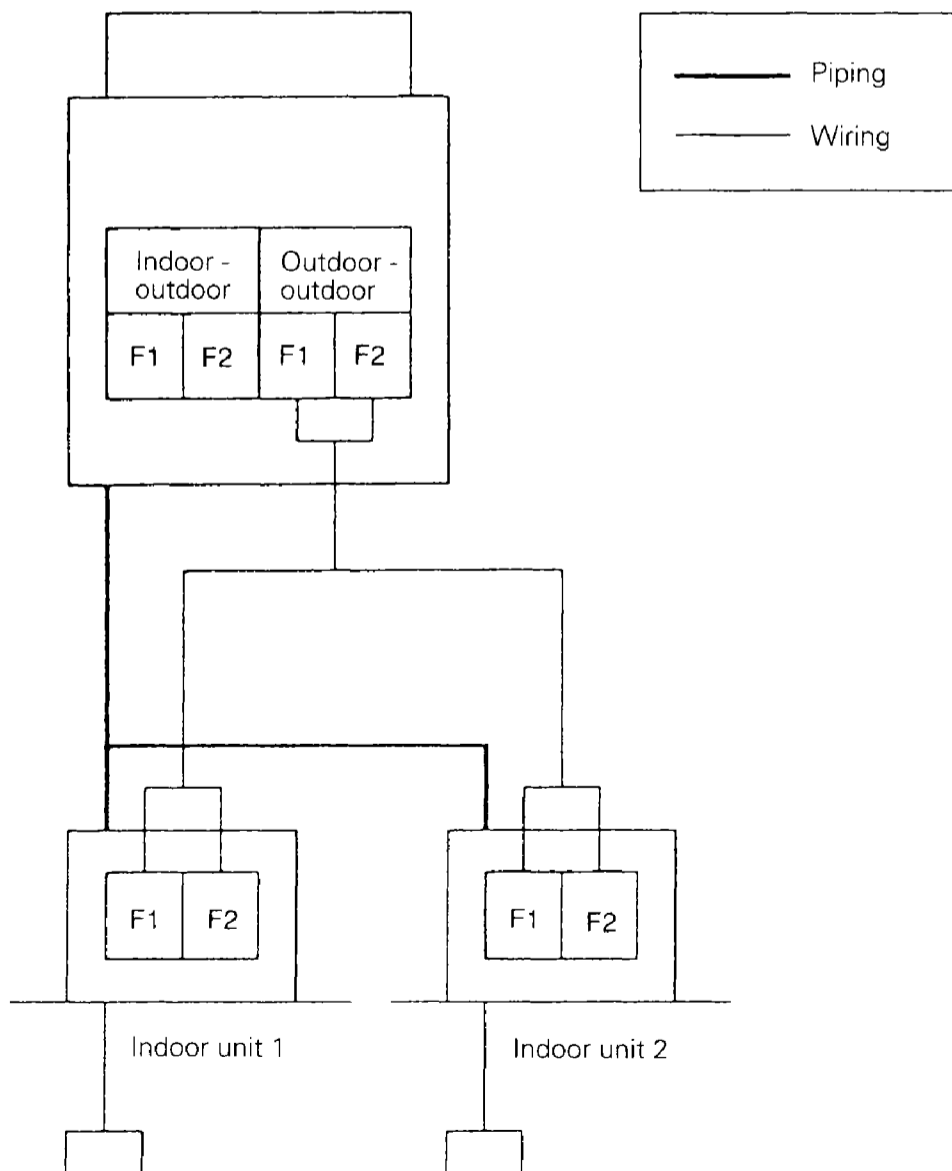

Installation / test operation

Indoor unit 1	UF malfunction
Indoor unit 2	

Other

Indoor unit 1	U4 malfunction or no malfunction display
Indoor unit 2	

(3) All indoor units connected to Indoor-to-outdoor and outdoor-to-outdoor unit terminals

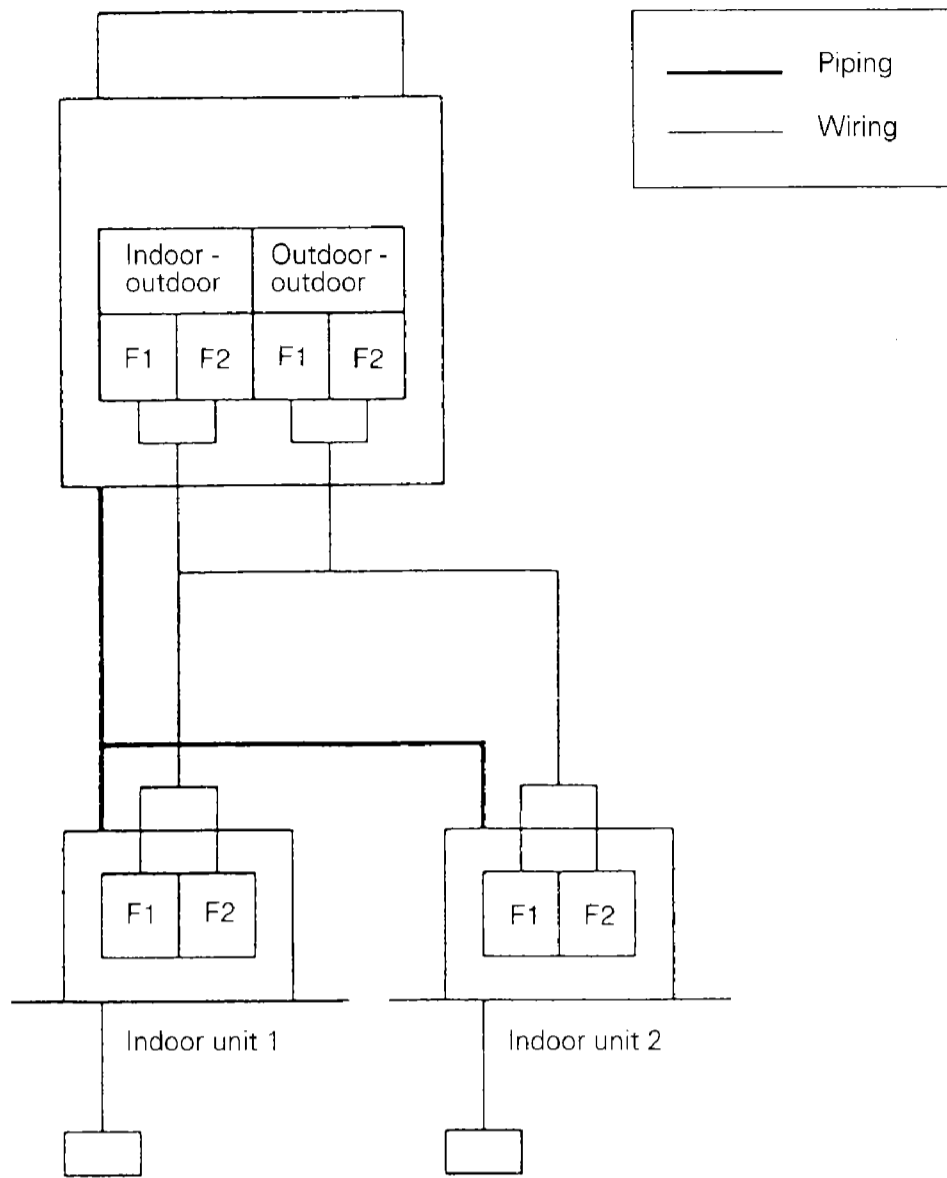

Installation / test operation

Indoor unit 1	U4 malfunction
Indoor unit 2	

(4) Extended indoor unit

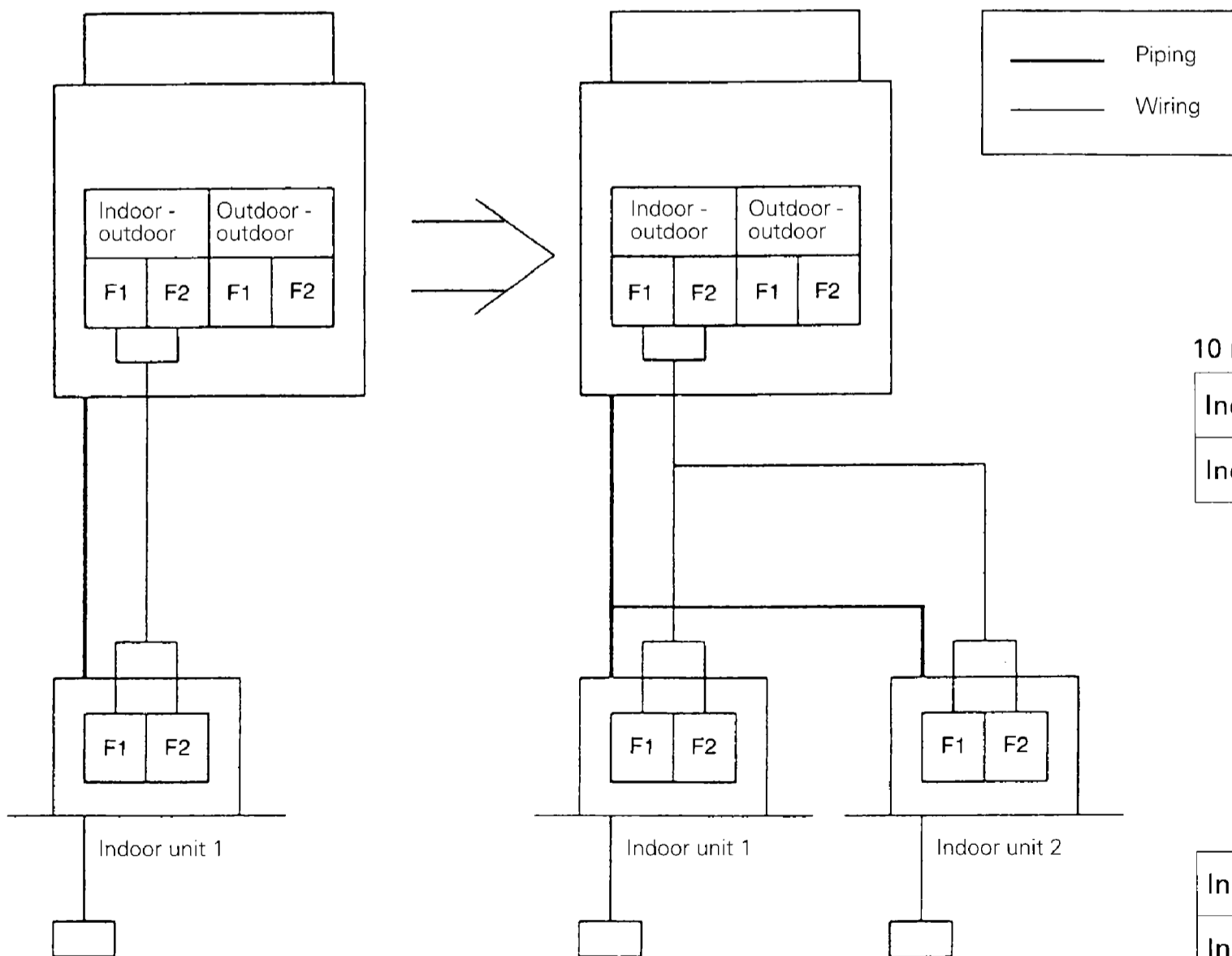

10 min. after turning power on

Indoor unit 1	Normal
Indoor unit 2	U4 malfunction

Push and hold  
RESET button for 5  
sec.

After 12 minutes  
elapse

Indoor unit 1	Normal
Indoor unit 2	Normal



(5) One of the indoor units of outdoor unit 1 is connected to outdoor-to-outdoor transmission terminals

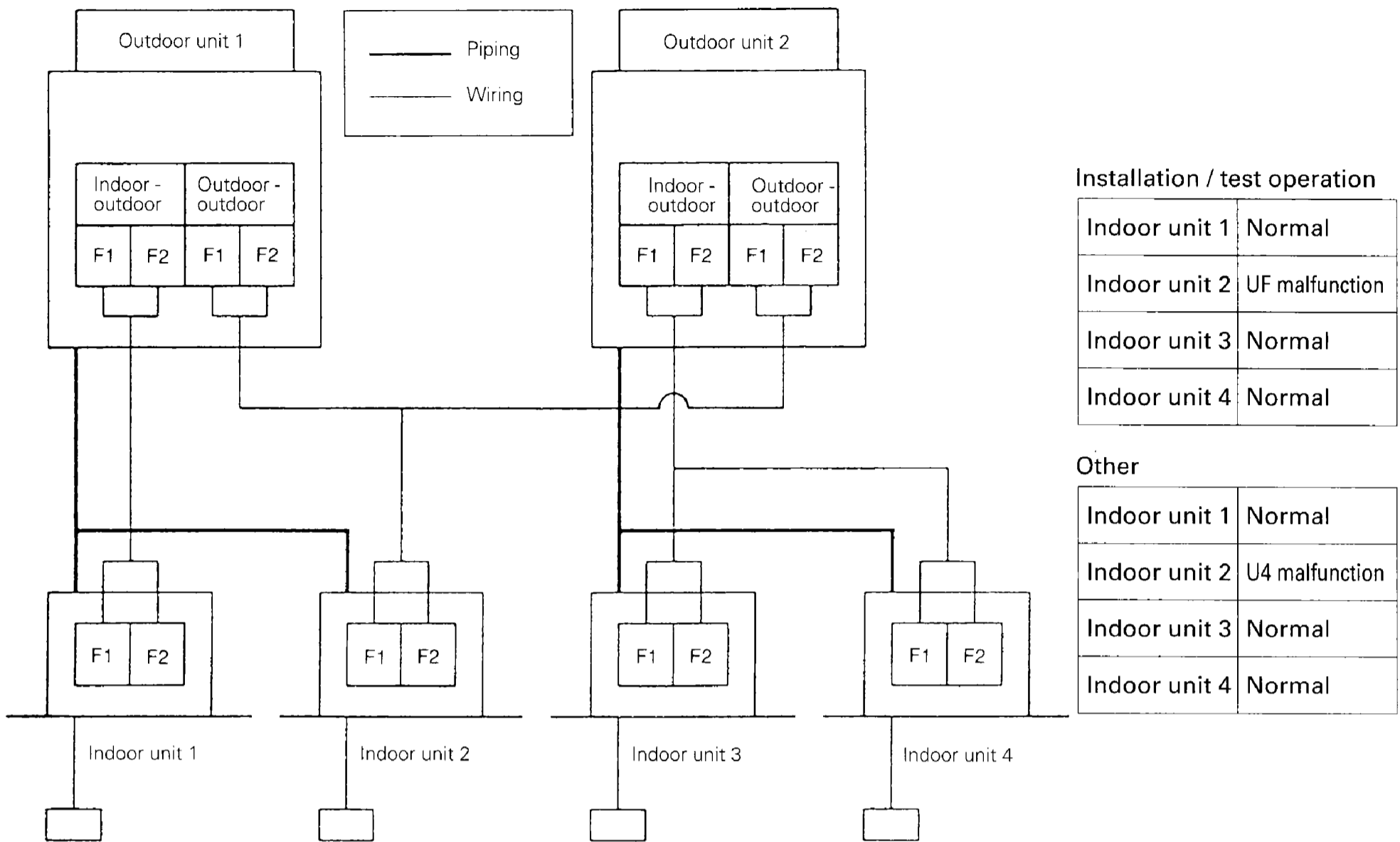

(6) The indoor-to-outdoor terminal of outdoor unit 1 and the outdoor-to-outdoor terminal of outdoor unit 2 are connected

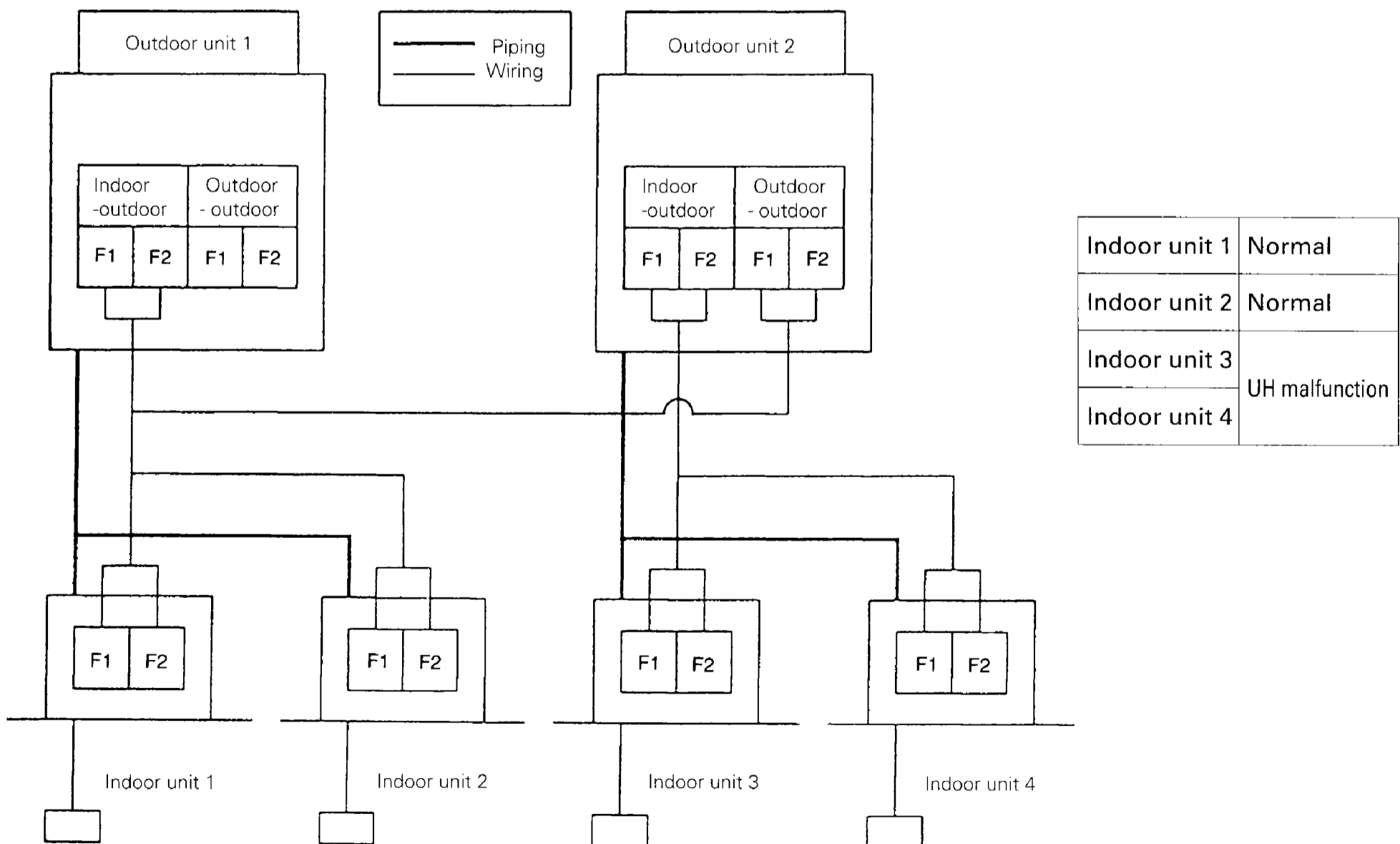

(7) The indoor-to-outdoor terminals of outdoor units 1 and 2 are connected

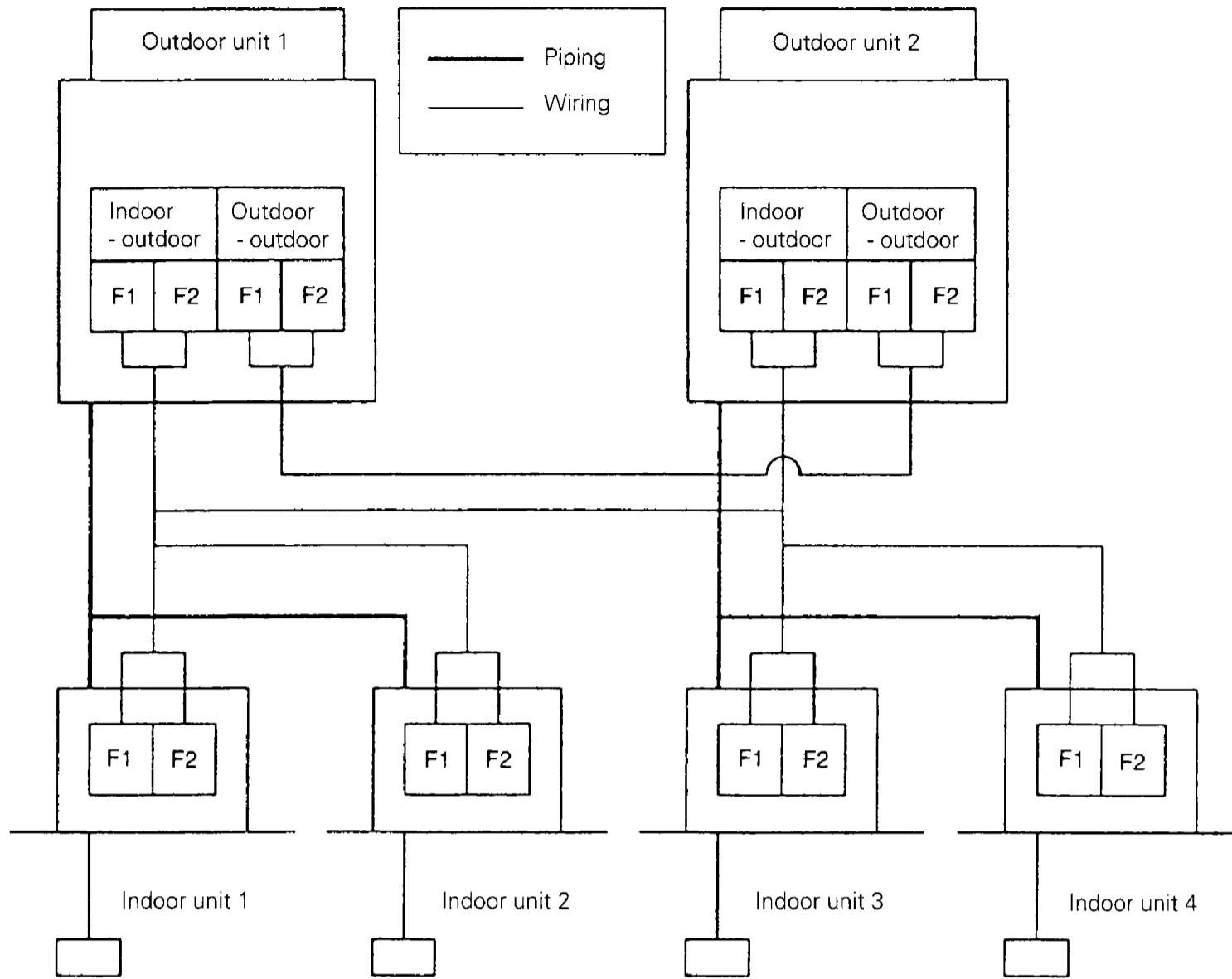

Indoor unit 1	UH malfunction
Indoor unit 2	
Indoor unit 3	
Indoor unit 4	

# **GENERAL INFORMATION**

## **PLUS Series**

# 1. Features of the VRV PLUS Series

## Improved Piping System

A newly developed function unit realizes a single piping system for the VRV PLUS Series. The series is designed for use with both heat pump system and heat recovery system type outdoor units. Reduction of piping not only aids users and designers, but facilitates installation to dramatically reduce the amount of time and labor required for connection and test operation.

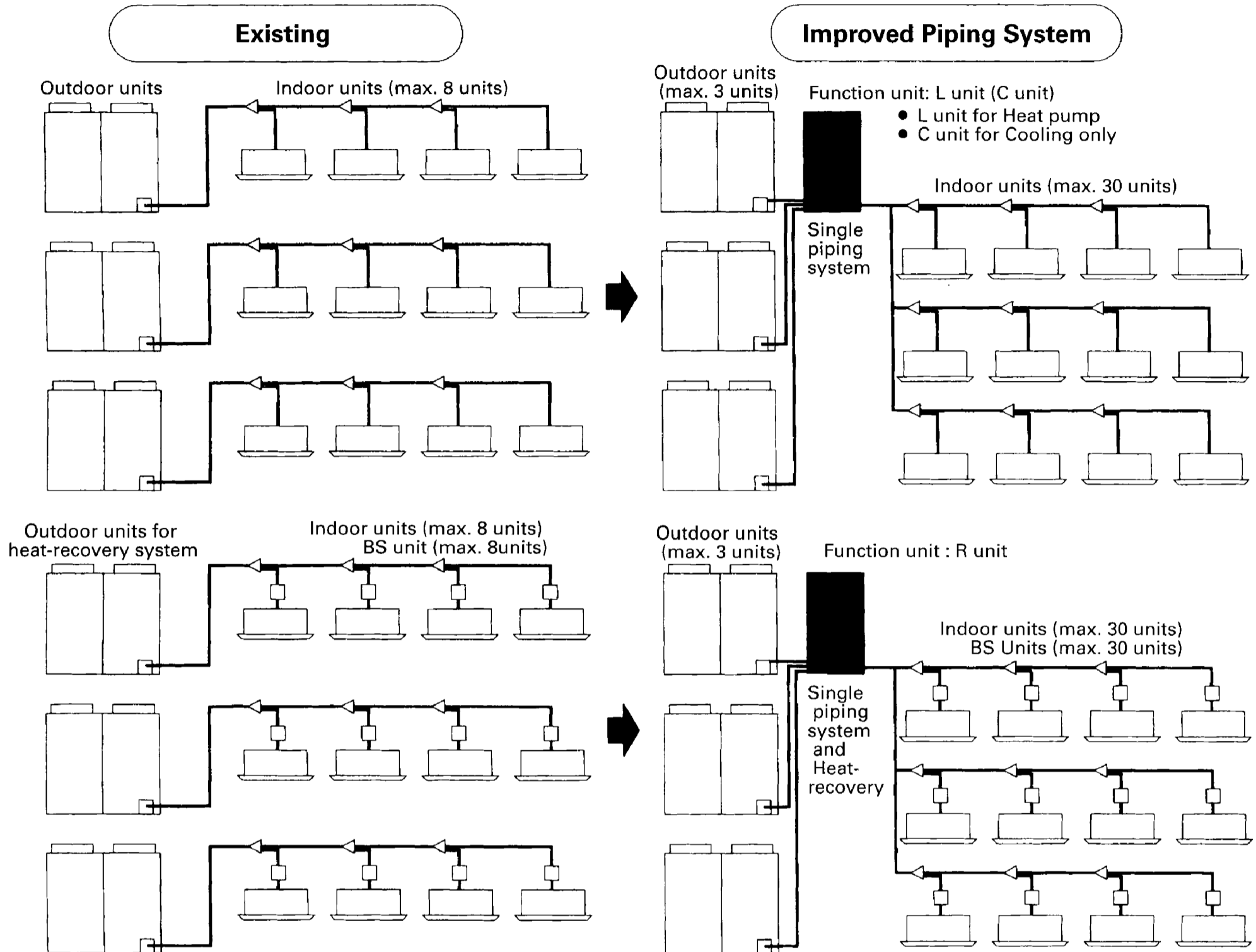

### Product Features

■ Saves Labor and Space

○ Offers 30% reduction of refrigerant piping work cost.

○ Offers approx. 70% reduction of pipe shaft and space.

3 main piping systems

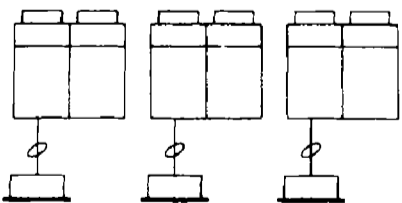

1 system

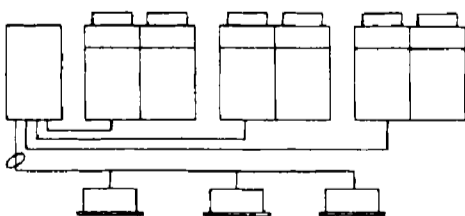

Reduction of 6 main liquid and gas pipes to 2 pipes.

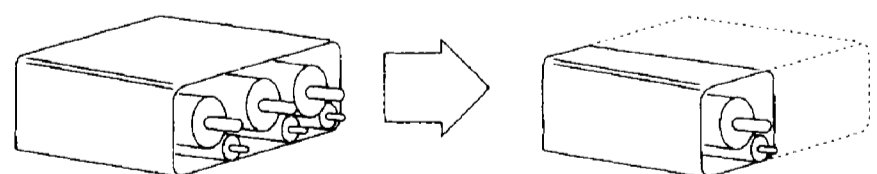

■ Combination of outdoor and function units enables selection that matches required capacity.

■ Single piping system reduces time and labor required for connection check.

## Improved Piping System

VRV PLUS Series System Example

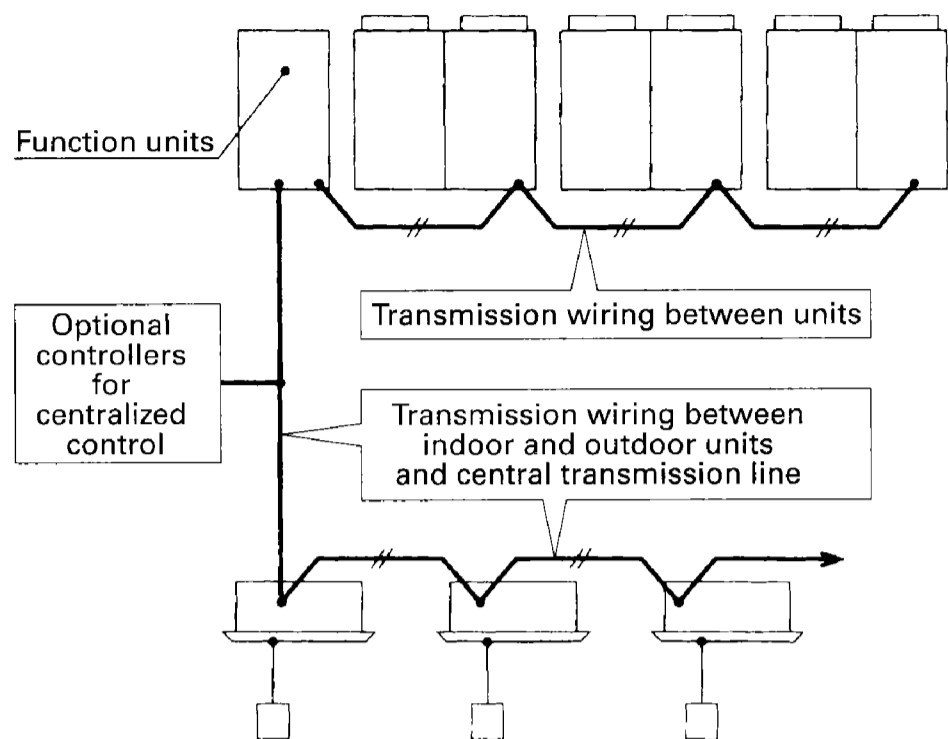

## Sales Points

■ Dramatic reduction of wiring saves time and labor when installing.

### Existing

- Transmission wiring between indoor and outdoor units (double core with polarity)
- Central transmission line (double core with polarity)



### Super Wiring

- Transmission wiring between indoor and outdoor units plus central transmission line (double core without polarity)
- D-III NET Advanced Function Junction
  - Flexible centralized control system
    - Central remote controller, unified on/off controller, schedule timer
  - Total of 128 indoor units can be controlled by centralized control.
    - Sky Air Series and HRV can be controlled simultaneously.

## Dramatic reduction of wiring saves time and labor when installing.

With the existing VRV H Series, the transmission wiring between indoor and outdoor units and central transmission line for when using a central remote controller are run separately. The VRV PLUS Series takes maximum advantage of our exclusively developed DIII-NET which boasts high speed and high performance to realize the use of an super wiring system which enables transmission signals of transmission wiring between indoor and outdoor units (on/off, cool/heat mode, preset temperature, current indoor/outdoor temperature, malfunction signals, etc.) to be used with transmission signals on the central transmission line. The dramatic reduction in wiring realized by doing so reduces wiring cost, facilitates connection, and reduces the possibility of incorrect connection in the field. Even if wires are incorrectly connected, the system is equipped with a wiring mistake check function which improves reliability of the system as a whole. Because the VRV PLUS Series uses an improved wiring system, you can connect optional controllers for centralized control anywhere on the transmission wiring between indoor and outdoor units. The system also provides flexibility for situations that may arise when designing or installing. The double-core, no-polarity wiring doesn't require special care when connecting, so you run wiring without having to worry about polarity.

### ■ Less Wiring

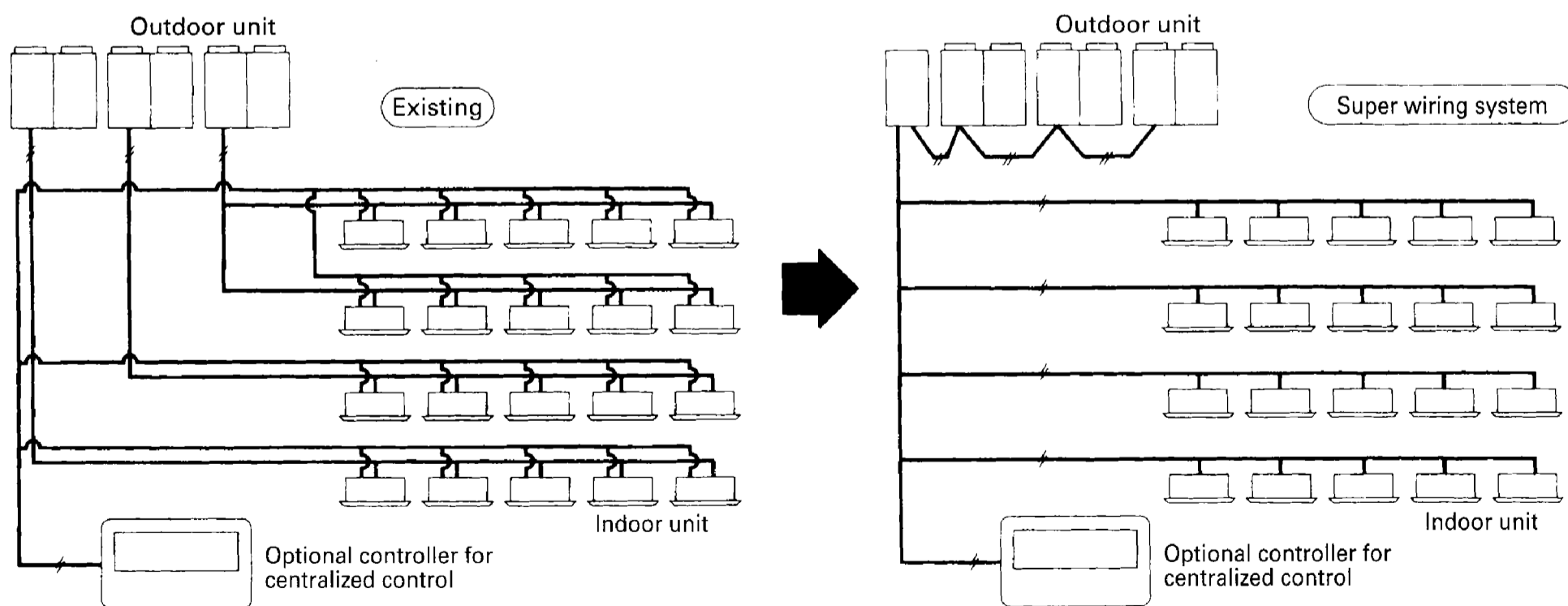

## 2. System Outline

### (1) Heat Pump and Cooling Only System

#### RX(Y)-K

##### Heat pump

L unit  
Inverter type outdoor unit  
Constant speed type outdoor unit

BL-K  
RXY-K  
RNY-K

##### Cooling only

C unit  
Inverter type outdoor unit  
Constant speed type outdoor unit

BC-K  
RX-K  
RN-K

Connectable indoor unit capacity

20type

Indoor unit connection capacity

50 - 130% of outdoor unit total capacity

No. of connectable indoor units

RX(Y)16K ~ 20K Max. 20 units

RX(Y)24K ~ 30K Max. 30 units

#### Refrigerant piping system

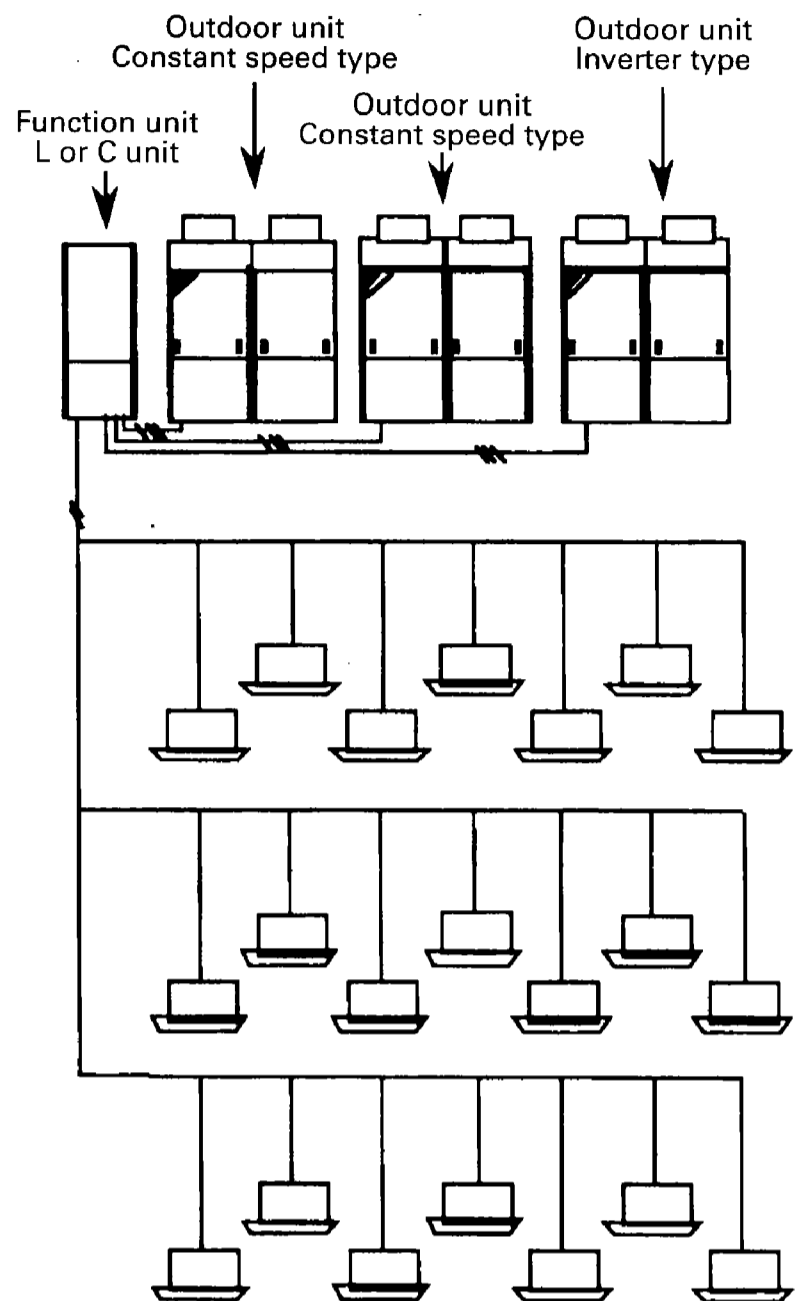

### (2) Heat Recovery System

#### REY-K

R unit  
Inverter type outdoor unit  
Constant speed type outdoor unit

BR-K  
RXY-K  
RNY-K

Connectable indoor unit capacity

20type

Indoor unit connection capacity

50 - 130% of outdoor unit total capacity

No. of connectable indoor units

REY16 ~ 20K Max. 20 units

REY24 ~ 30K Max. 30 units

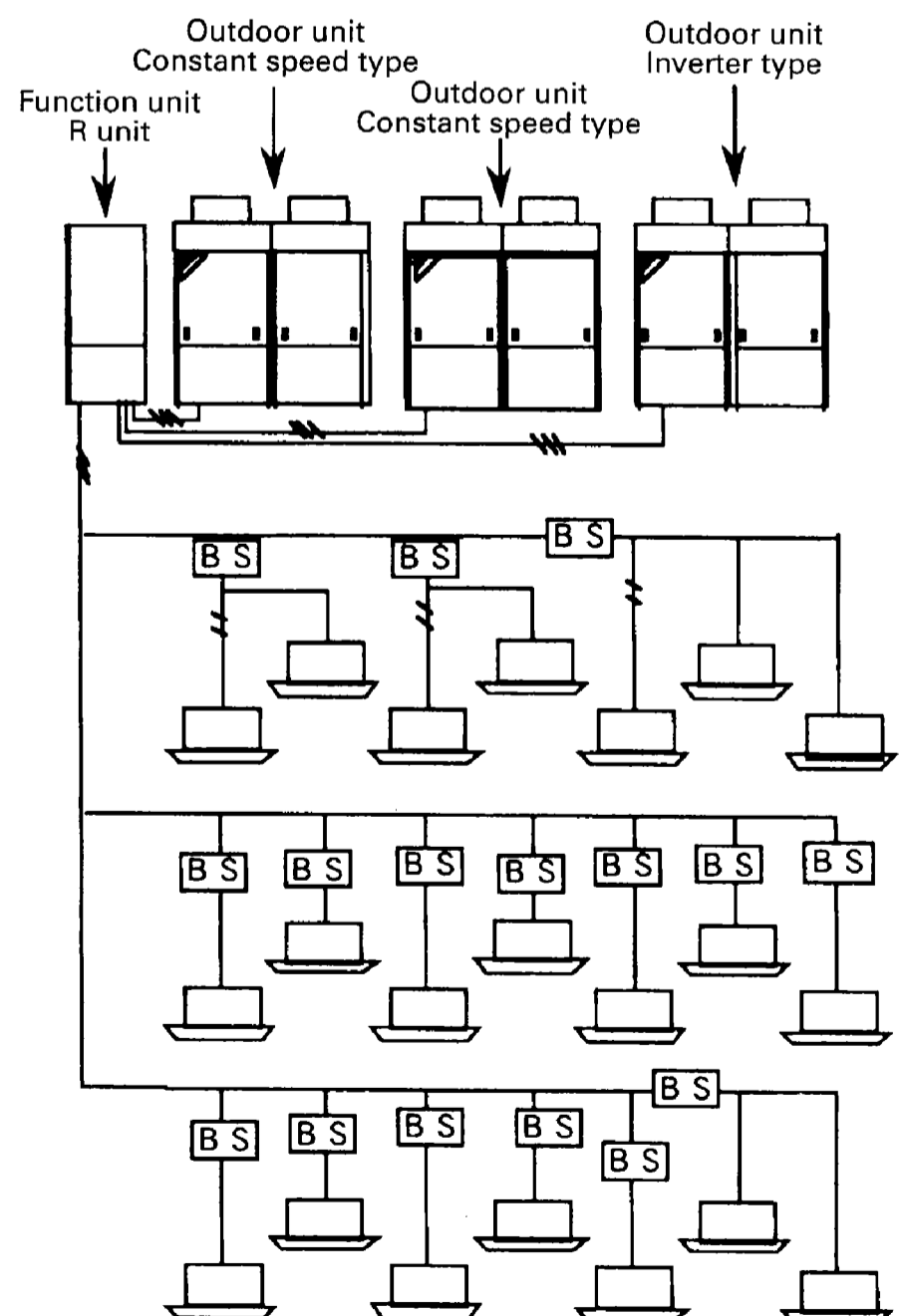

### 3. Indoor / Outdoor Unit Combinations

#### (1) Heat pump system

Model ※1	Function unit	Combination		No. of indoor unit to be connected
		Inverter	Constant speed	
RXY16K	BL 2 K	RXY 8 K	RNY 8 K	20
RXY18K		RXY10K	RNY 8 K	
RXY20K		RXY10K	RNY10K	
RXY24K	BL 3 K	RXY 8 K	RNY 8 K × 2	30
RXY26K		RXY10K	RNY 8 K × 2	
RXY28K		RXY10K	RNY 8 K × 1 RNY10K × 1	
RXY30K		RXY10K	RNY10K × 2	

※1 Combination Model name

#### (2) Cooling only system

Model ※1	Function unit	Combination		No. of indoor unit to be connected
		Inverter	Constant speed	
RX16K	BC 2 K	RX 8 K	RN 8 K	20
RX18K		RX10K	RN 8 K	
RX20K		RX10K	RN10K	
RX24K	BC 3 K	RX 8 K	RN 8 K × 2	30
RX26K		RX10K	RN 8 K × 2	
RX28K		RX10K	RN 8 K × 1 RN10K × 1	
RX30K		RX10K	RN10K × 2	

※1 Combination Model name

#### (3) Heat recovery system

Model	Function unit	Combination		No. of indoor unit to be connected
		Inverter	Constant speed	
REY16K	BR 2 K	RXY 8 K	RNY 8 K	20
REY18K		RXY10K	RNY 8 K	
REY20K		RXY10K	RNY10K	
REY24K	BR 3 K	RXY 8 K	RNY 8 K × 2	30
REY26K		RXY10K	RNY 8 K × 2	
REY28K		RXY10K	RNY 8 K × 1 RNY10K × 1	
REY30K		RXY10K	RNY10K × 2	

**MEMO**



# **FUNCTIONS**

## **PLUS Series**

# 1. Outdoor Unit Refrigerant System Diagrams

BL2K

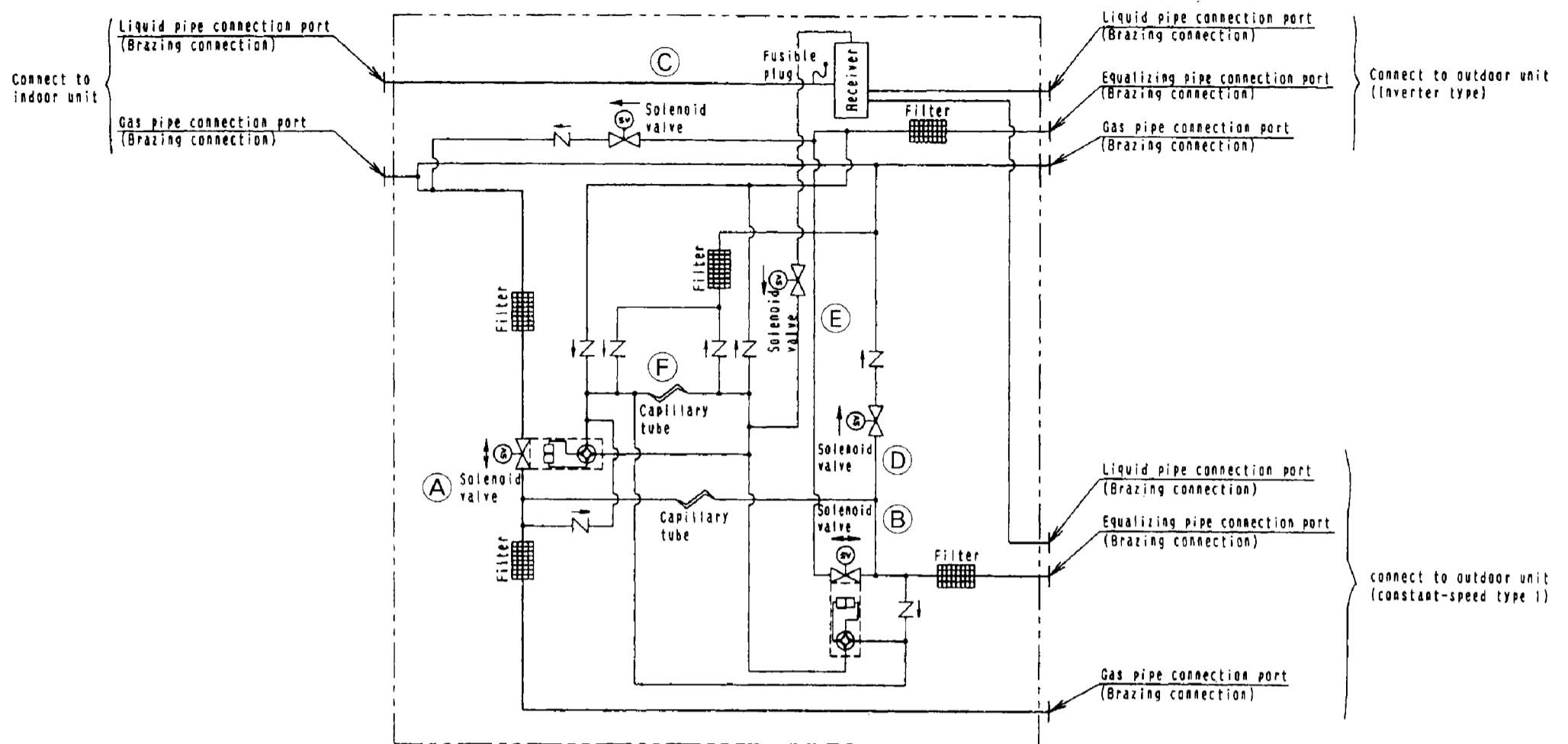

## A. Solenoid valve (for shutting system 2 gas pipe) Y1S

2-way solenoid valve for shutting the gas pipe of the second system when system 2 outdoor units are stopped during heating. (Features)

External pressure equalizing (maintains pressure difference outside the valve in order to drive the valve) 2-way solenoid valve that closes when energized and opens when not receiving power (opposite of conventional solenoid valve). Construction is similar to 4-way valve, and similarly does not operate unless there is differential pressure (3.5 kg/cm<sup>2</sup>).

## B. Solenoid valve (for shutting system 2 equalized pressure gas pipe) Y3S

2-way solenoid valve for shutting the equalized pressure gas pipe of the second system when system 2 outdoor units are stopped during cooling.

(Features)  
External pressure equalizing (maintains pressure difference outside the valve in order to drive the valve) 2-way solenoid valve that opens when energized and closes when not receiving power. Construction is similar to 4-way valve, and similarly does not operate unless there is differential pressure (3.5 kg/cm<sup>2</sup>).

## C. Solenoid valve (for system 1 devices) Y5S

Solenoid valve primarily for supplying system 2 and 3 outdoor units with excess oil from system 1 outdoor units during cooling oil equalizing operation. (Pressure equalized pipes are closed at this time.)

## D. Solenoid valve (for system 2 bypass) Y6S

Solenoid valve primarily for supplying system 1 outdoor units with excess oil from system 2 outdoor units during cooling oil equalizing operation. (Pressure equalized pipes are closed at this time.)

## E. Solenoid valve (for hot gas equalizing) Y8S

Solenoid primarily for equalizing pressure of refrigerant in liquid pipes when the compressor is stopped, but is also used for high and low pressure protection.

## F. Check valve bridge circuit

Constant high pressure or constant low pressure are created by the check valve in order to provide solenoid valve A with differential pressure.

# BL3K

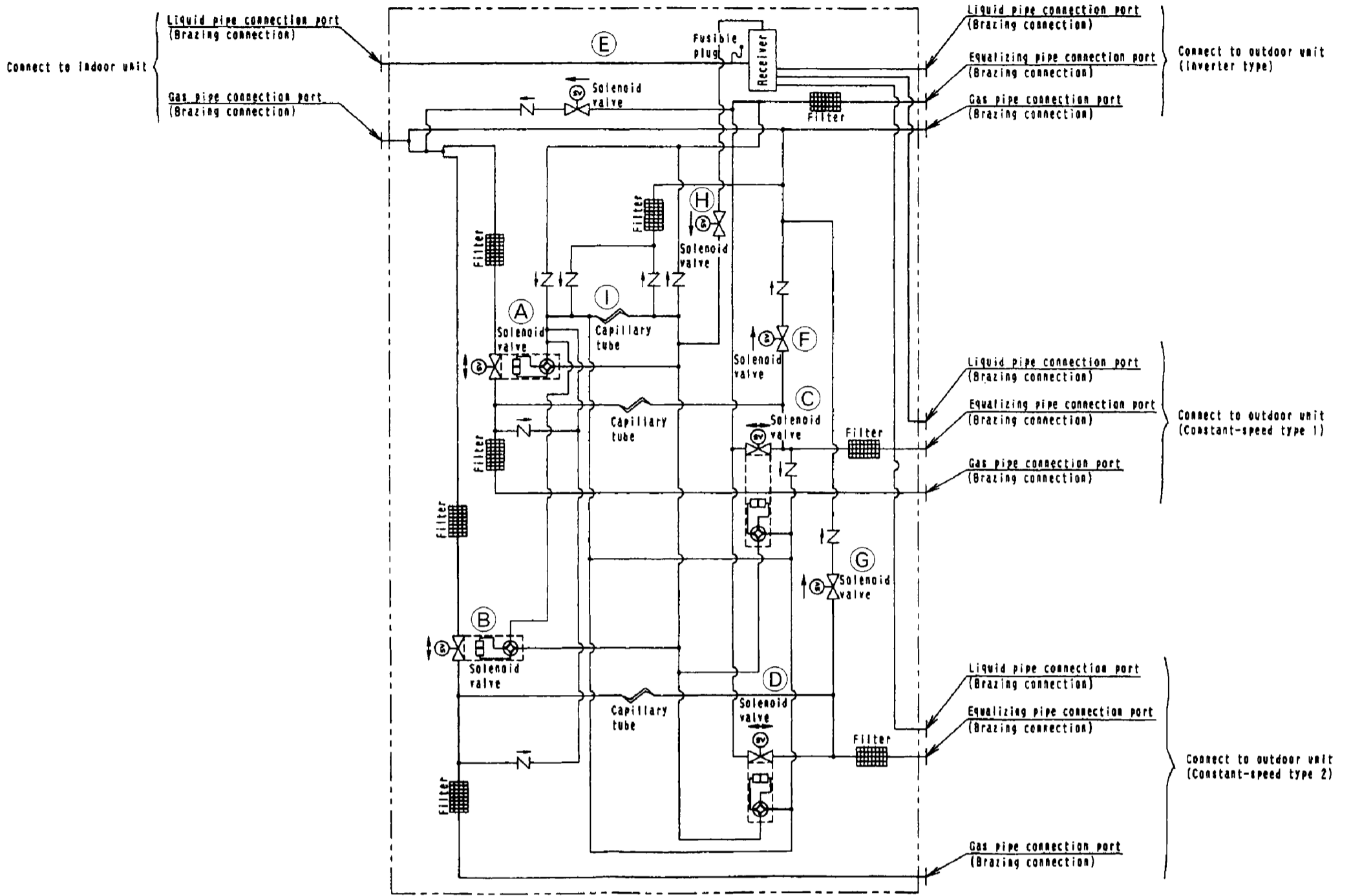

#### **A. Solenoid valve (for shutting system 2 gas pipe) Y1S**

2-way solenoid valve for shutting the gas pipe of the second system when system 2 outdoor units are stopped during heating.

(Features)

External pressure equalizing (maintains pressure difference outside the valve in order to drive the valve) 2-way solenoid valve that closes when energized and opens when not receiving power (opposite of conventional solenoid valve). Construction is similar to 4-way valve, and similarly does not operate unless there is differential pressure (3.5 kg/cm<sup>2</sup>)

#### **B. Solenoid valve (for shutting system 3 gas pipe) Y2S**

2-way solenoid valve for shutting the gas pipe of the third system when system 3 outdoor units are stopped during heating. The valve itself is the same as solenoid valve A.

#### **C. Solenoid valve (for shutting system 2 equalized pressure gas pipe) Y3S**

2-way solenoid valve for shutting the equalized pressure gas pipe of the second system when system 2 outdoor units are stopped during cooling.

(Features)

External pressure equalizing (maintains pressure difference outside the valve in order to drive the valve) 2-way solenoid valve that opens when energized and closes when not receiving power. Construction is similar to 4-way valve, and similarly does not operate unless there is differential pressure (3.5 kg/cm<sup>2</sup>).

#### **D. Solenoid valve (for shutting system 3 equalized pressure gas pipe) Y4S**

2-way solenoid valve for shutting the equalized pressure gas pipe of the third system when system 3 outdoor units are stopped during cooling. The valve itself is the same as solenoid valve C.

#### **E. Solenoid valve (for system 1 bypass) Y5S**

Solenoid valve primarily for supplying system 2 and 3 outdoor units with excess oil from system 1 outdoor units during cooling oil equalizing operation. (Pressure equalized pipes are closed at this time.)

#### **F. Solenoid valve (for system 2 bypass) Y6S**

Solenoid valve primarily for supplying system 1 outdoor units with excess oil from system 2 outdoor units during cooling oil equalizing operation.

#### **G. Solenoid valve (for system 3 bypass) Y7S**

Solenoid valve primarily for supplying system 1 outdoor units with excess oil from system 3 outdoor units during cooling oil equalizing operation.

#### **H. Solenoid valve (for hot gas equalizing) Y8S**

Solenoid primarily for equalizing pressure of refrigerant in liquid pipes when the compressor is stopped, but is also used for high and low pressure protection.

#### **I. Check valve bridge circuit**

Constant high pressure or constant low pressure are created by the check valve in order to provide solenoid valve A with differential pressure.

# BR2K

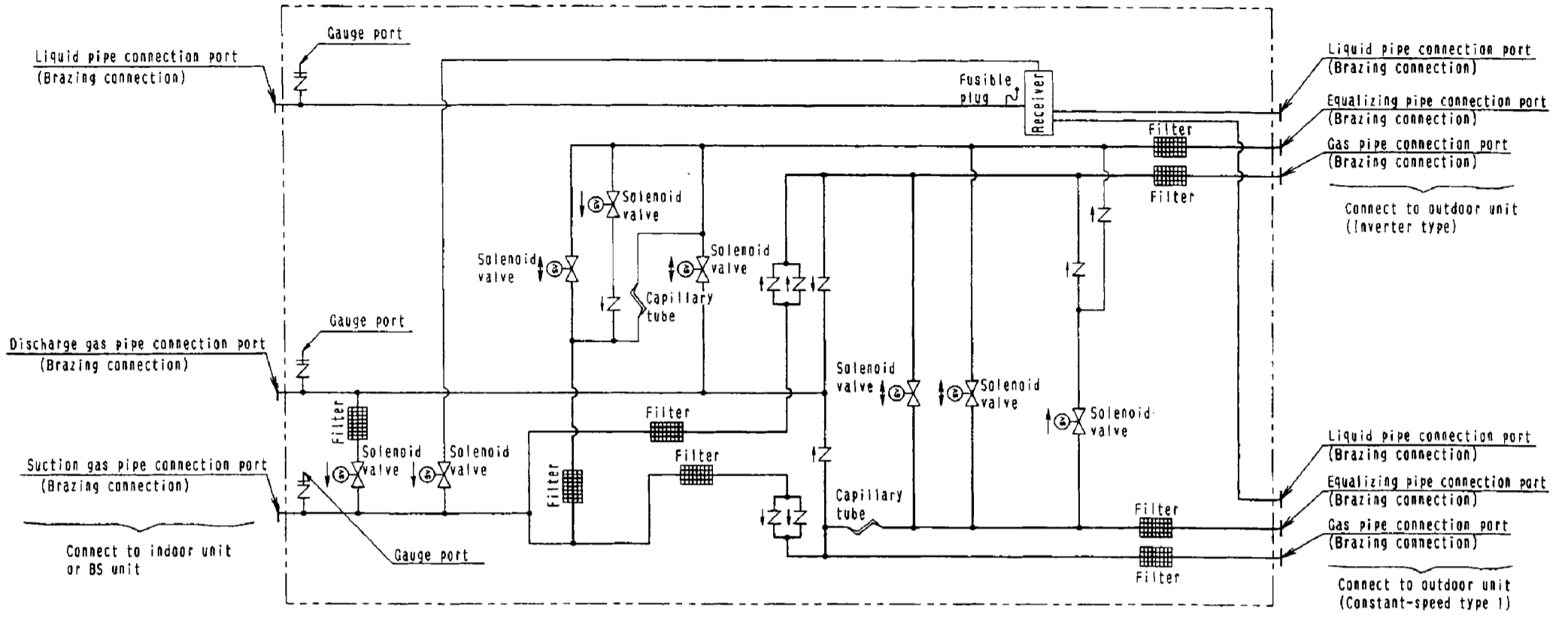

# BR3K

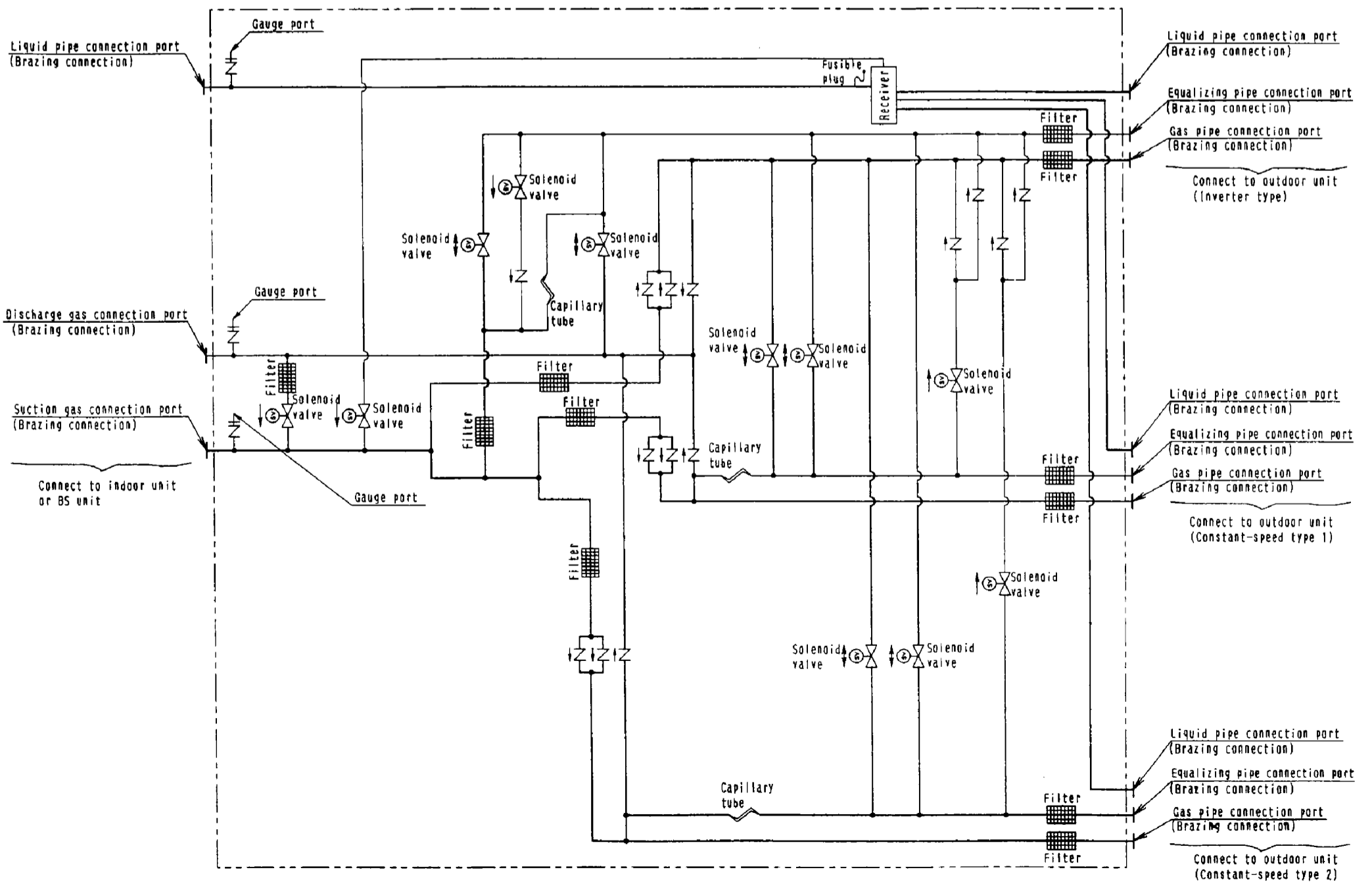

## BC2K

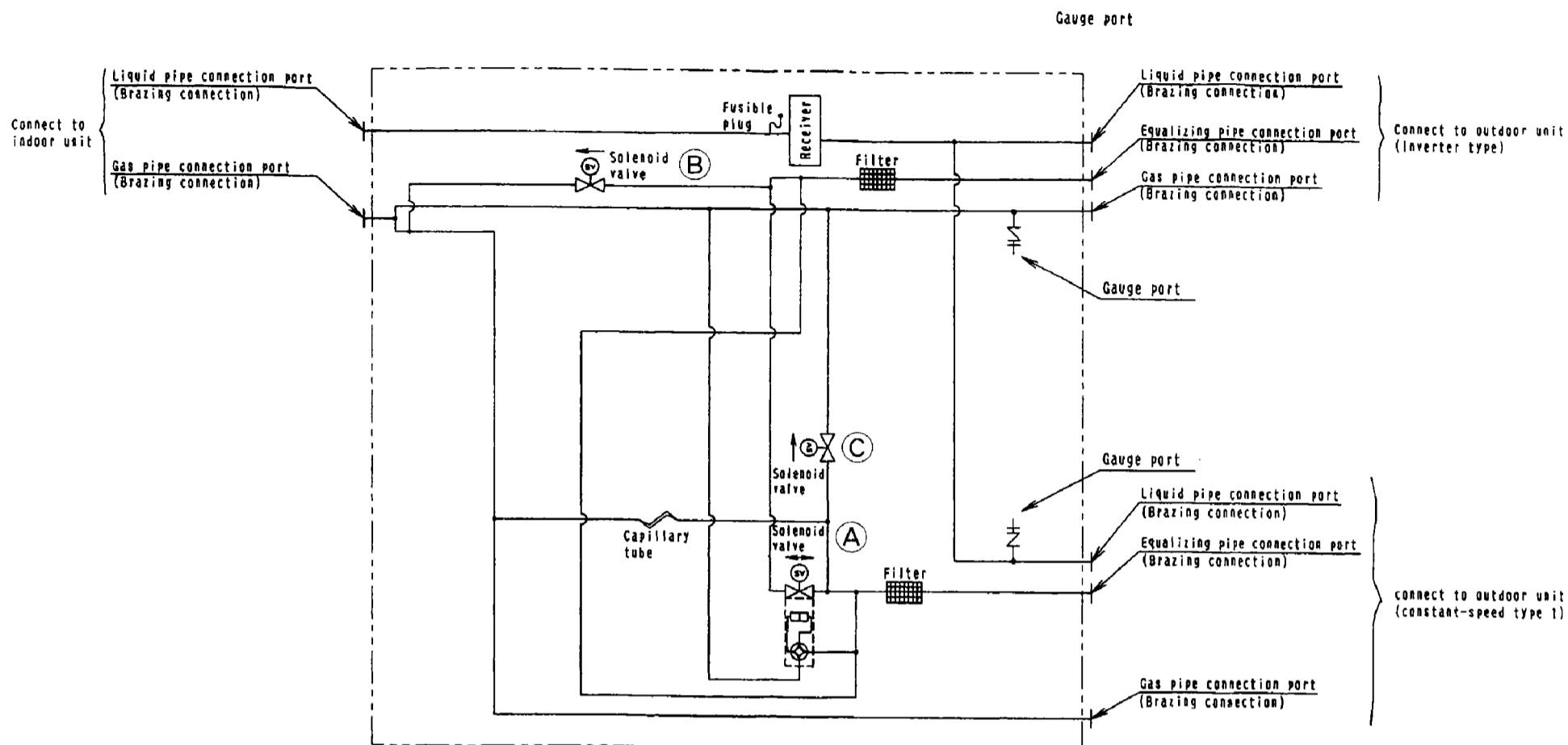

### A. Solenoid valve (for shutting system 2 equalized pressure gas pipe) Y3S

2-way solenoid valve for shutting the equalized pressure gas pipe of the second system when system 2 outdoor units are stopped during cooling.

(Features)

External pressure equalizing (maintains pressure difference outside the valve in order to drive the valve) 2-way solenoid valve that opens when energized and closes when not receiving power. Construction is similar to 4-way valve, and similarly does not operate unless there is differential pressure (3.5 kg/cm<sup>2</sup>).

### B. Solenoid valve (for system 1 devices) Y5S

Solenoid valve primarily for supplying system 2 and 3 outdoor units with excess oil from system 1 outdoor units during cooling oil equalizing operation. (Pressure equalized pipes are closed at this time.)

### C. Solenoid valve (for system 2 bypass) Y6S

Solenoid valve primarily for supplying system 1 outdoor units with excess oil from system 2 outdoor units during cooling oil equalizing operation. (Pressure equalized pipes are closed at this time.)

## BC3K

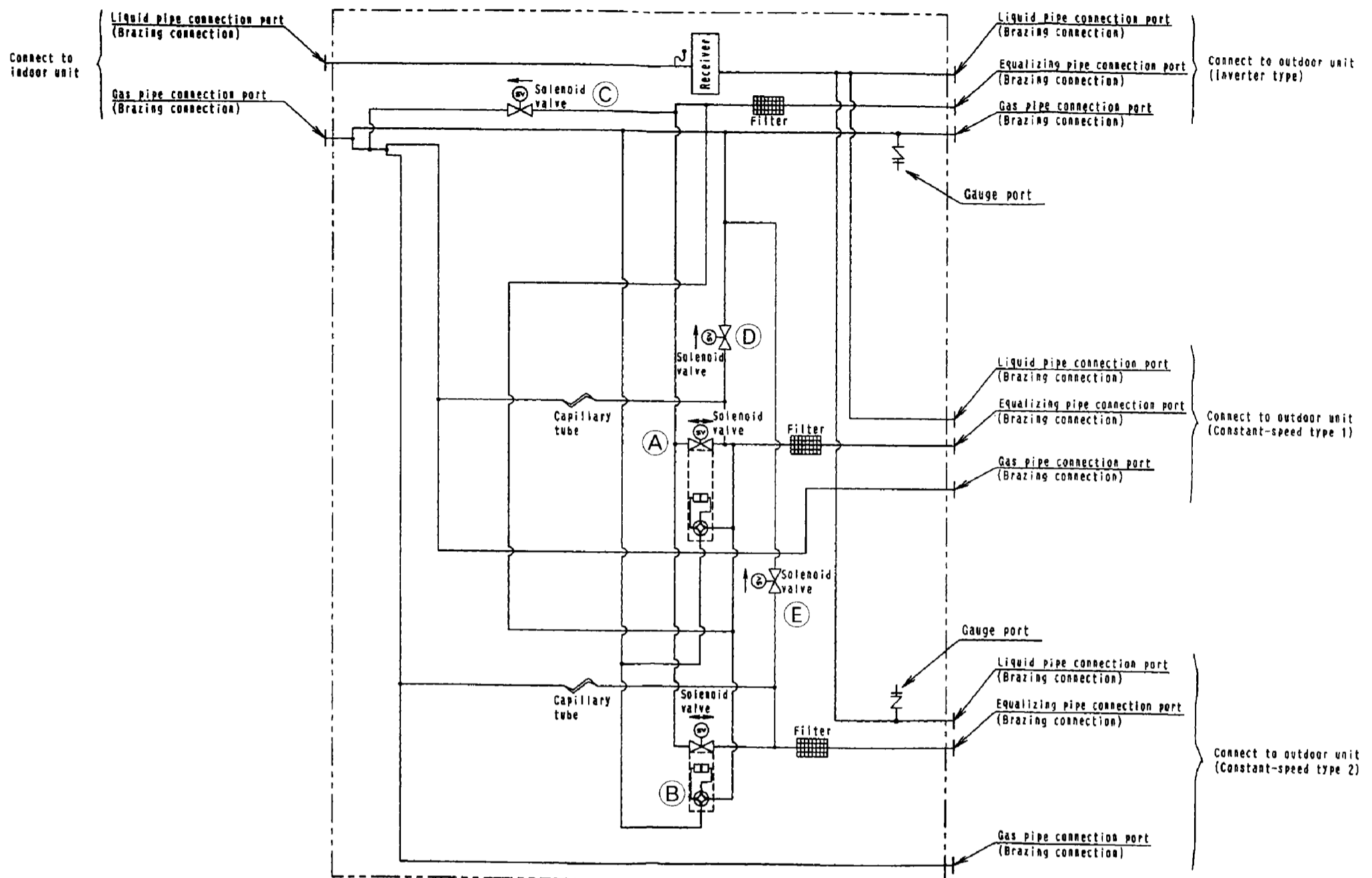

### A. Solenoid valve (for shutting system 2 equalized pressure gas pipe) Y3S

2-way solenoid valve for shutting the equalized pressure gas pipe of the second system when system 2 outdoor units are stopped during cooling.

(Features)

External pressure equalizing (maintains pressure difference outside the valve in order to drive the valve) 2-way solenoid valve that opens when energized and closes when not receiving power. Construction is similar to 4-way valve, and similarly does not operate unless there is differential pressure (3.5 kg/cm<sup>2</sup>).

### B. Solenoid valve (for shutting system 3 equalized pressure gas pipe) Y4S

2-way solenoid valve for shutting the equalized pressure gas pipe of the third system when system 3 outdoor units are stopped during cooling. The valve itself is the same as solenoid valve C.

### C. Solenoid valve (for system 1 bypass) Y5S

Solenoid valve primarily for supplying system 2 and 3 outdoor units with excess oil from system 1 outdoor units during cooling oil equalizing operation. (Pressure equalized pipes are closed at this time.)

### D. Solenoid valve (for system 2 bypass) Y6S

Solenoid valve primarily for supplying system 1 outdoor units with excess oil from system 2 outdoor units during cooling oil equalizing operation.

### E. Solenoid valve (for system 3 bypass) Y7S

Solenoid valve primarily for supplying system 1 outdoor units with excess oil from system 3 outdoor units during cooling oil equalizing operation.

RXY8K · 10K (8. 10HP)

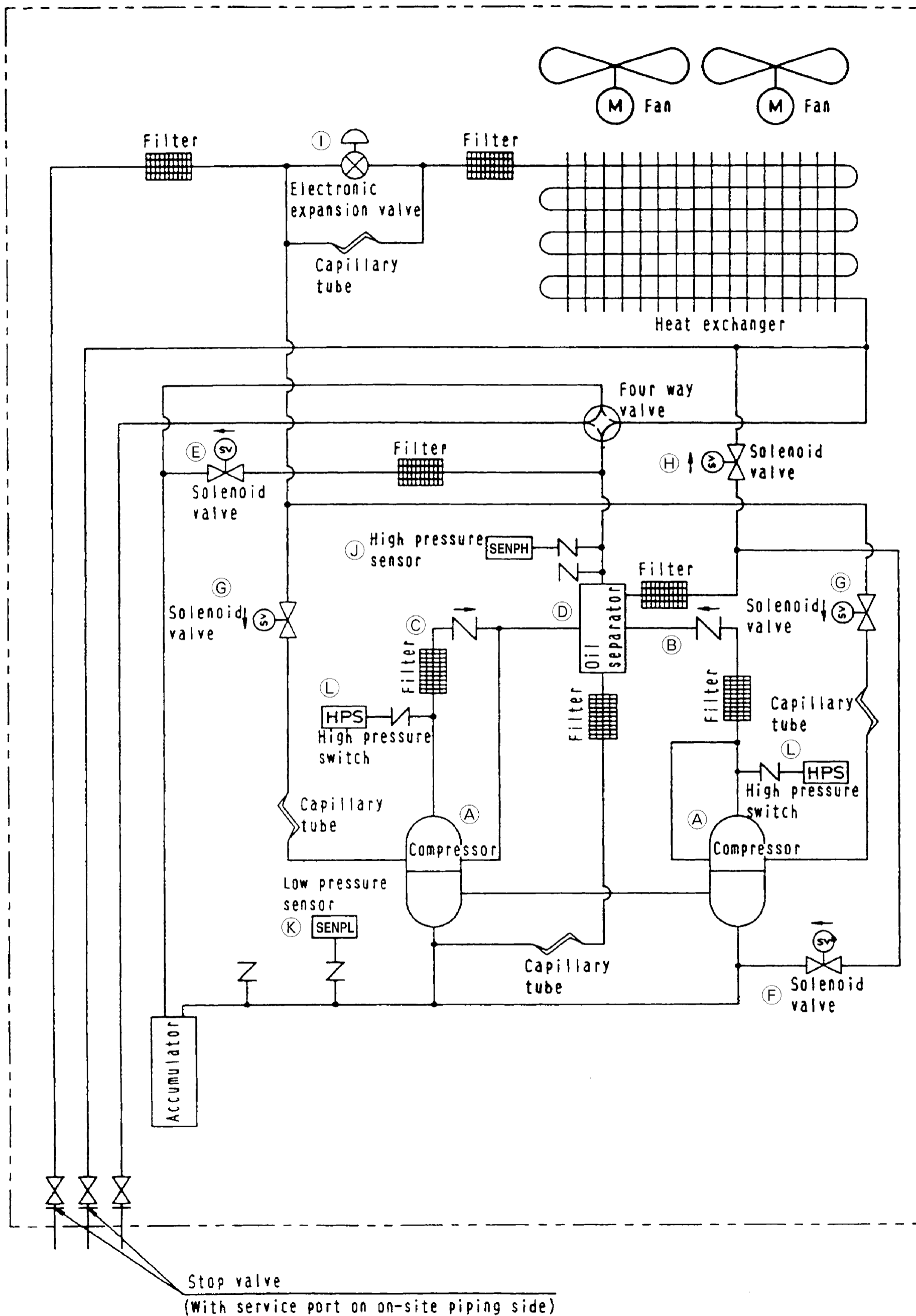



#### **A. Compressor**

A combination of scroll compressor enabling operation at 30 - 106 Hz by inverter and constant speed type compressor for carrying out on/off control realizes capacity control in 19 steps, and carries out capacity control for individual and linear control of indoor units. Compressors are equipped with an oil discharge function for draining excess oil from the high pressure side.

#### **B. Check valve**

Prevents refrigerant from collecting in the constant speed type when operating the inverter type units only.

#### **C. Check valve**

Installed so that the inverter type's oil discharge function functions properly.

#### **D. Oil separator**

Device which collected oil discharged from the compressor and returns it to the compressor via capillary tubes. Also functions as reservoir for holding excess oil.

#### **E. Solenoid valve (for low pressure protection) Y1S**

Provides hot gas bypass to prevent low pressure from dropping radically for excessive defrost or load reduction when the compressor starts.

#### **F. Solenoid valve (for pressure equalization) Y4S**

Balances high and low pressure when stopped.

#### **G. Solenoid valve (for liquid injection) Y2S, Y3S**

Controls liquid injection to prevent overheating.

#### **H. Solenoid valve (for oil control) Y5S**

Discharges excess oil to other outdoor units during oil equalization operation.

#### **I. Outdoor unit electronic expansion valve Y1E**

Expansion valve for heating. Senses low pressure and temperature of outdoor unit heat exchanger outlets and carries out overheating control.

#### **J. High pressure sensor SENPH**

Semiconductor pressure sensor for detecting outdoor unit high pressure.

#### **K. Low pressure sensor SENPL**

Semiconductor pressure sensor for detecting outdoor unit low pressure.

#### **L. High pressure switches S1HP, S2HP**

Switches trip when discharge pressure exceeds  $27.5 \pm 0.5K$ , thus stopping operation.

RNY8K · 10K (8.10HP)

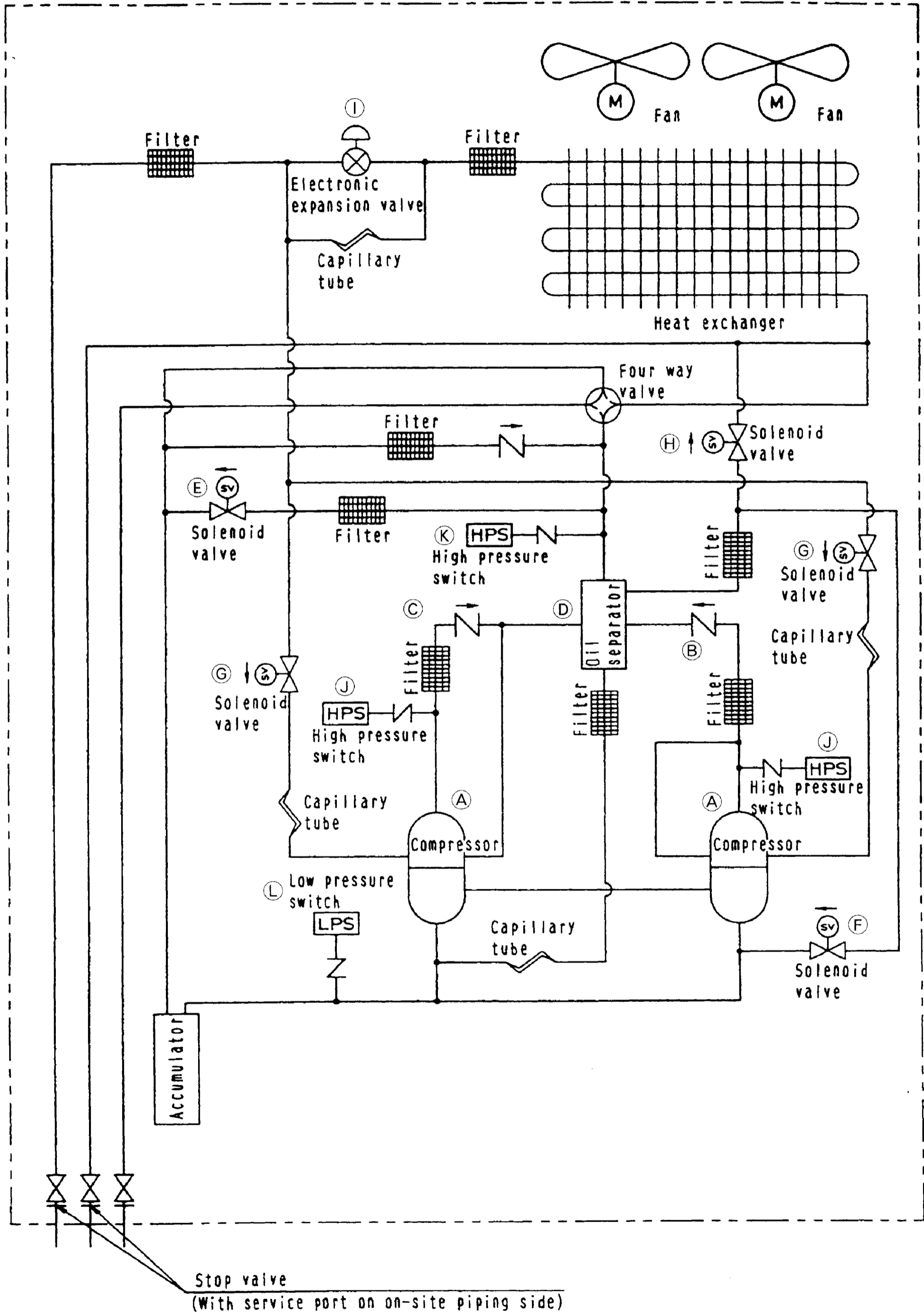

**A. Compressor**

Controls capacity of 0 - 45 - 100% by combination of constant speed type compressors 1 and 2. Compressor is equipped with an oil discharge function for draining excess oil from the high pressure side.

**B. Check valve**

Prevents refrigerant from collecting in the constant speed type compressor 2 when operating constant speed type compressor 1 only.

**C. Check valve**

Installed so that constant speed type compressor 1's oil discharge function functions properly.

**D. Oil separator**

Device which collected oil discharged from the compressor and returns it to the compressor via capillary tubes. Also functions as reservoir for holding excess oil.

**E. Solenoid valve (for low pressure protection) Y1S**

Provides hot gas bypass to prevent low pressure from dropping radically for excessive defrost of load reduction when the compressor starts.

**F. Solenoid valve (for pressure equalization) Y4S**

Balances high and low pressure when stopped.

**G. Solenoid valve (for liquid injection) Y2S, Y3S**

Controls liquid injection to prevent overheating.

**H. Solenoid valve (for oil discharge) Y5S**

Discharges excess oil to other outdoor units during oil equalization operation.

**I. Outdoor unit electronic expansion valve Y1E**

Expansion valve for heating. Senses low pressure and temperature of outdoor unit heat exchanger outlets and carries out overheating control.

**J. High pressure switches S1HP, S2HP**

Switches trip when preset pressure exceeds  $27.5 \pm 0.5K$ , thus stopping operation.

**K. High pressure switch S3HP**

Switch trips when operation pressure exceeds  $24.0K$  and switch on at  $17.0K$ , thus control high pressure.

**L. Low pressure switch S1PL**

Switches trip when the suction pressure is lower than  $0 \pm 0.3K$ .

RX8K · 10K (8.10HP)

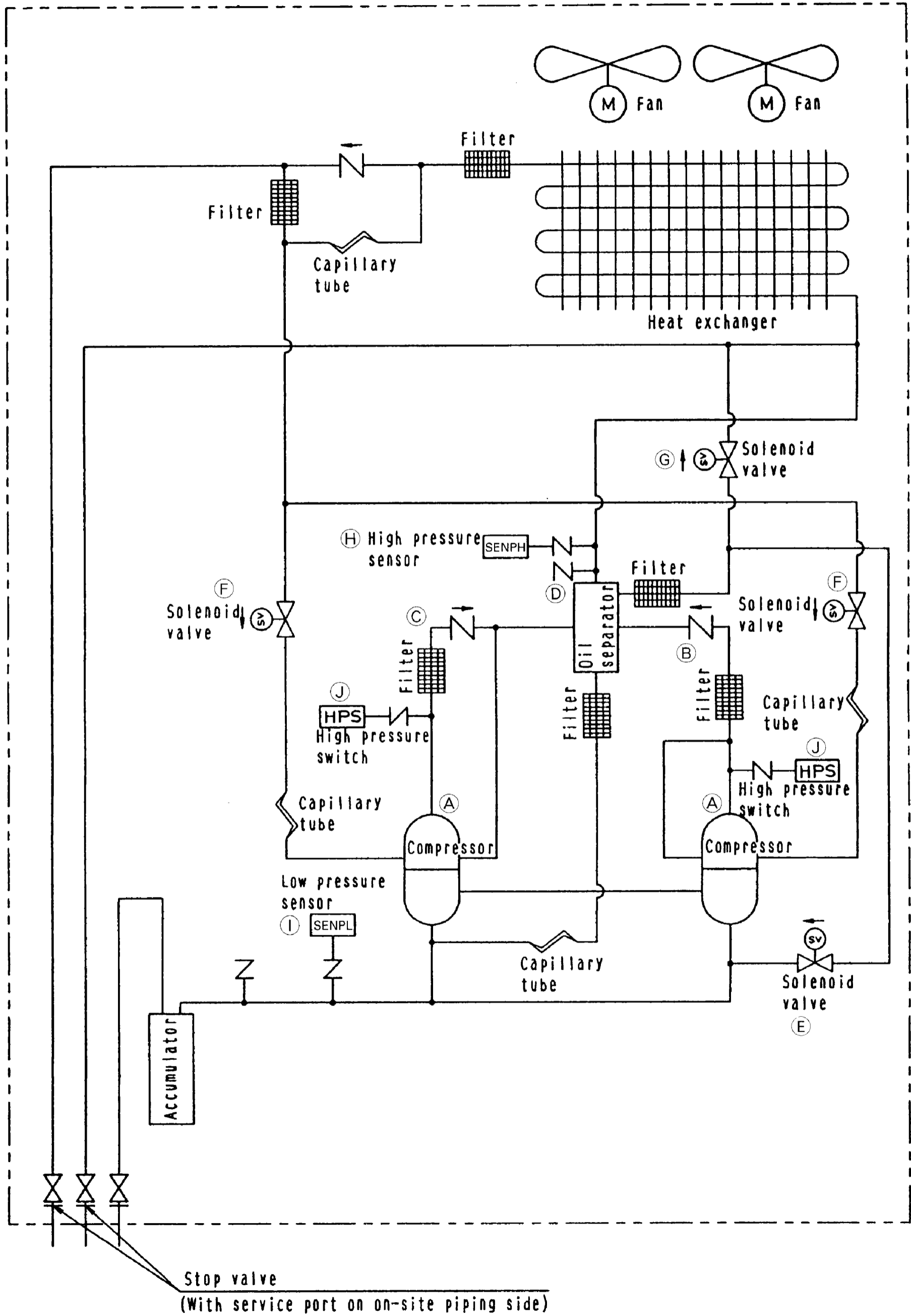

**A. Compressor**

A combination of scroll compressor enabling operation at 30 - 106 Hz by inverter and constant speed type compressor for carrying out on/off control realizes capacity control in 19 steps, and carries out capacity control for individual and linear control of indoor units. Compressors are equipped with an oil discharge function for draining excess oil from the high pressure side.

**B. Check valve**

Prevents refrigerant from collecting in the constant speed type when operating the inverter type units only.

**C. Check valve**

Installed so that the inverter type's oil discharge function functions properly.

**D. Oil separator**

Device which collected oil discharged from the compressor and returns it to the compressor via capillary tubes. Also functions as reservoir for holding excess oil.

**E. Solenoid valve (for pressure equalization) Y4S**

Balances high and low pressure when stopped.

**F. Solenoid valve (for liquid injection) Y2S, Y3S**

Controls liquid injection to prevent overheating.

**G. Solenoid valve (for oil control) Y5S**

Discharges excess oil to other outdoor units during oil equalization operation.

**H. High pressure sensor SENPH**

Semiconductor pressure sensor for detecting outdoor unit high pressure.

**I. Low pressure sensor SENPL**

Semiconductor pressure sensor for detecting outdoor unit low pressure.

**J. High pressure switches S1HP, S2HP**

Switches trip when discharge pressure exceeds  $27.5 \pm 0.5K$ , thus stopping operation.

RN8K · 10K (8.10HP)

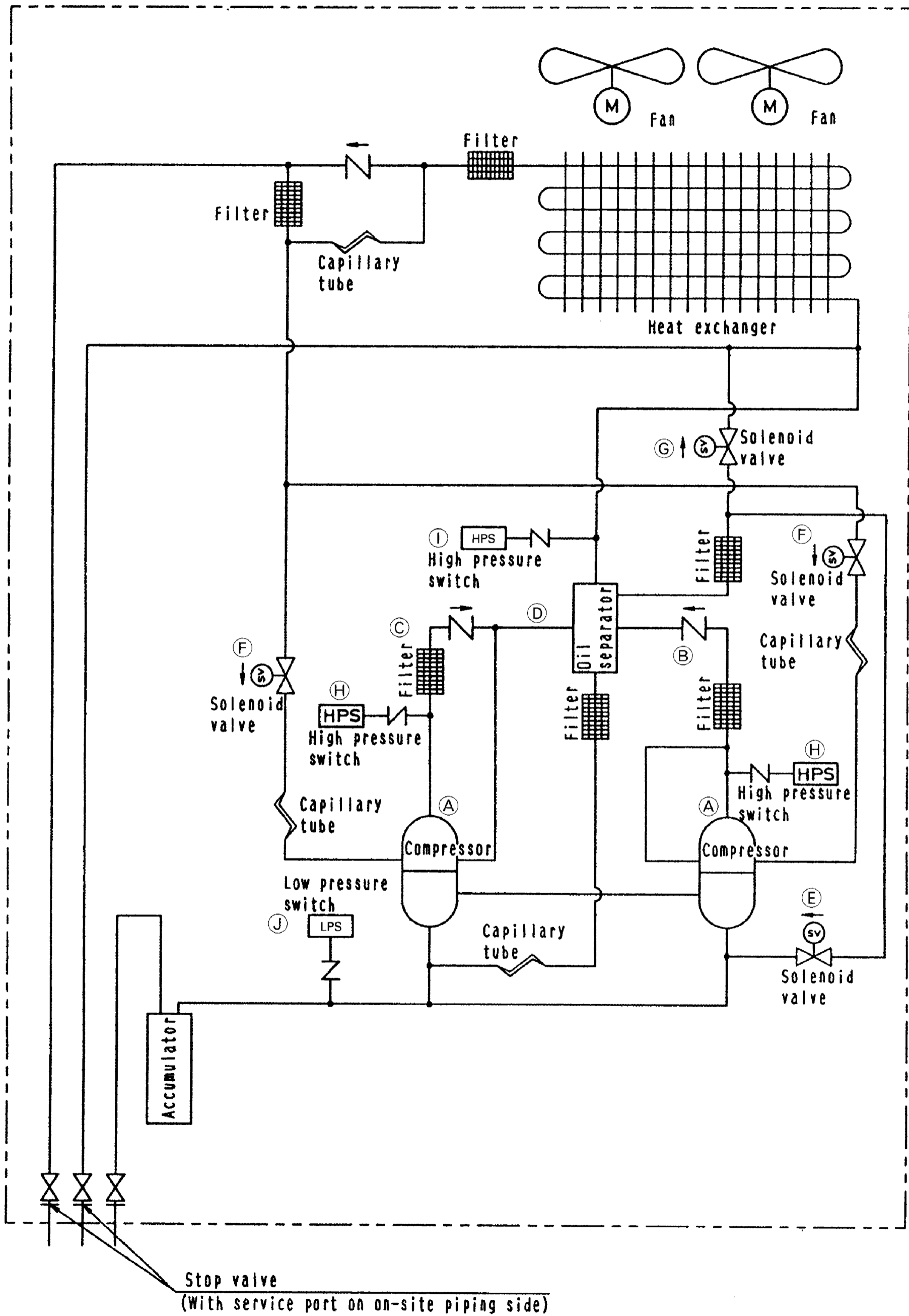

**A. Compressor**

Controls capacity of 0 - 45 - 100% by combination of constant speed type compressors 1 and 2. Compressor is equipped with an oil discharge function for draining excess oil from the high pressure side.

**B. Check valve**

Prevents refrigerant from collecting in the constant speed type compressor 2 when operating constant speed type compressor 1 only.

**C. Check valve**

Installed so that constant speed type compressor 1's oil discharge function functions properly.

**D. Oil separator**

Device which collected oil discharged from the compressor and returns it to the compressor via capillary tubes. Also functions as reservoir for holding excess oil.

**E. Solenoid valve (for pressure equalization) Y4S**

Balances high and low pressure when stopped.

**F. Solenoid valve (for liquid injection) Y2S, Y3S**

Controls liquid injection to prevent overheating.

**G. Solenoid valve (for oil discharge) Y5S**

Discharges excess oil to other outdoor units during oil equalization operation.

**H. High pressure switches S1HP, S2HP**

Switches trip when preset pressure exceeds  $27.5 \pm 0.5K$ , thus stopping operation.

**I. High pressure switch S3HP**

Switch trips when operation pressure exceeds  $24.0K$  and switch on at  $17.0K$ , thus control high pressure.

**J. Low pressure switch S1PL**

Switches trip when the suction pressure is lower than  $0 \pm 0.3K$ .

## 2. Function of Thermistors and Pressure Sensors

RX(Y)8K, 10K

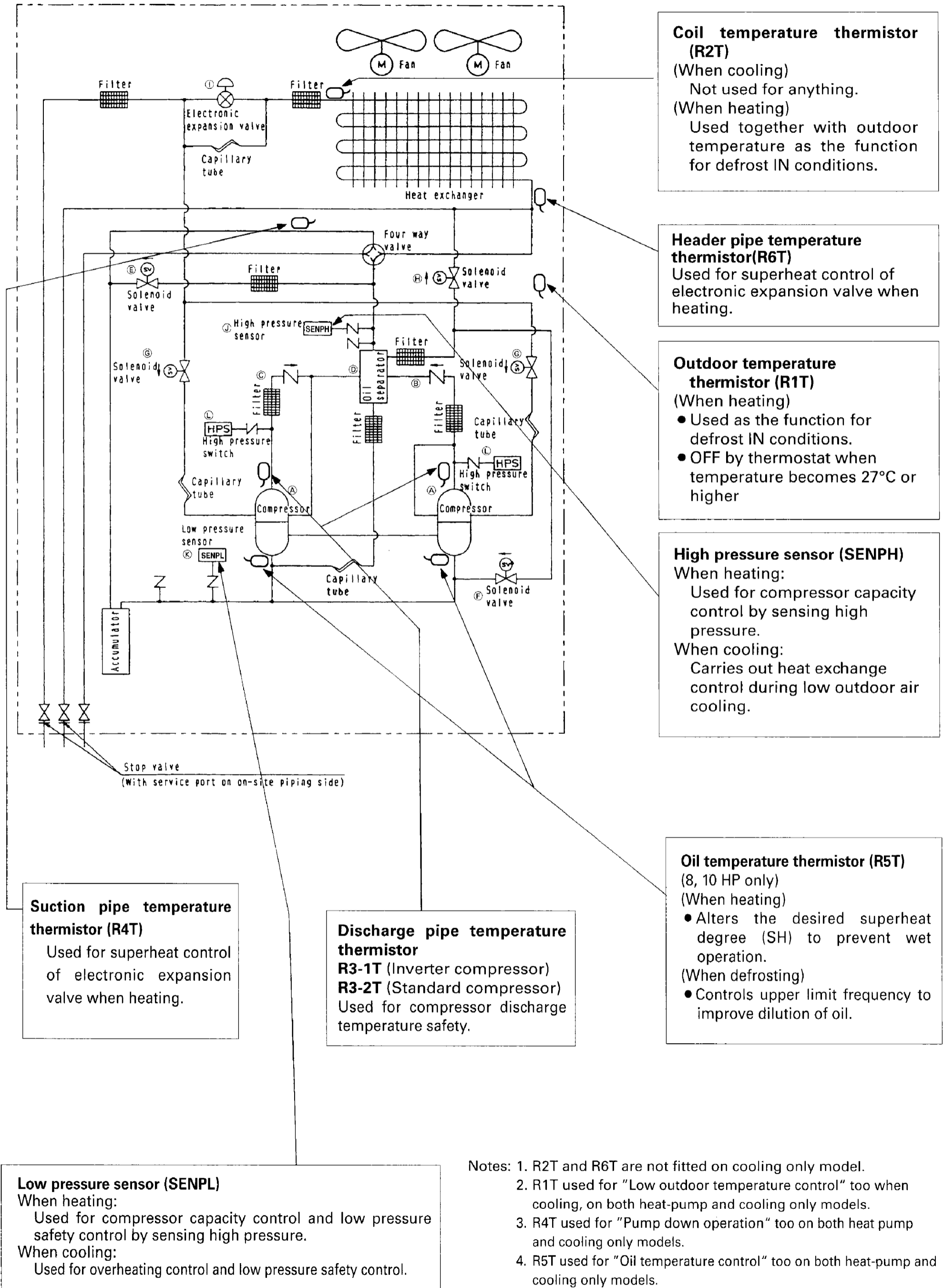

- Notes: 1. R2T and R6T are not fitted on cooling only model.  
 2. R1T used for "Low outdoor temperature control" too when cooling, on both heat-pump and cooling only models.  
 3. R4T used for "Pump down operation" too on both heat pump and cooling only models.  
 4. R5T used for "Oil temperature control" too on both heat-pump and cooling only models.



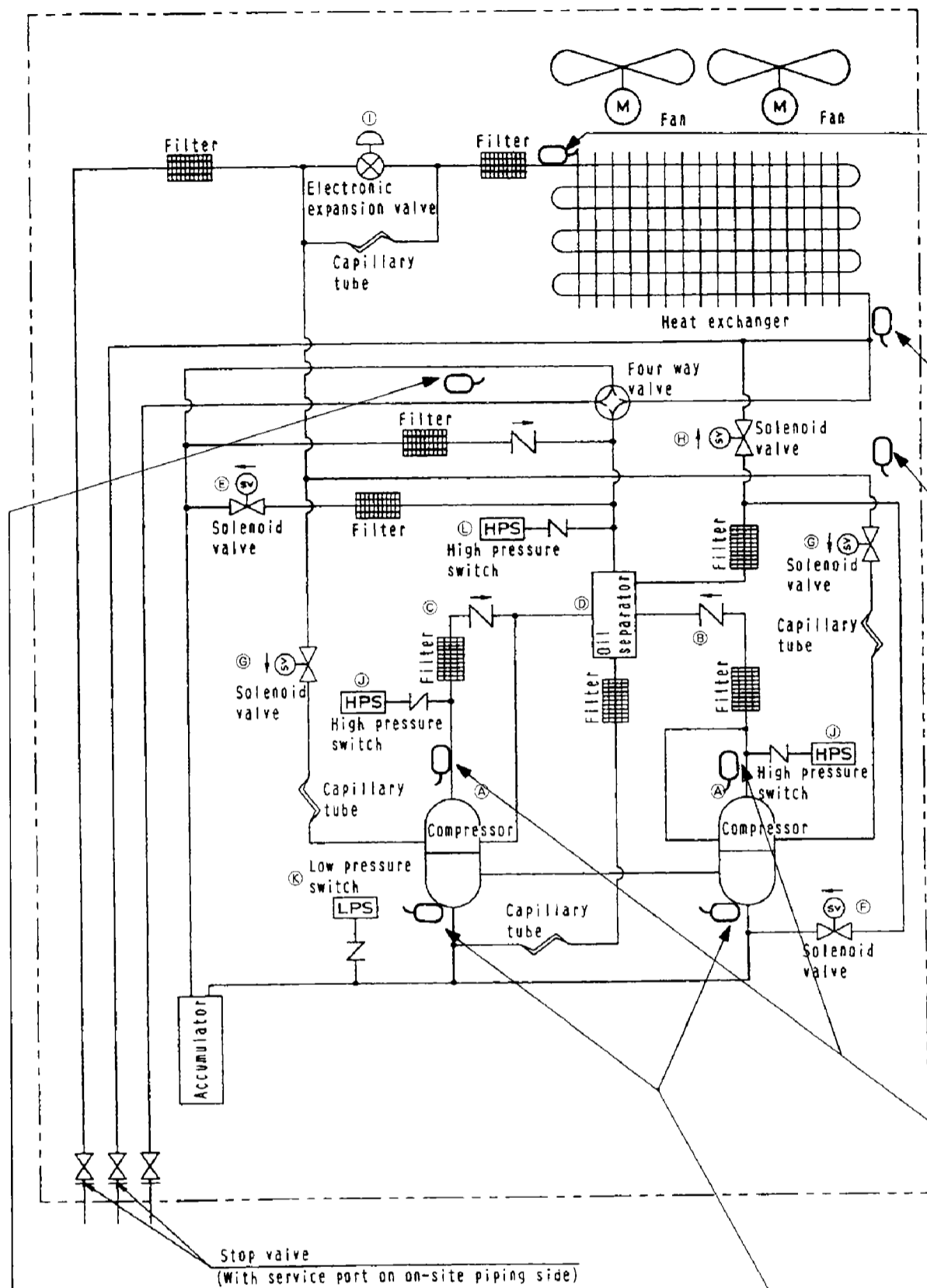

**Coil temperature thermistor (R2T)**  
 (When cooling)  
 Not used for anything.  
 (When heating)  
 Used together with outdoor temperature as the function for defrost IN conditions.

**Header pipe temperature thermistor (R6T)**  
 Used for superheat control of electronic expansion valve when heating.

**Outdoor temperature thermistor (R1T)**  
 (When heating)  
 • Used as the function for defrost IN conditions.  
 • OFF by thermostat when temperature becomes 27°C or higher

**Discharge pipe temperature thermistor**  
**R3-1T (Inverter compressor)**  
**R3-2T (Standard compressor)**  
 Used for compressor discharge temperature safety.

**Suction pipe temperature thermistor (R4T)**  
 Used for superheat control of electronic expansion valve when heating.

**Oil temperature thermistor (R5T)**  
 (8, 10 HP only)  
 (When heating)  
 • Alters the desired superheat degree (SH) to prevent wet operation.  
 (When defrosting)  
 • Controls upper limit frequency to improve dilution of oil.

- Notes:
1. R6T is not fitted on cooling only model.
  2. R1T used for "Low outdoor temperature control" too when cooling, on both heat-pump and cooling only models.
  3. R4T used for "Pump down operation" too on both heat pump and cooling only models.
  4. R5T used for "Oil temperature control" too on both heat-pump and cooling only models.

### 3. List of Safety Devices and Functional parts Setting Values



#### 1. Outdoor unit

Item	Symbol	Name		Inverter		Constant speed	
				RX(Y) 8 K	RX(Y)10K	RN(Y) 8 K	RN(Y)10K
Compressor	M 1 C	Inverter	Y 1 (kW)	JT100BDVTYE 3.5	JT100BDVTYE 3.5	—	—
			YAL (kW)	JT100BDVTYE 3.5	JT100BDVTYE 3.5	—	—
	M 2 C	Standard	Y 1 (kW)	JT100BDTYE 2.2	JT160BDTYE 3.75	JT125BDTYE JT160BDTYE 2.5+3.75	JT160BDTYE JT200BDTYE 3.75+4.0
			★RNY M 1 C M 2 C	YAL (kW)	JT100BDTYH 2.2	JT160BDTYH 3.75	JT125BDTYH JT160BDTYH 2.5+3.75
	J1HC/J2HC	Crank case heater	33W + 33W				
Safety device	R3-1T R3-2T	Compressor safety thermostat	Discharge pipe thermistor 135°C OFF				
	F 2 C	Over-current relay	HOE-20F-TRA1 10A	HOE-20F-TRA1 13A	HOE-26F-TRA1 13A 13A	HOE-26F-TRA1 13A 18A	
	Q 1 M Q 2 M	Fan motor	140W + 230W				
		Safety thermostat	Q 1 M : OFF 120°C Q 2 M : OFF 135°C				
	S 1 HP	High pressure switch	20PS688		OFF : 27.5kg/cm <sup>2</sup> ON : 20.0kg/cm <sup>2</sup>		

#### 2. Function unit

Item	Symbol	Name	BL 2 K BC 2 K	BL 3 K BC 3 K	BR 2 K	BR 3 K
				Fusible plug	FPG - 3 D 70 ~ 75 °C	

## 4. Flow of Refrigerant in Each Operating Mode

The flow of refrigerant in each mode is shown for high pressure gas or condensed liquid refrigerant by the  line, and for evaporated low pressure gas by the  line.

### (1) Heat pump model

1. Normal cooling
2. Normal heating
3. Oil return (cooling)
4. Oil return (heating)
5. Defrost
6. Oil equalizing operation (cooling)
7. Oil equalizing operation (heating step 1)
8. Oil equalizing operation (heating step 2)
9. Heating pump down residual operation
10. Refrigerant pump down operation
11. Emergency Operation for Inverter Failure (cooling)
12. Emergency Operation for Inverter Failure (heating)



(1) Heat pump model

1. Normal cooling

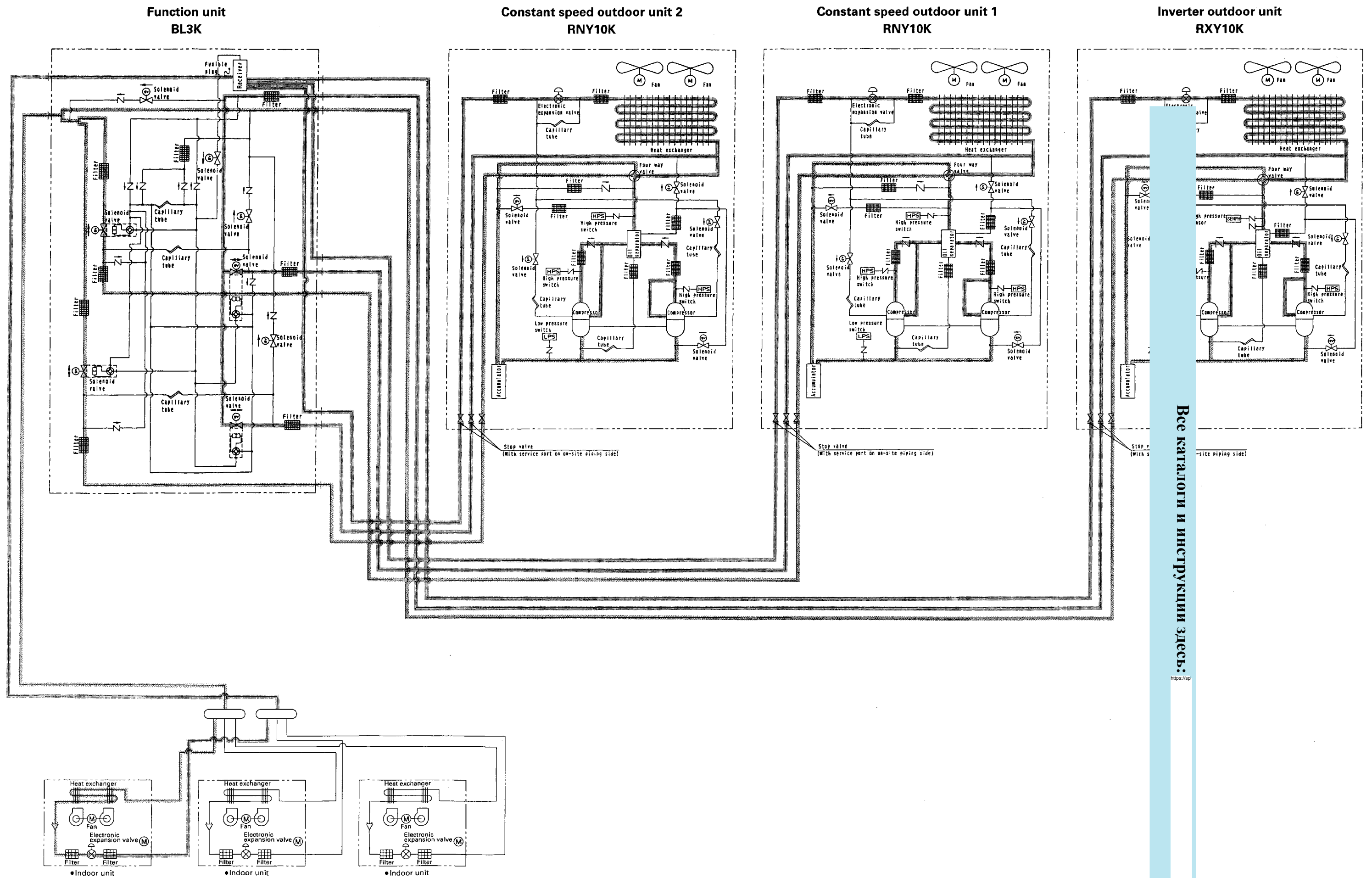

Все каталоги и инструкции здесь:  
<https://sp>

## 2. Normal heating

Function unit  
BL3K

Constant speed outdoor unit 2  
RNY10K

Constant speed outdoor unit 1  
RNY10K

Inverter outdoor unit  
RXY10K

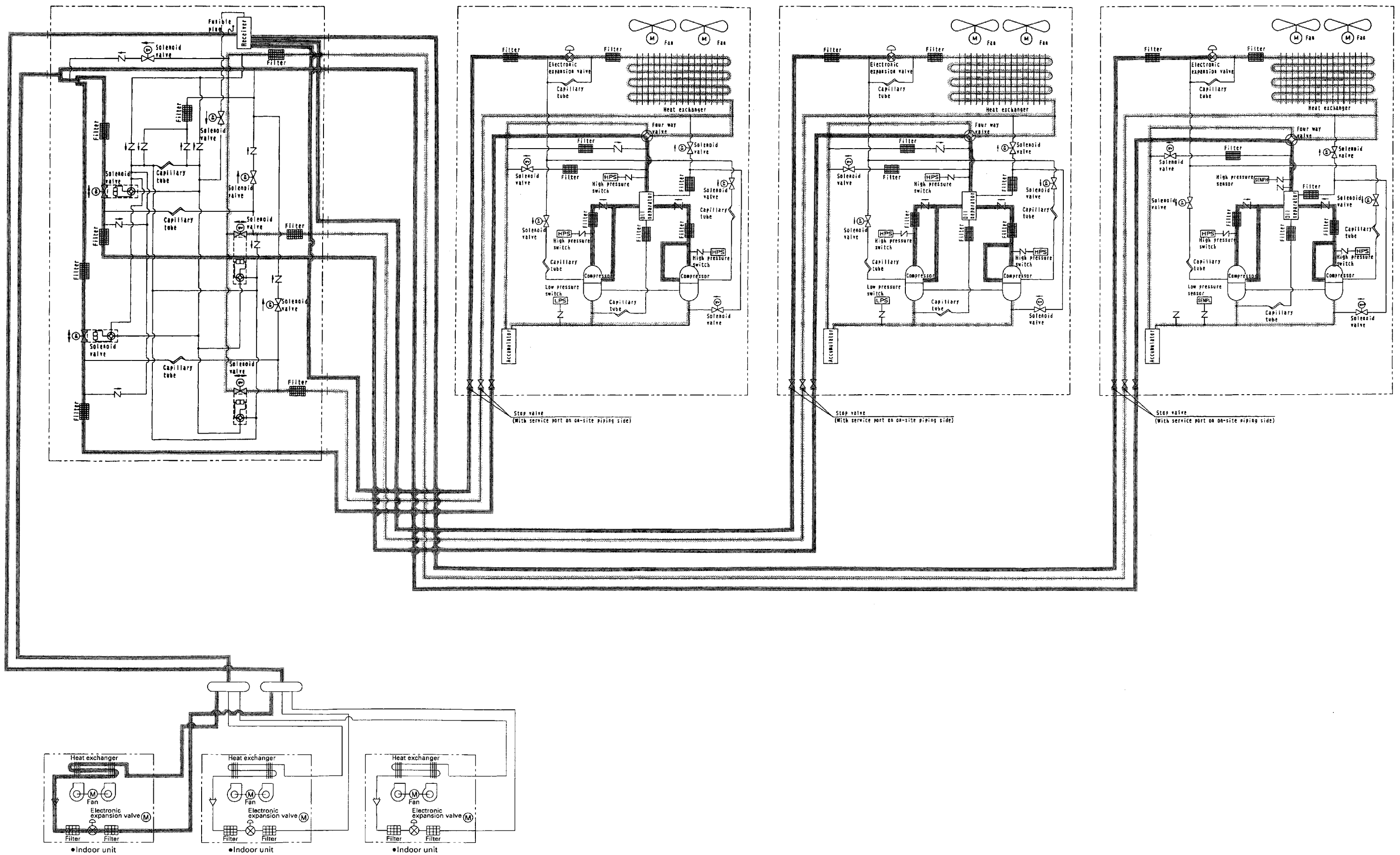

### 3. Oil return (Cooling)

Function unit  
BL3K

Constant speed outdoor unit 2  
RNY10K

Constant speed outdoor unit 1  
RNY10K

Inverter outdoor unit  
RXY10K

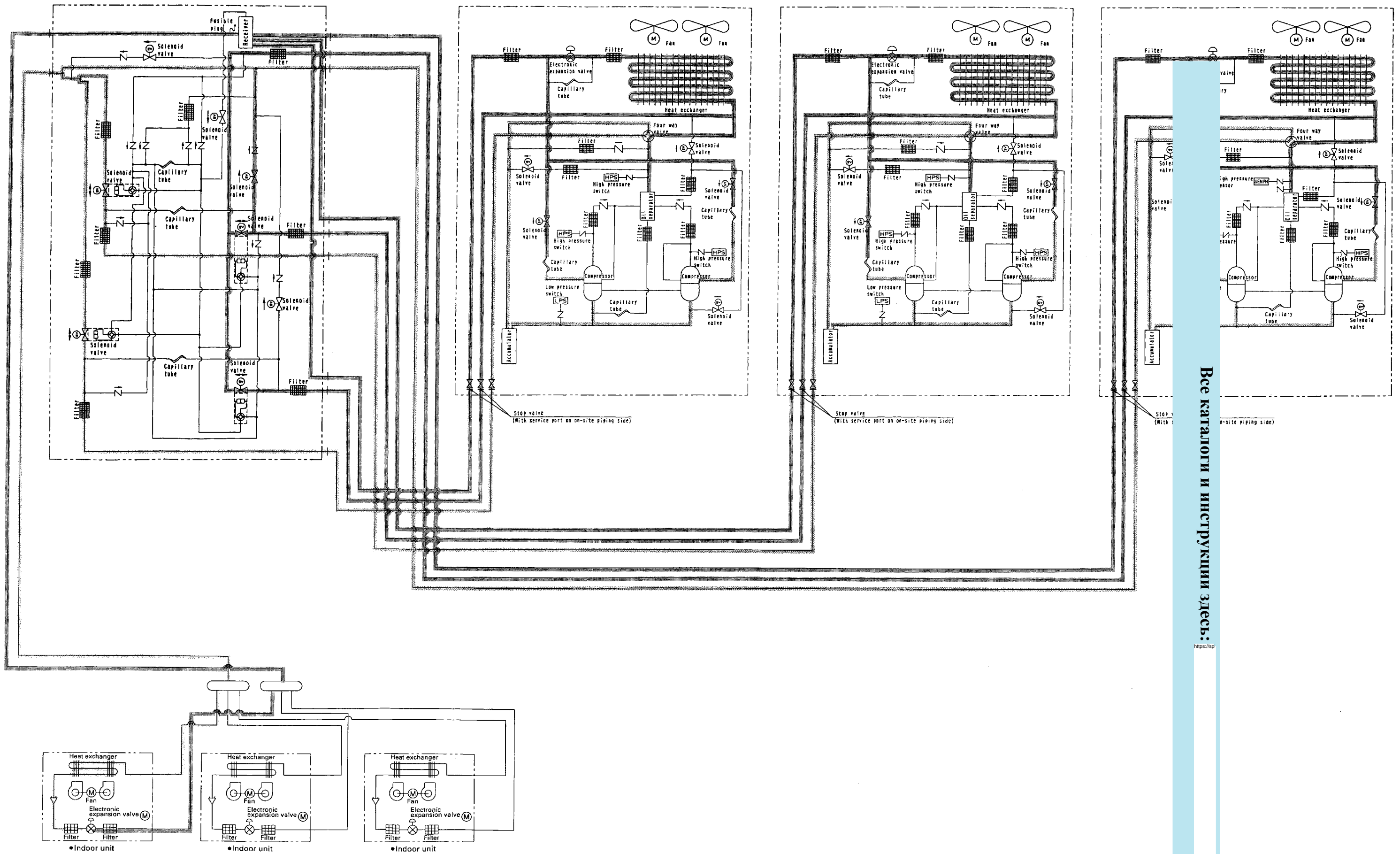

Все каталоги и инструкции здесь:

<https://sp>

#### 4. Oil return (Heating)

Function unit  
BL3K

Constant speed outdoor unit 2  
RNY10K

Constant speed outdoor unit 1  
RNY10K

Inverter outdoor unit  
RXY10K

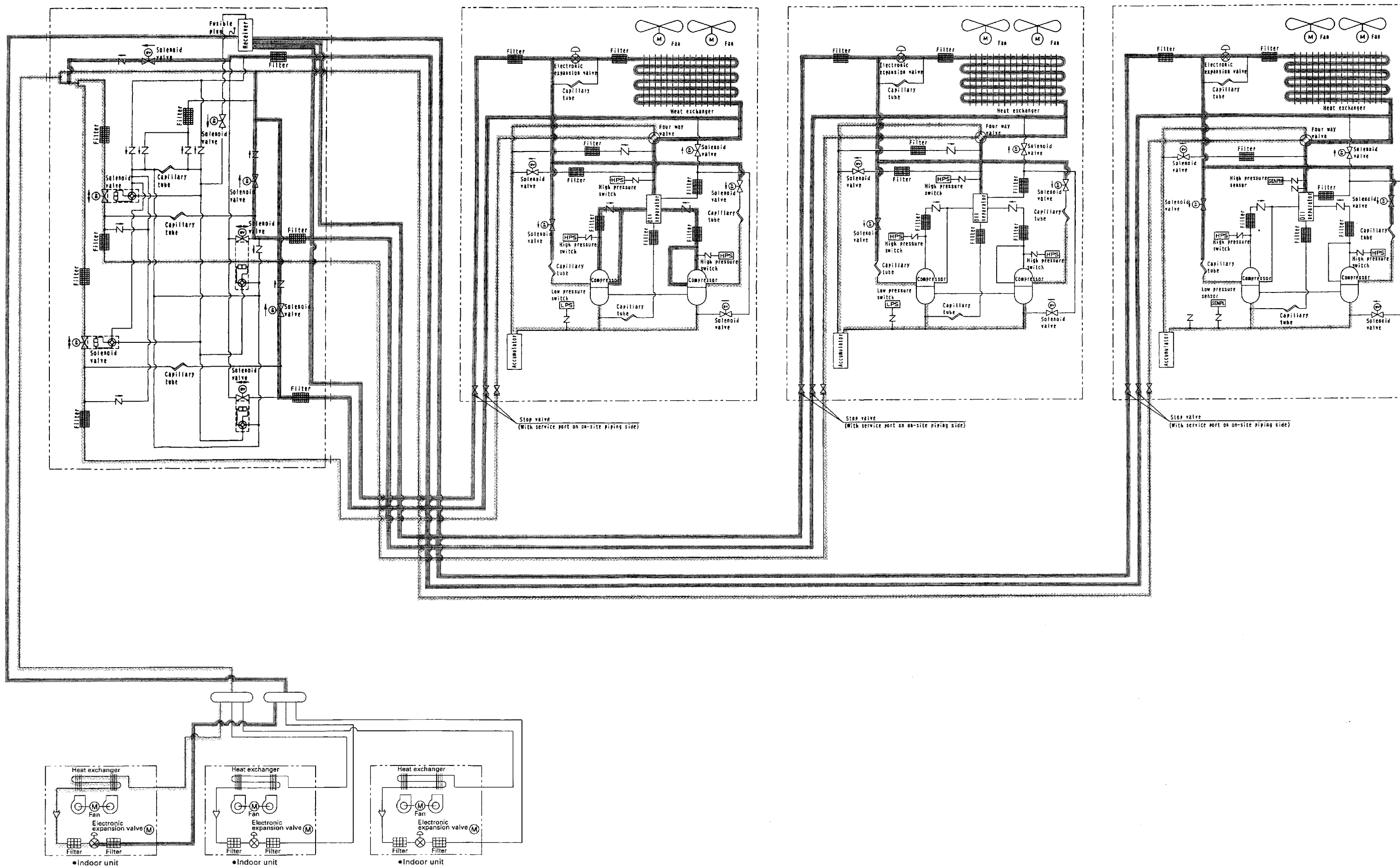



# 5. Defrost

Function unit  
BL3K

Constant speed outdoor unit 2  
RNY10K

Constant speed outdoor unit 1  
RNY10K

Inverter outdoor unit  
RXY10K

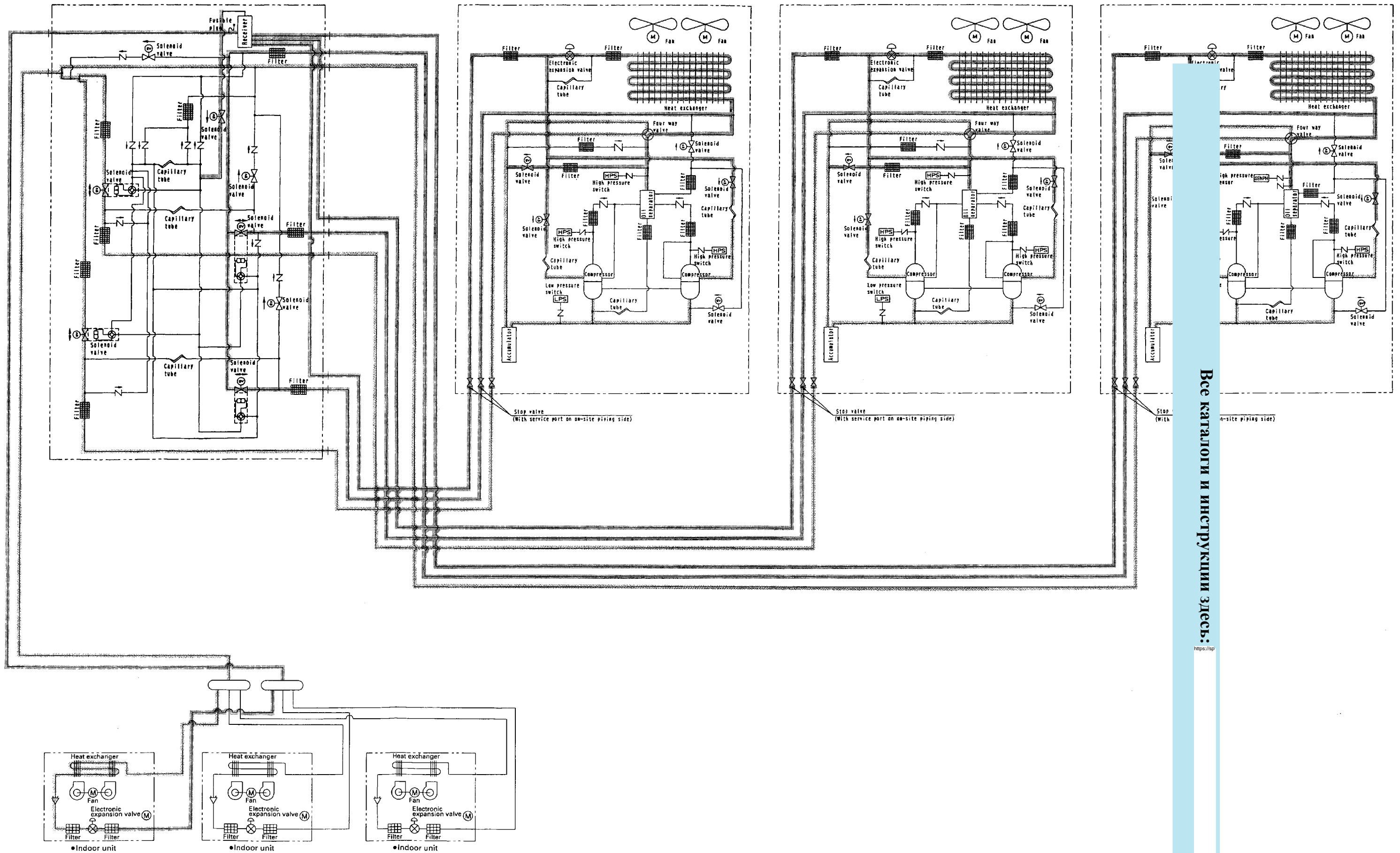

Все каталоги и инструкции здесь:

<https://sp>

## 6. Oil equalizing operation (cooling)

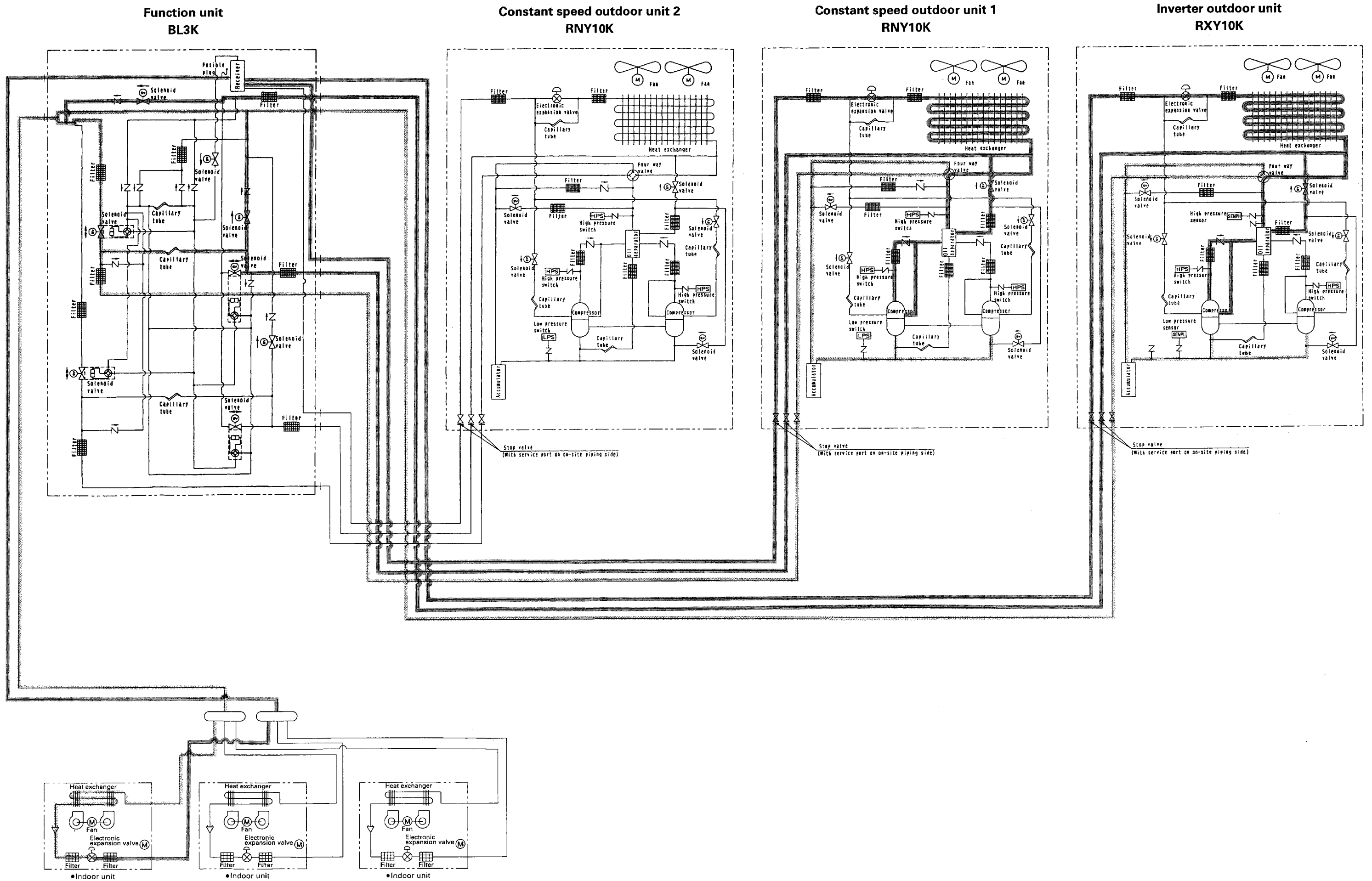

## 7. Oil equalizing operation (heating step 1)

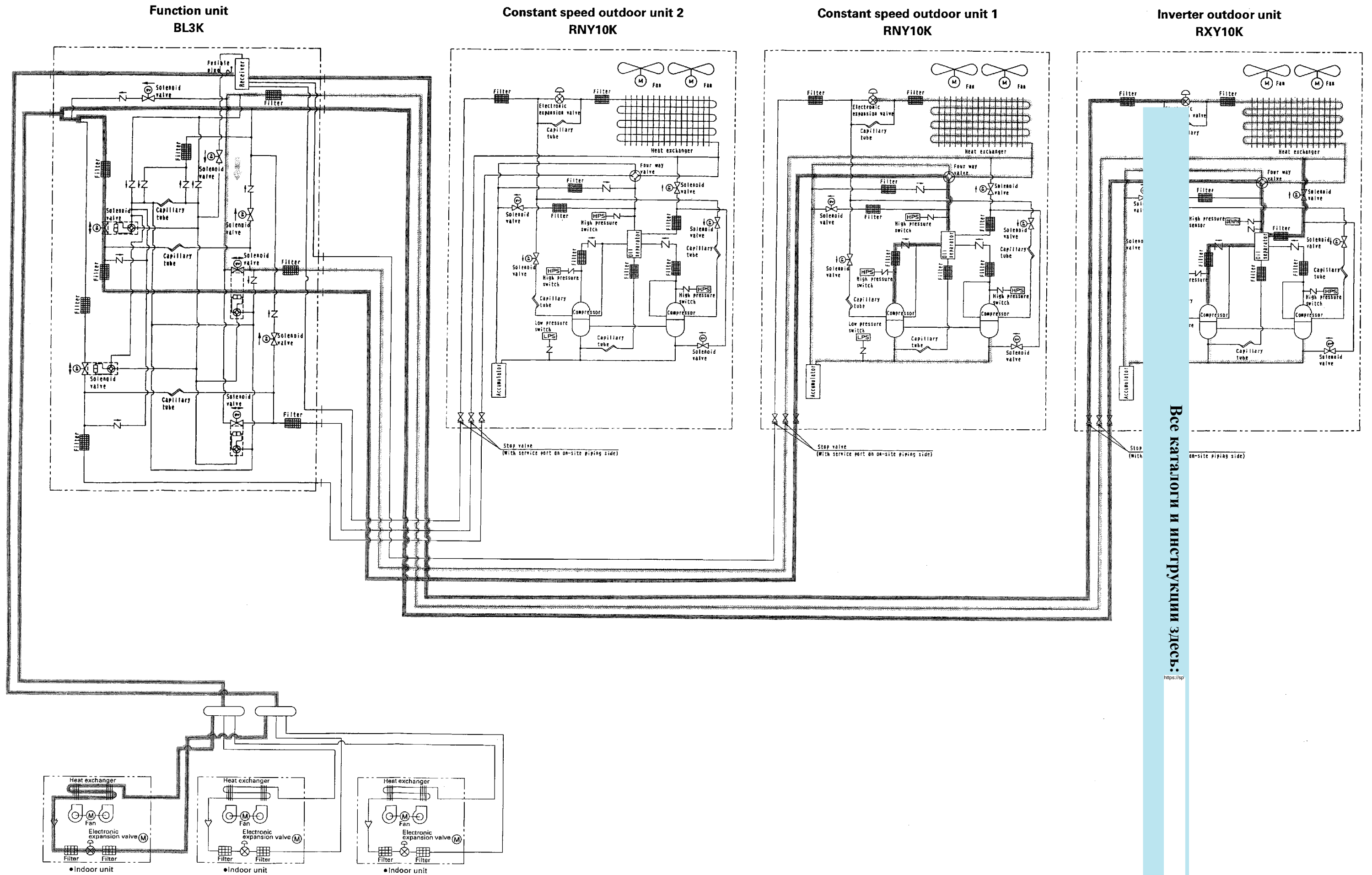

Все каталоги и инструкции здесь:

<https://sp>

## 8. Oil equalizing operation (heating step 2)

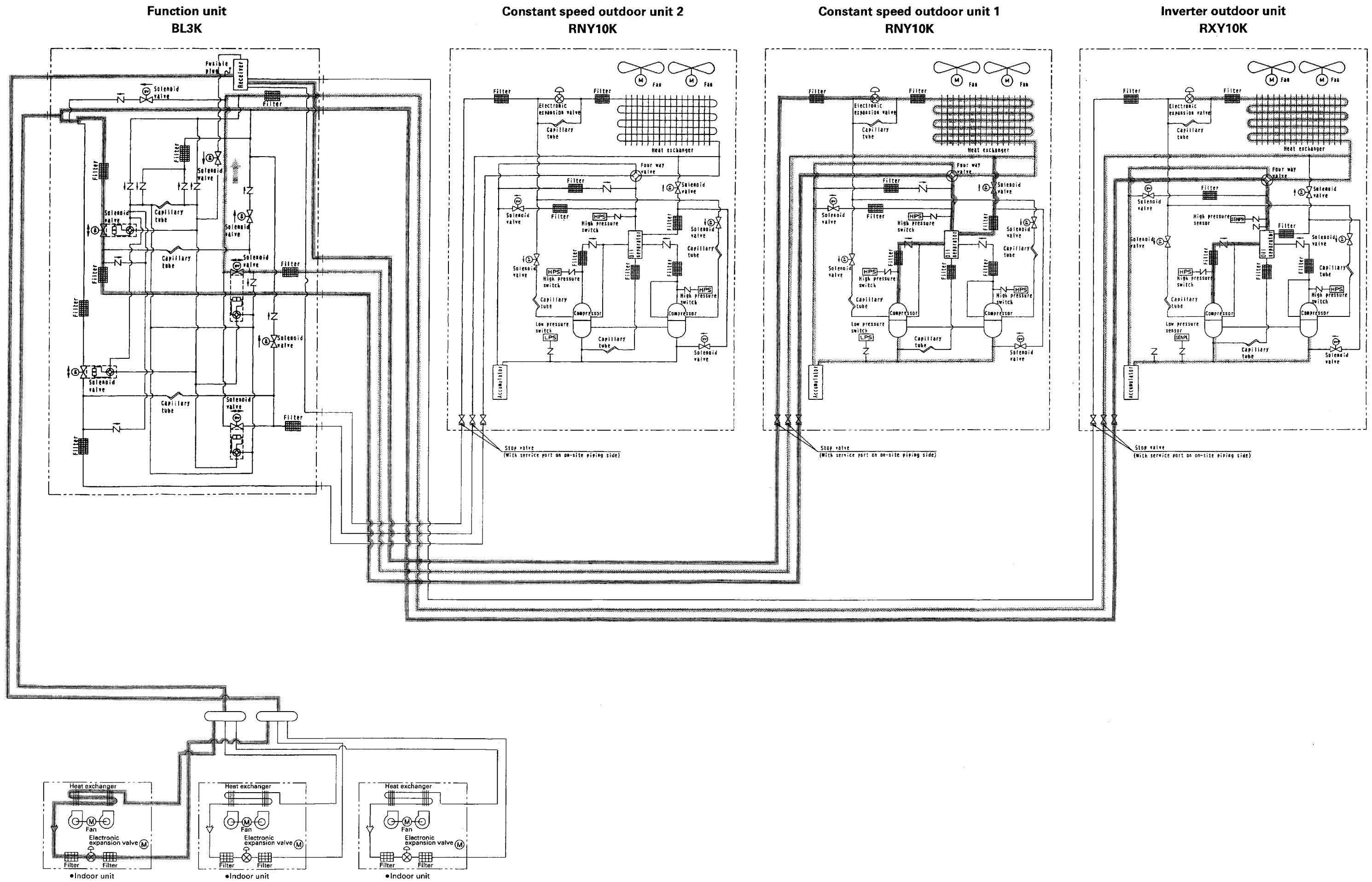

# 9. Heating pump down residual operation

Function unit  
BL3K

Constant speed outdoor unit 2  
RNY10K

Constant speed outdoor unit 1  
RNY10K

Inverter outdoor unit  
RXY10K

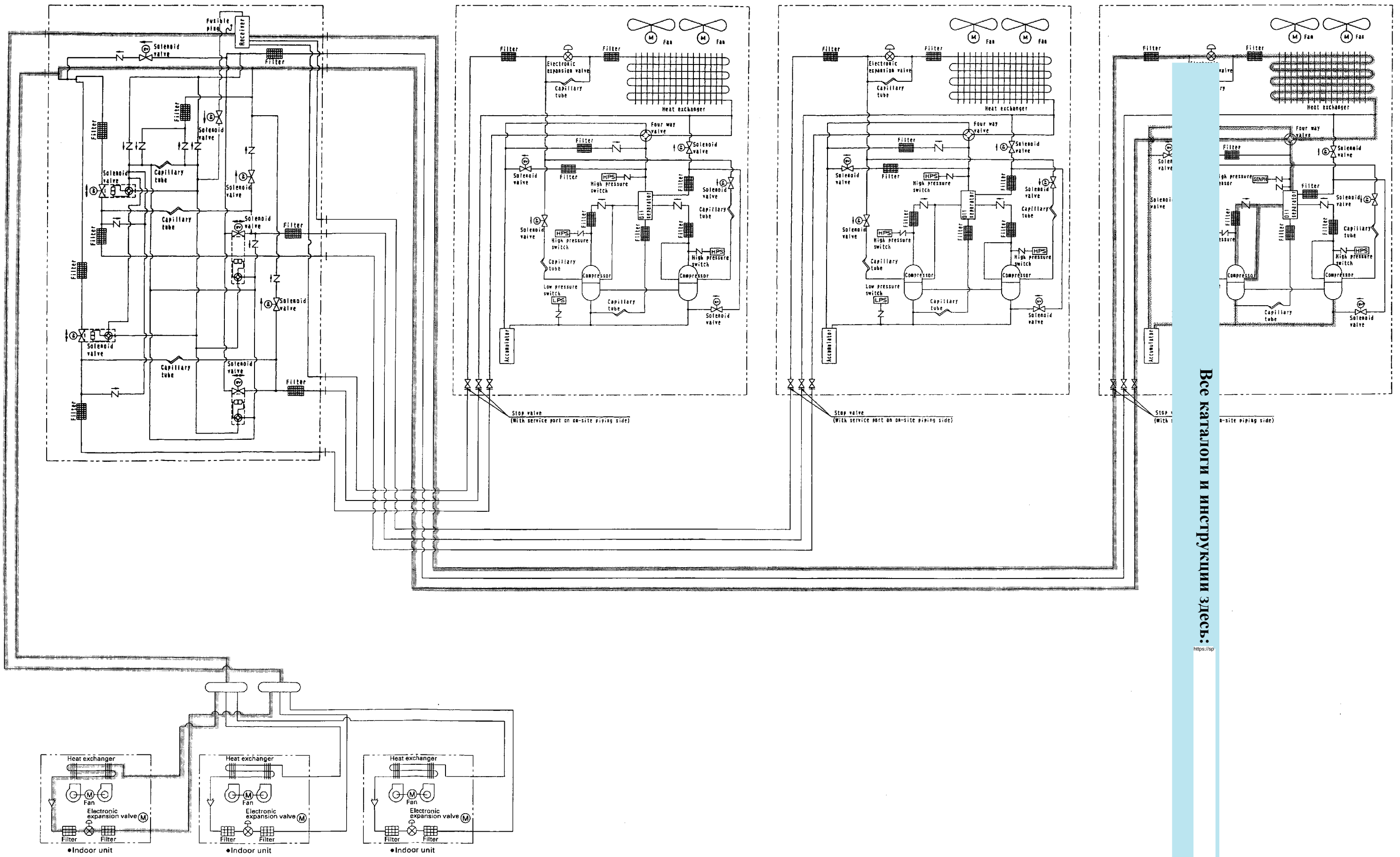

Все каталоги и инструкции здесь:

<https://sp>

10. Refrigerant pump down operation (When constant speed outdoor unit has a malfunction)

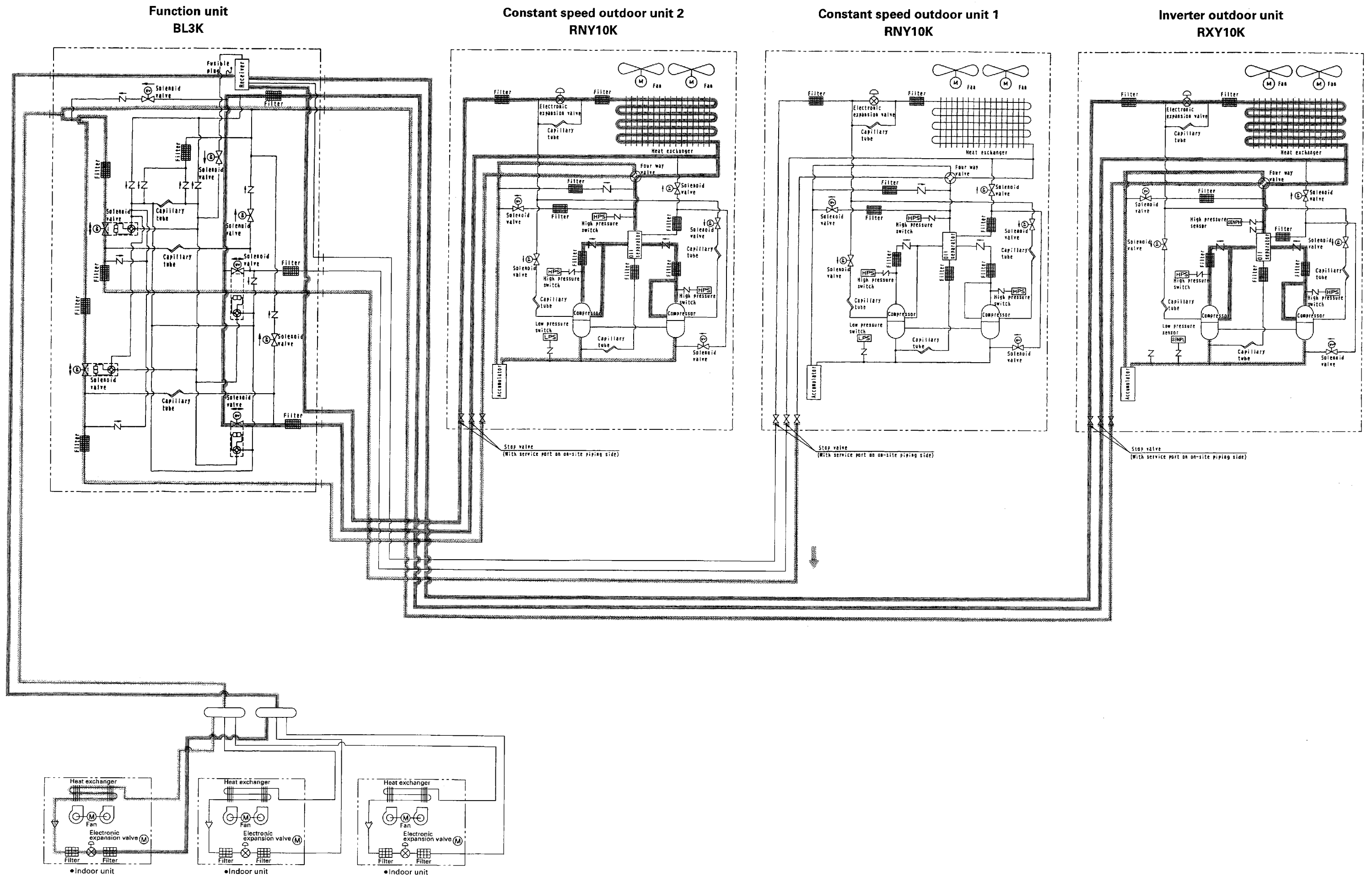

# 11. Emergency operation for Inverter failure (Cooling)

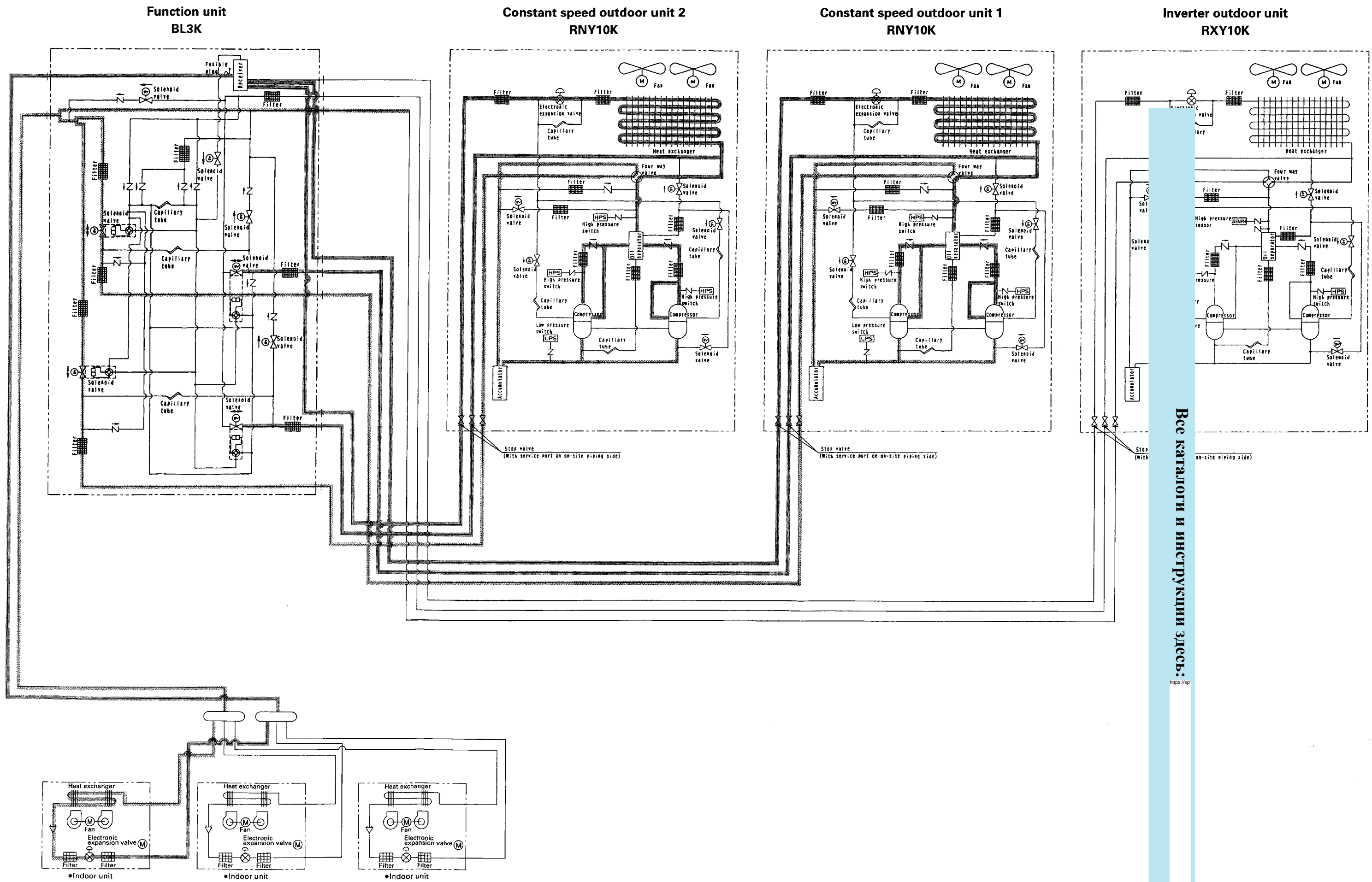

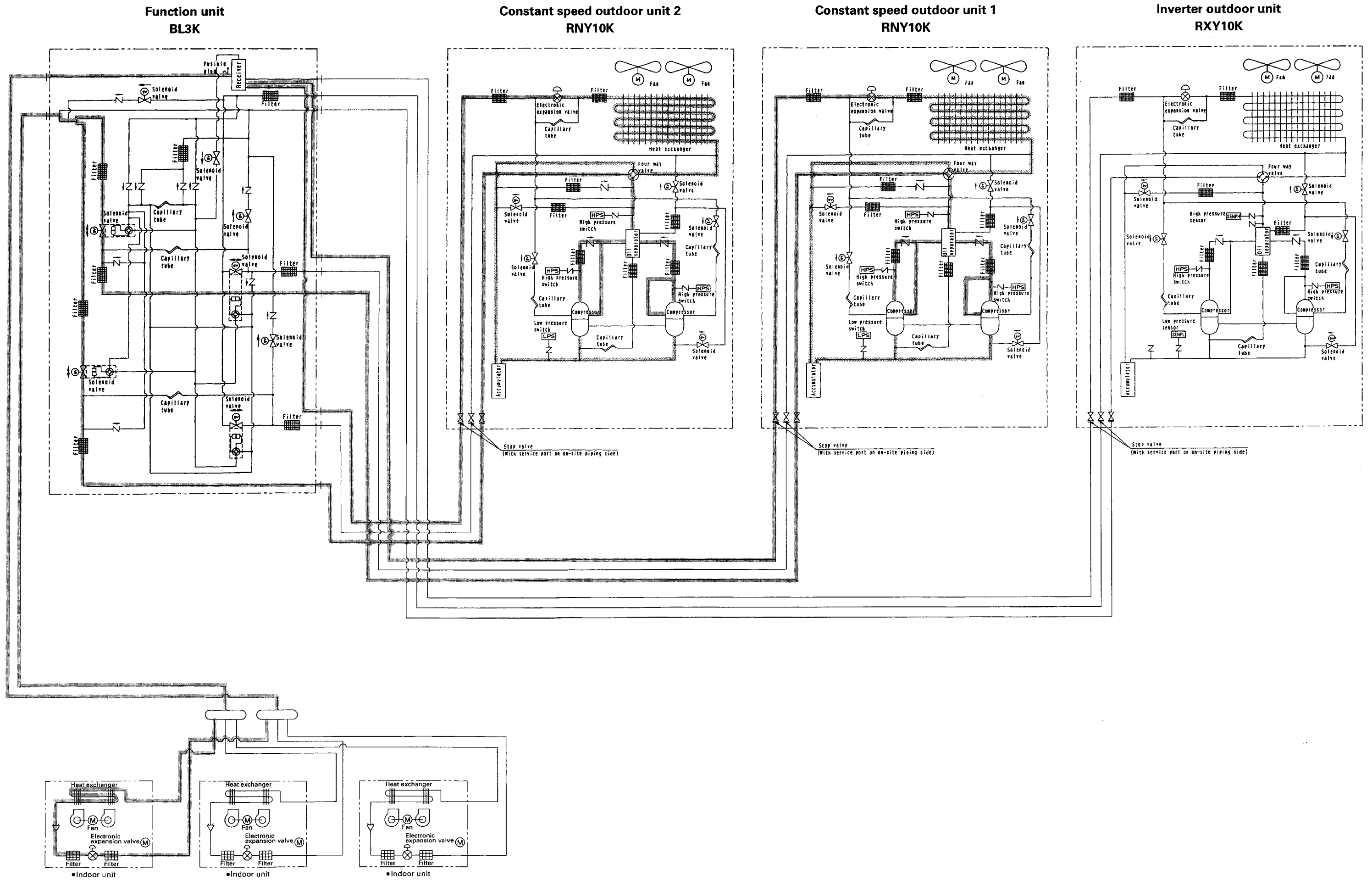

Все каталоги и инструкции здесь:  
<https://sp>

## 12. Emergency operation for Inverter failure (heating)





The flow of refrigerant in each mode is shown for high pressure gas or condensed liquid refrigerant by the  line, and for evaporated low pressure gas by the  line.

## **(2) Cooling only model**

1. Normal cooling
2. Oil return (cooling)
3. Oil equalizing operation (cooling)
4. Refrigerant pump down operation
5. Emergency Operation for Inverter Failure (cooling)



(2) Cooling only model

1. Normal cooling

Function unit  
BC3K

Constant speed outdoor unit 1  
RN10K

Constant speed outdoor unit 2  
RN10K

Inverter outdoor unit  
RX10K

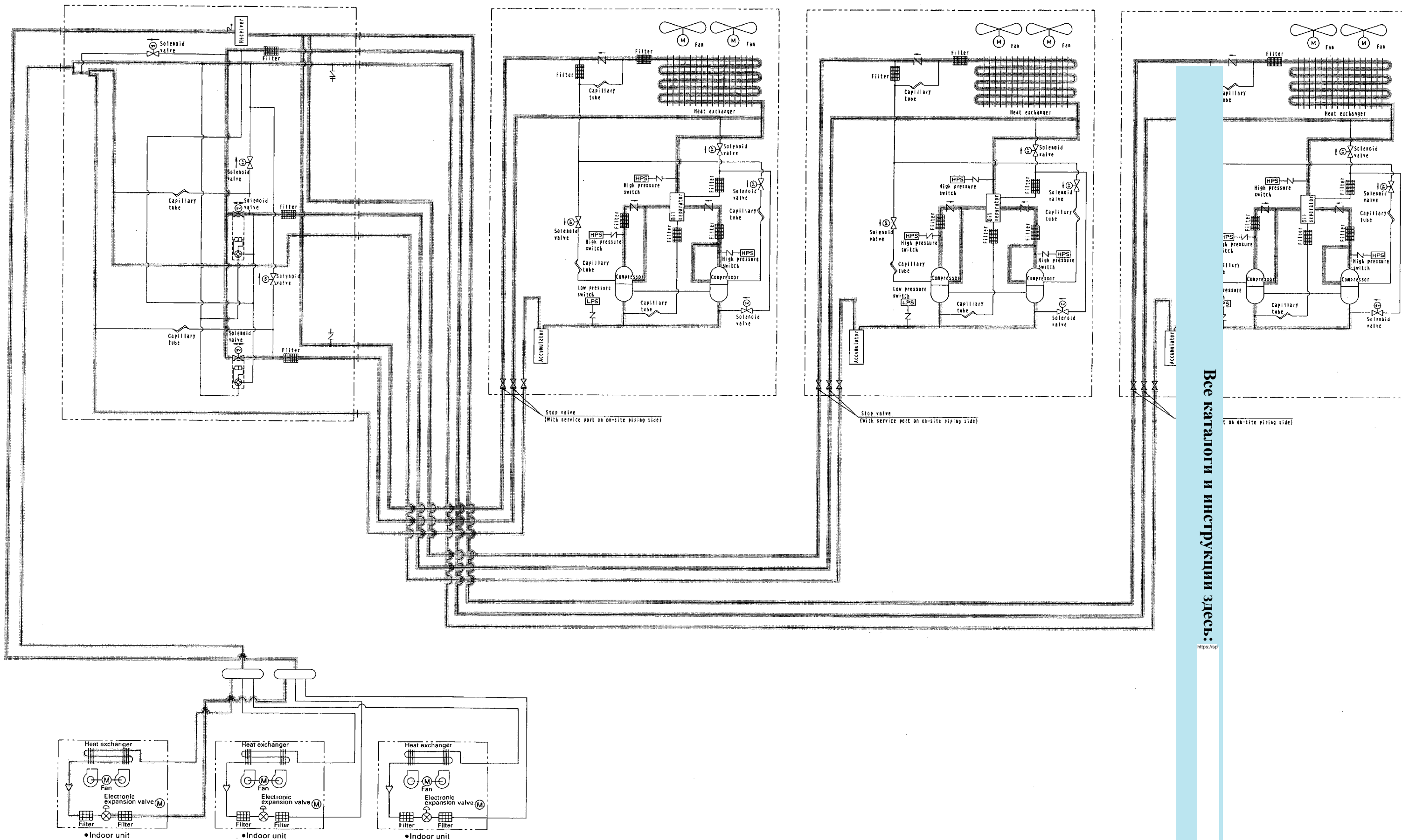

Все каталоги и инструкции здесь:

<https://sp>

## 2. Oil return (Cooling)

Function unit  
BC3K

Constant speed outdoor unit 1  
RN10K

Constant speed outdoor unit 2  
RN10K

Inverter outdoor unit  
RX10K

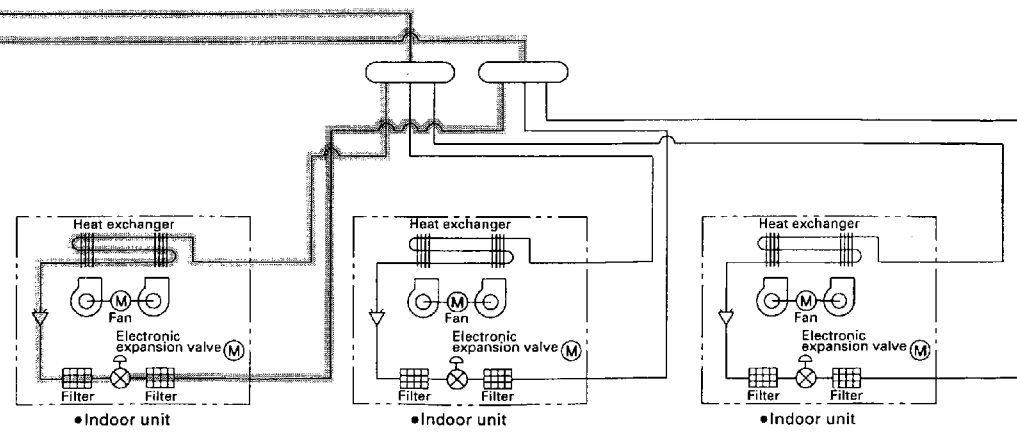
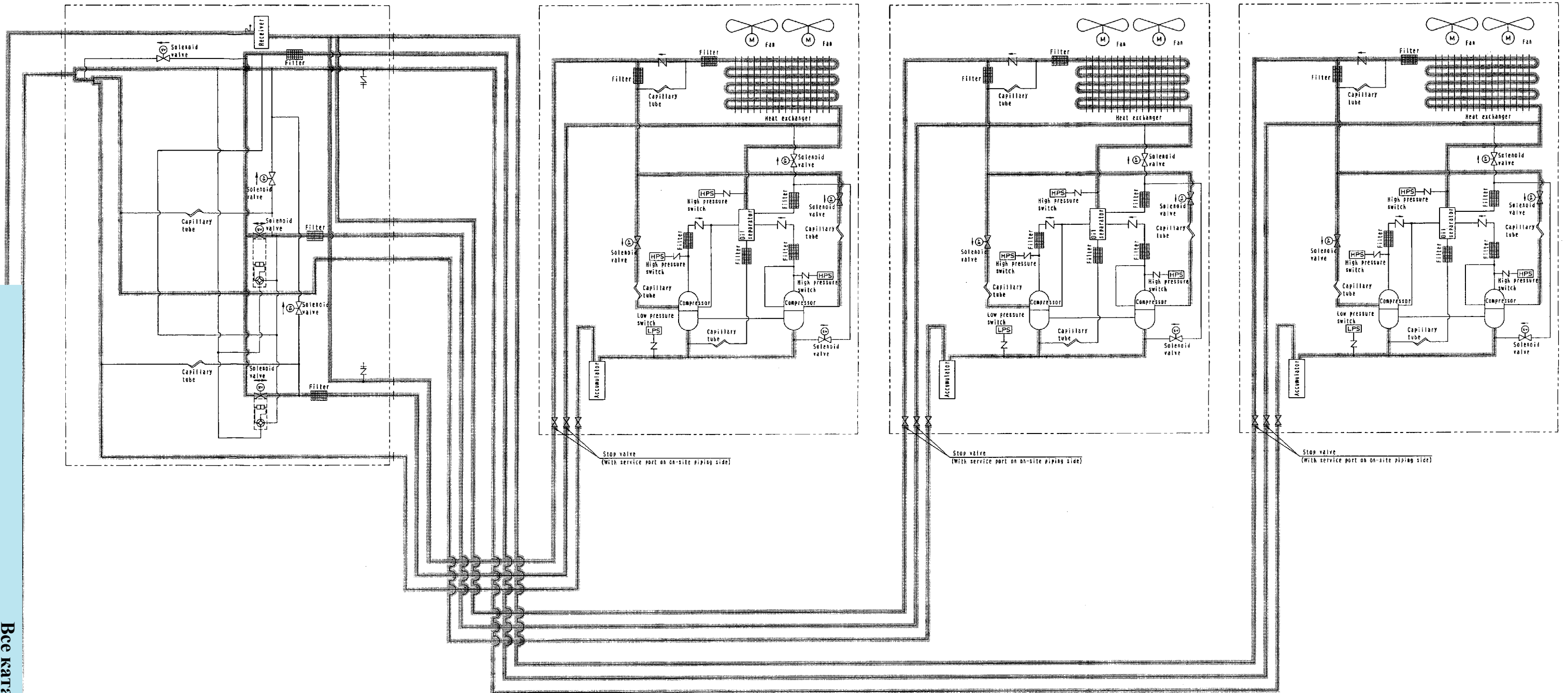

### 3. Oil equalizing operation (Cooling)

Function unit  
BC3K

Constant speed outdoor unit 1  
RN10K

Constant speed outdoor unit 2  
RN10K

Inverter outdoor unit  
RX10K

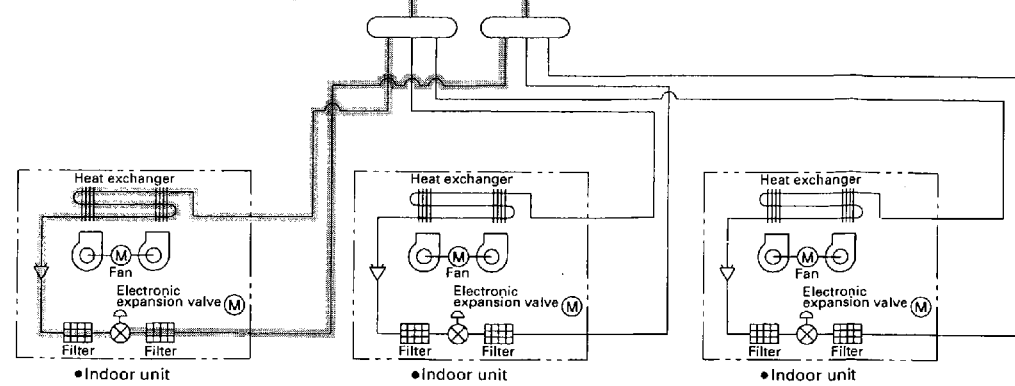
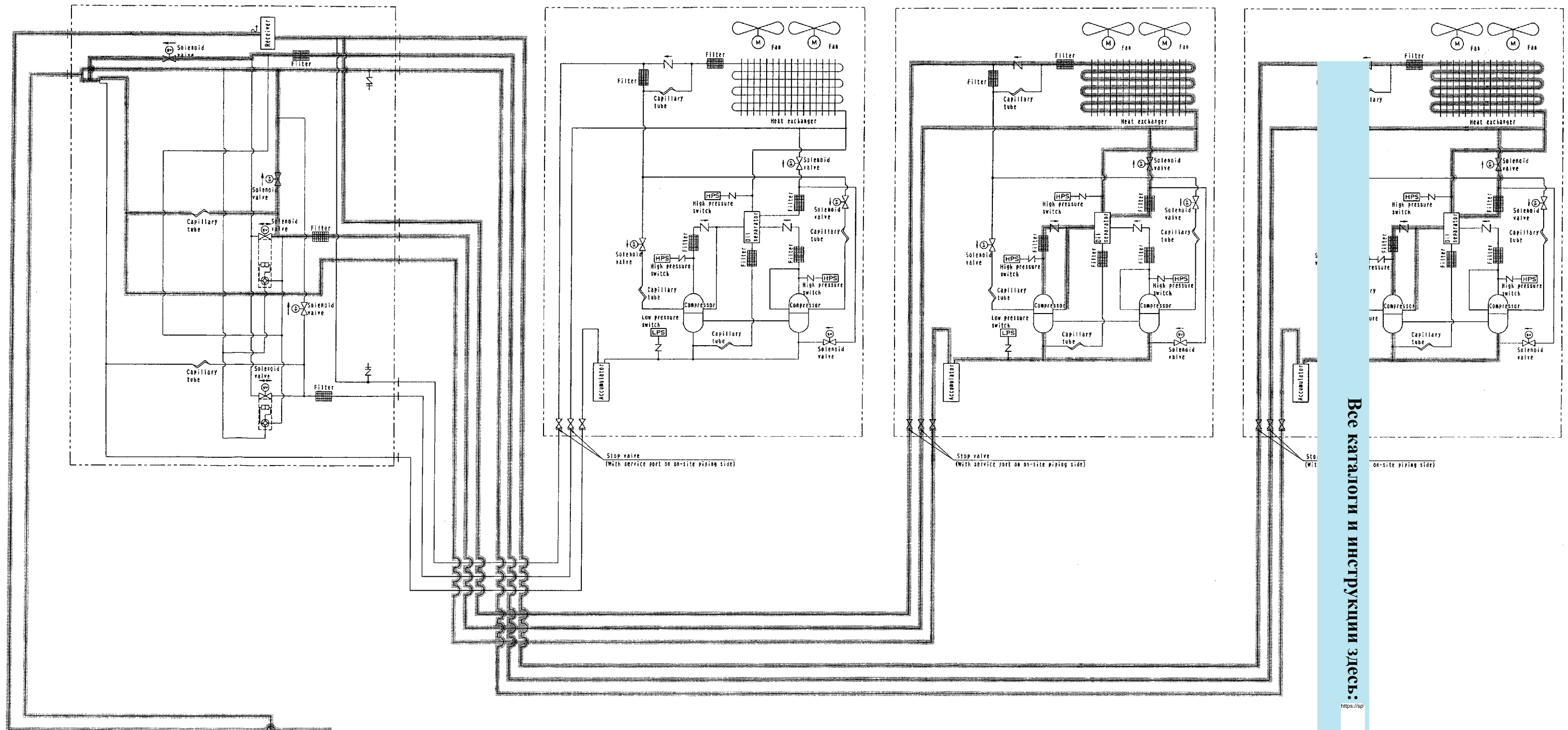

Все каталоги и инструкции здесь:  
<https://sp>

#### 4. Refrigerant pump down operation

Function unit  
BC3K

Constant speed outdoor unit 1  
RN10K

Constant speed outdoor unit 2  
RN10K

Inverter outdoor unit  
RX10K

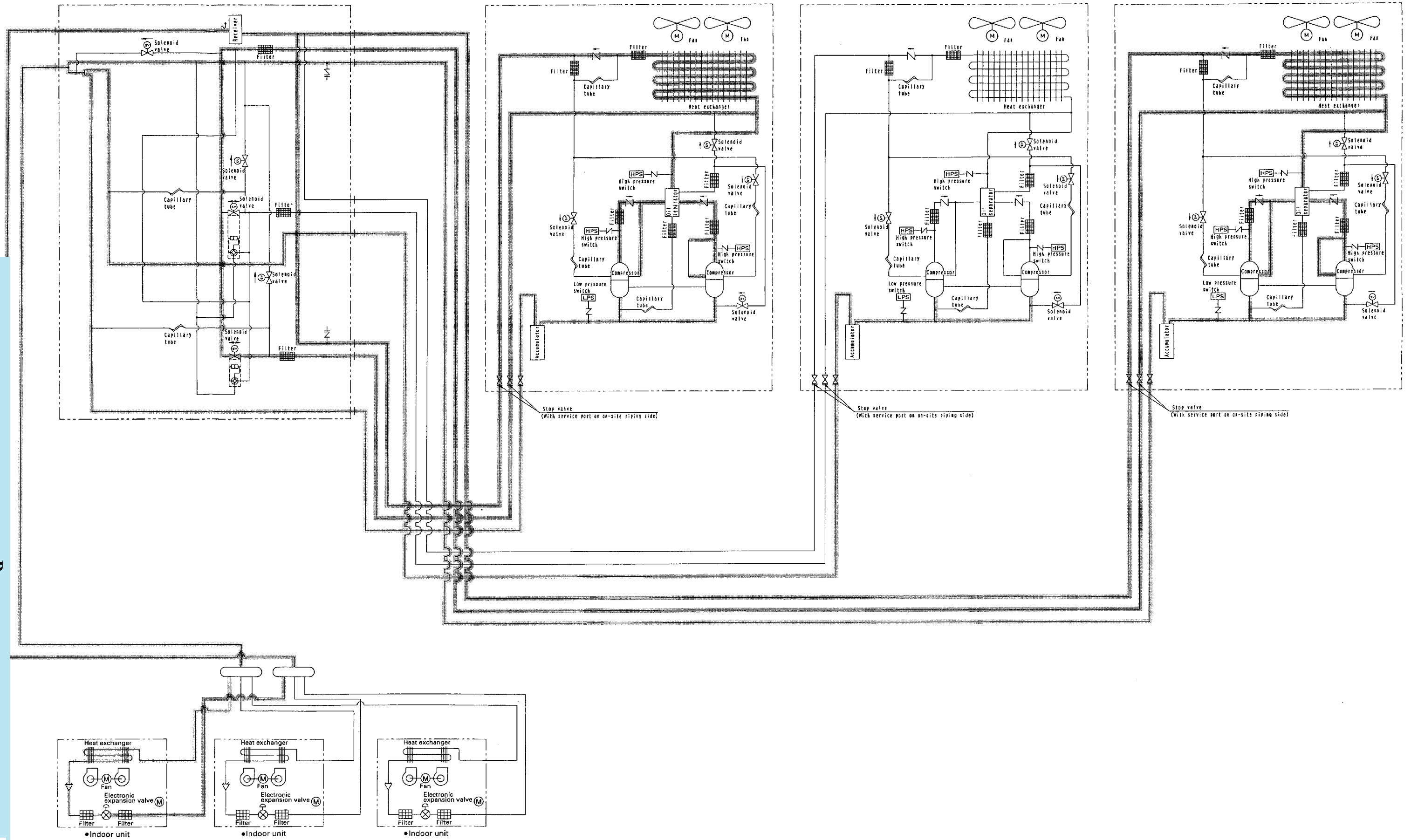

## 5. Emergency operation for Inverter failue (Cooling)

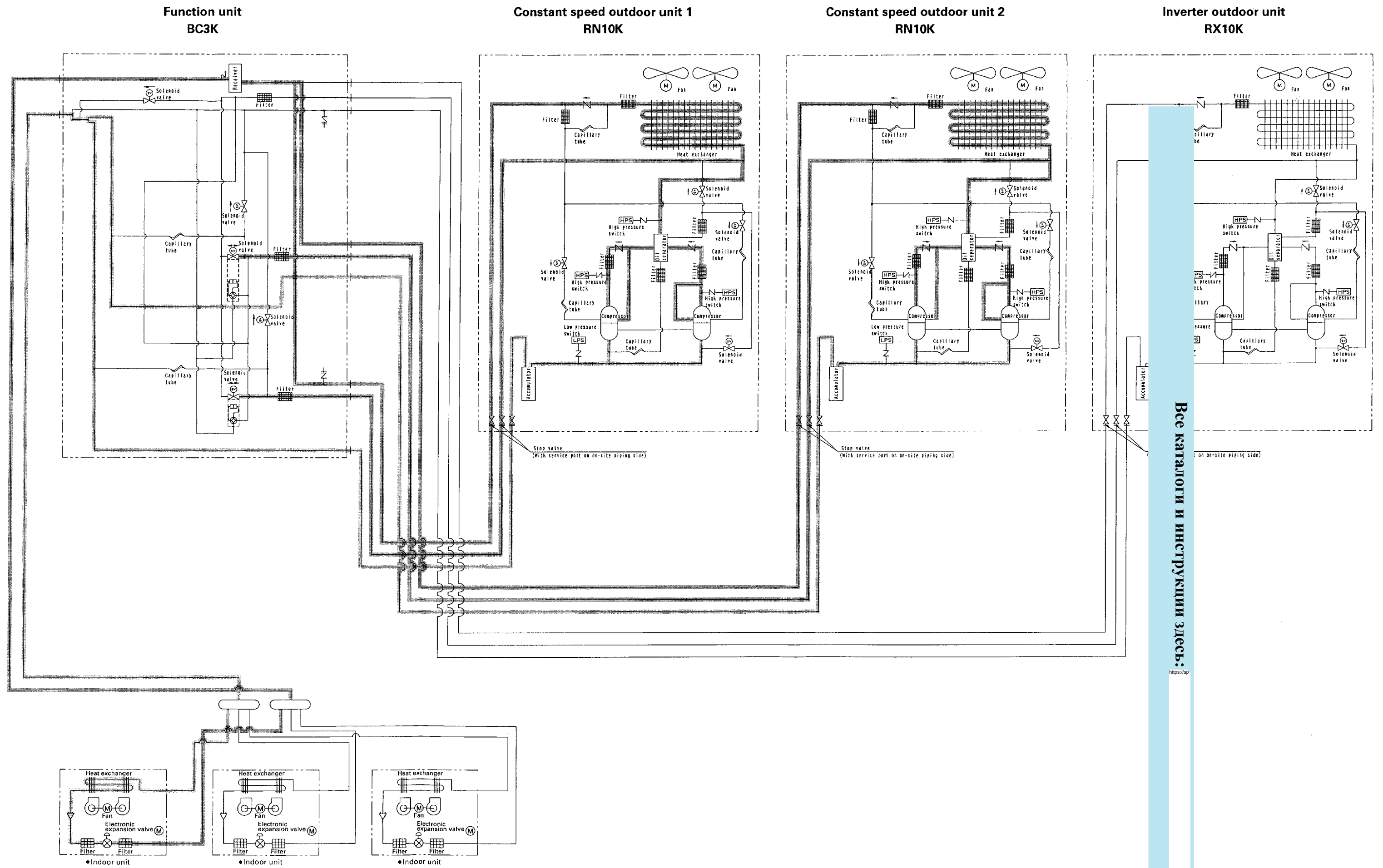

Все каталоги и инструкции здесь:

<https://sp>





## 5. Outline of Control

### 1. Starting Control

#### Soft start

Starts inverter type by low operation frequency in order to prevent refrigerant pump down when the compressor starts for both cooling and heating.

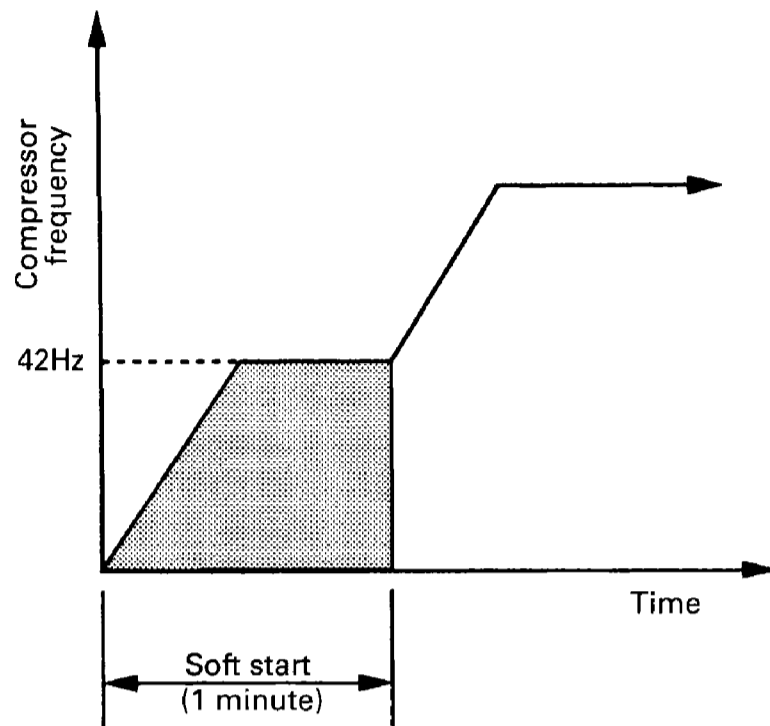

INV outdoor unit	Frequency at start	42Hz + OFF
	Hot gas bypass	ON
STD outdoor unit	Liquid injection	ON
	Hot gas bypass	ON

※ INV : Inverter, STD : Standard  
Herein after we indicate  
INV for inverter and STD for standard.

<In case of cooling only system>

INV outdoor unit	Frequency at start	42Hz + OFF
	Liquid injection	ON
Function unit (BC)	Solenoid valve Y5, Y6, Y7	ON

## Cooling start following layup

When starting for the first time after turning on the power, temporarily starts all outdoor units in order to discharge refrigerant from the low pressure line and accumulator when outdoor temperature is low.

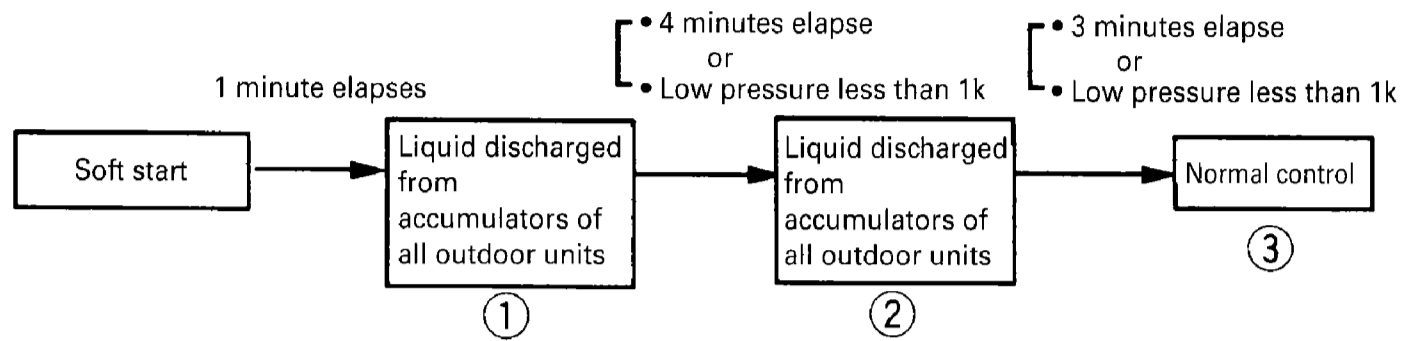

### Outdoor unit operation during cooling accumulation start

	①			②			③ ( Initial settings )		
	INV outdoor unit	STD outdoor unit 1	STD outdoor unit 2	INV outdoor unit	STD outdoor unit 1	STD outdoor unit 2	INV outdoor unit	STD outdoor unit 1	STD outdoor unit 2
Compressor	48+OFF	ON+OFF	ON+OFF	48+OFF	ON+OFF	ON+OFF	48+OFF	OFF	OFF
Outdoor fan	Control by high pressure						H + O N		
Outdoor EEV	2000PLS	2000PLS	2000PLS	2000PLS	2000PLS	2000PLS	2000PLS	0PLS	0PLS
Hot gas bypass	ON	ON	ON	ON	OFF	OFF	ON	OFF	OFF
Hot gas bypass for equalizing pressure	OFF	OFF	OFF	OFF	OFF	OFF	OFF	OFF	OFF
Injection	No1	Td safety control	Td safety control	Td safety control	Td safety control	Td safety control	Td safety control	OFF	OFF
	No2	OFF	OFF	OFF	OFF	OFF	OFF	OFF	OFF
Oil control solenoid valve	OFF	OFF	OFF	OFF	OFF	OFF	OFF	OFF	OFF

※ EEV : Herein after we indicate EEV for Electronic expansion valve.

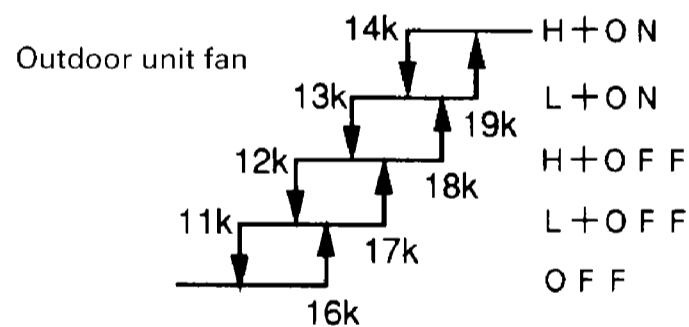

<In case of cooling only system>

### Outdoor unit and function unit operation during cooling accumulation start

	①			②			③ (Initial settings)		
	INV outdoor unit	STD outdoor unit 1	STD outdoor unit 2	INV outdoor unit	STD outdoor unit 1	STD outdoor unit 2	INV outdoor unit	STD outdoor unit 1	STD outdoor unit 2
Compressor	48 + OFF	ON + OFF	ON + OFF	48 + OFF	ON + OFF	ON + OFF	48 + OFF	OFF	OFF
Outdoor fan	Control by high pressure						H + ON		
Hot gas bypass for equalizing pressure	OFF	OFF	OFF	OFF	OFF	OFF	OFF	OFF	OFF
Injection	No.1	Td safety control	Td safety control	Td safety control	Td safety control	Td safety control	Td safety control	OFF	OFF
	No.2	OFF	OFF	OFF	OFF	OFF	OFF	OFF	OFF
Oil control solenoid valve	OFF	OFF	OFF	OFF	OFF	OFF	OFF	OFF	OFF
Function unit's solenoid valve	Y5-ON	Y6-ON	Y7-ON	Y5-ON	Y6-OFF	Y7-OFF	Y5-ON	Y6-OFF	Y7-OFF

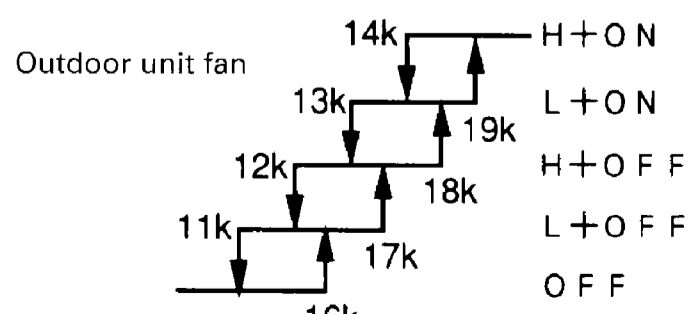

## Heating pump down start (Except for cooling only system)

When starting within 3 hours after the compressor stops and pump down residual operation has been executed before the compressor was stopped, after completing soft start, compressor operating frequency is held to (60 Hz + OFF) ~ (96 Hz + OFF), the heat exchange pressure equalizing piping solenoid for standard types 1 and 2 is opened, and the refrigerant in the accumulator of the inverter type is discharged. The frequency is further maintained at (30 Hz + OFF) for 1 minute, refrigerant in outdoor unit heat exchangers is evaporated by shutting off hot gas, and operation switches to normal control.

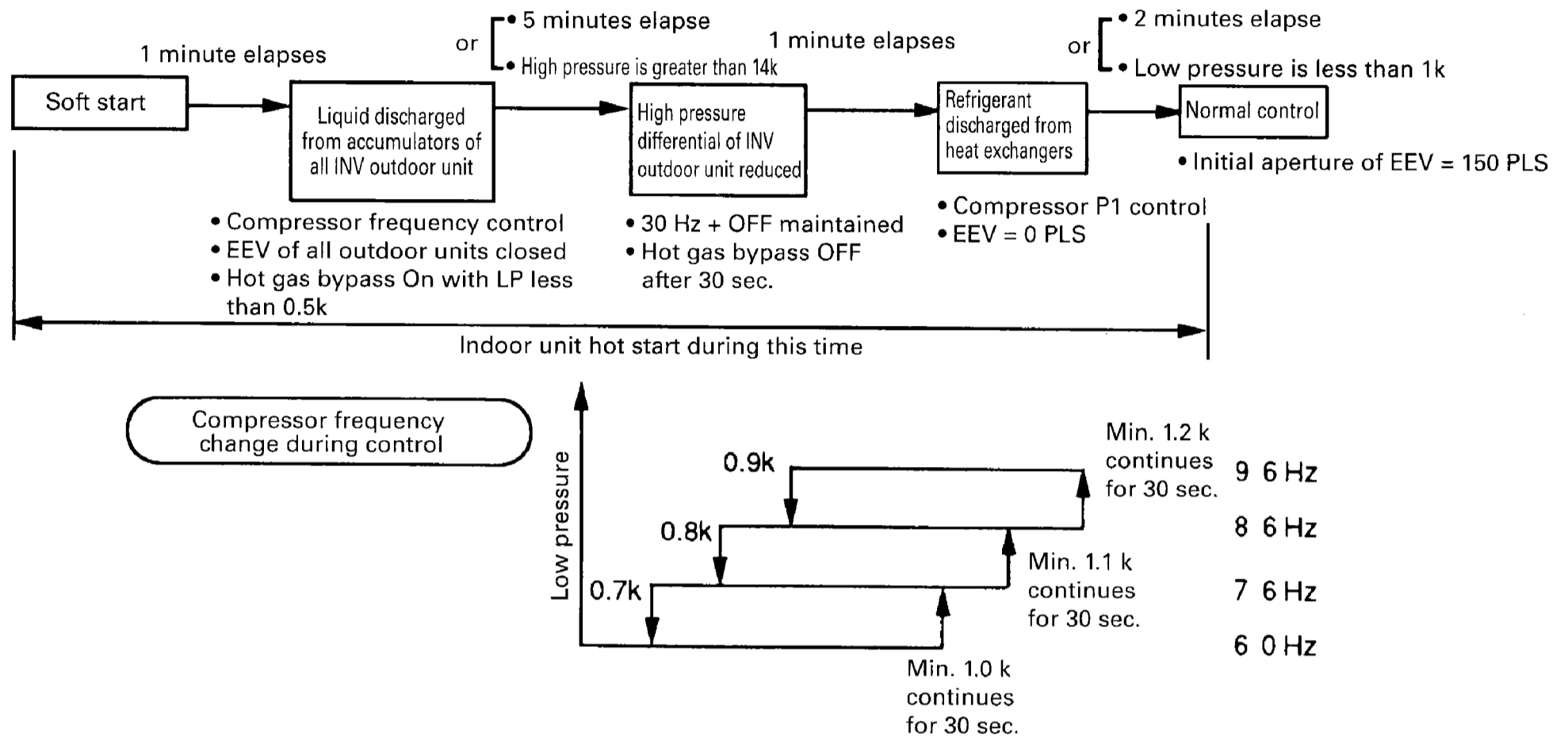

## Heating power on start (Except for cooling only system)

Discharge refrigerant collected in the low pressure side to protect the compressor when starting for the first time within 6 hours after turning off the power.

After completing soft start, compressor operating frequency is held to (60 Hz + OFF) ~ (96 Hz + OFF). After the refrigerant in the pressure equalizing line and accumulator of the inverter type is discharged, the standard compressors start in sequence, and refrigerant is discharged from each respective low pressure line.

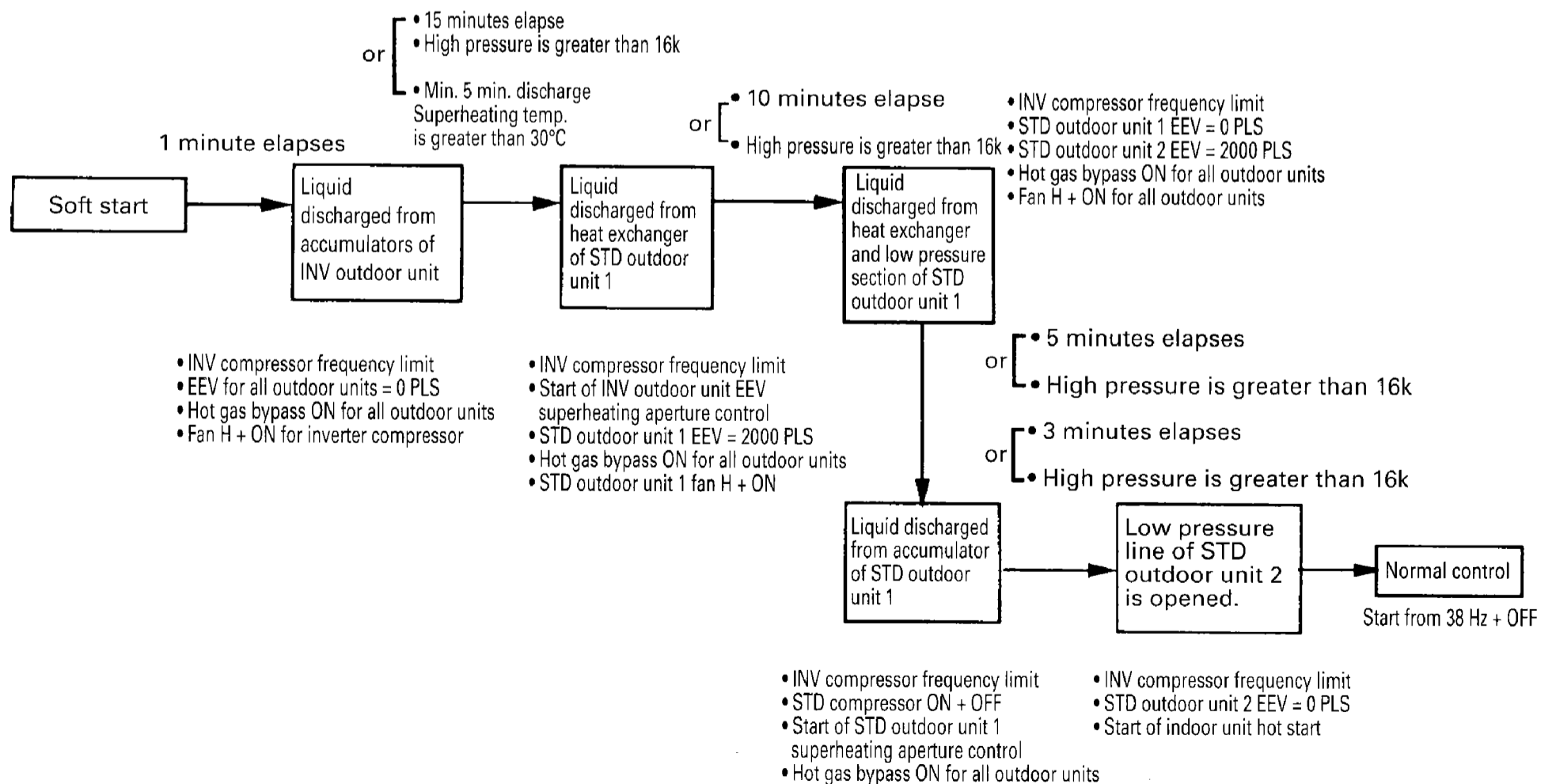

Compressor frequency change during control

Same as heating pump down control

## Heating start following layup

(Except for cooling only system)

Discharge refrigerant from outdoor unit or pressure equalizing piping when starting if the compressor has been stopped for 3 hours or more or when starting for the first time after turning on the power. Also discharges refrigerant when starting for the first time if the 6 or more hours has elapsed since turning on the power.

After completing soft start, compressor operating frequency is held to (60 Hz + OFF) ~ (96 Hz + OFF), refrigerant in the pressure equalizing line and low pressure line is discharged and the unit is prepared for normal compressor control.

### Conditions for layup starting after tuning on the power

- or
- Inverter comp. oil temp. greater than outdoor temp. + 15°C
  - Inverter comp. discharge temp. greater than outdoor temp. + 10°C (Outdoor temp. greater than or equal to 0°C)
  - Inverter type comp. discharge temp. greater than 10°C (Outdoor temp. greater than or equal to 0°C)

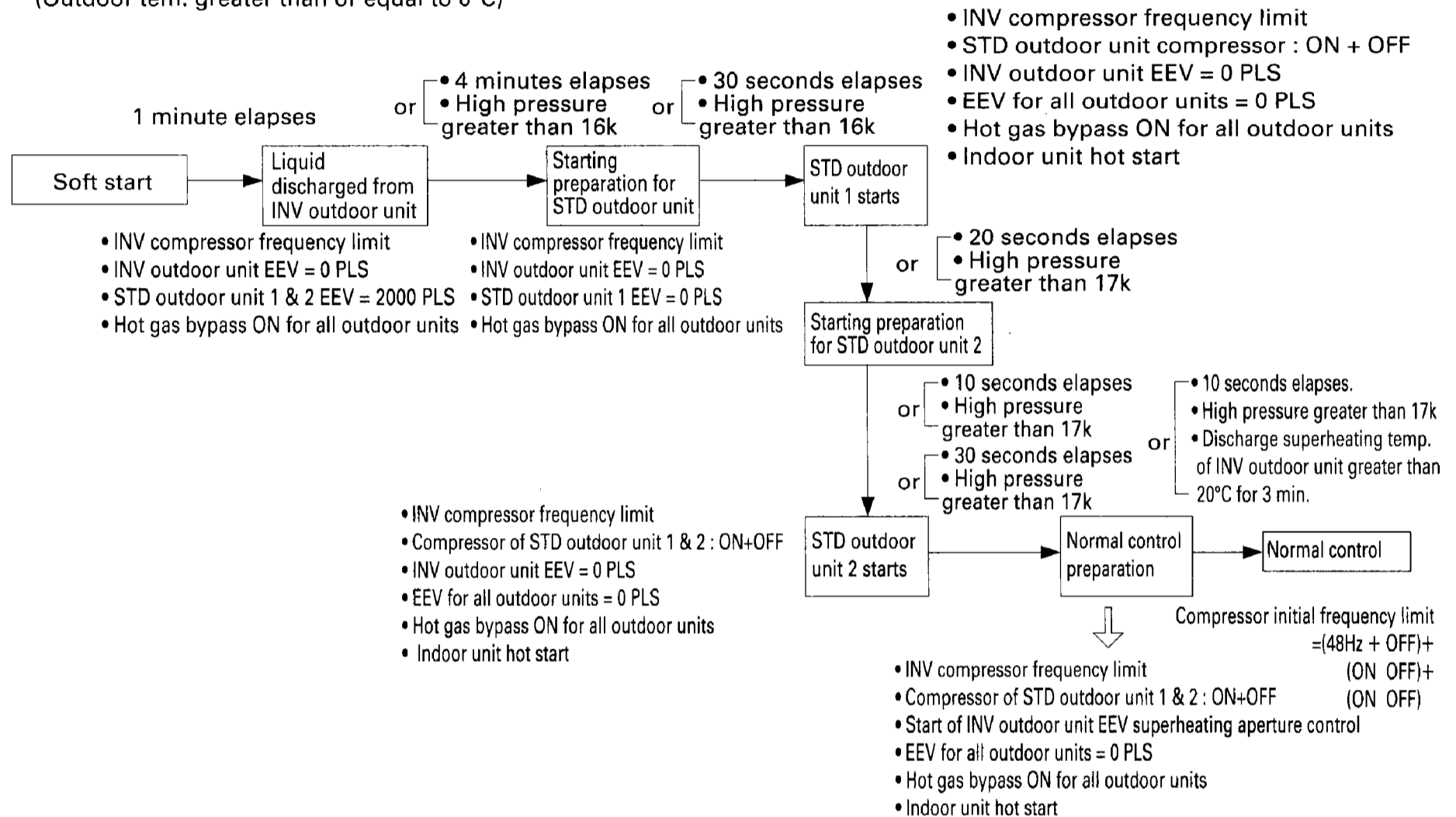

Compressor frequency change during control

Same as heating pump down control

## 2. Pressure Equalizing Control Before Starting

If differential pressure remains when the compressor starts, starting current increases and the unit may stop due to malfunction. In order to prevent this, the hot gas bypass valve is opened for a certain amount of time just before the compressor starts to equalize the pressure between high and low pressure. After this control is completed, the unit immediately enters soft control.

	Control contents	Required time
When cooling	Hot gas bypass valve ON for INV outdoor unit and STD outdoor unit 1	1 minute
When heating		2 minutes. However, requires 3 minutes if $T_c - T_e > T$ when 1 minute elapses.

T is a constant determined by outdoor temperature and  $T_e$ .

<In case of cooling only system>

	Control contents	Required time
When cooling	Function unit's solenoid valve Y5, Y6, Y7 are ON	1 minute

### 3. Oil Return Control

In order to recover refrigeration oil, when total compressor operation capacity equals the reference values, the capacity is increased, all solenoid valves in the system are fully opened and the oil is recovered at each compressor.

#### Conditions for executing oil control

Total compressor operating time = point when approx. 8 hours elapses (Differs somewhat according to operation status.)

Operating contents

When cooling

Step 1: Collected oil is recovered.

	INV outdoor unit	STD outdoor unit 1	STD outdoor unit 2
Compressor	(106Hz + ON)	+ (ON + ON)	+ (ON + ON)
EEV	2000pls	2000pls	2000pls
Outdoor unit fan	H + ON	H + ON	H + ON
Outdoor unit heat exchanger	Condenser	Condenser	Condenser
Solenoid valve for oil discharge		OFF	
Injection	ON + OFF	ON + OFF	ON + OFF
Hot gas		OFF	

Outdoor unit suction pipe temp. greater than or equal to  $T_e + 10$  at when either 6 min. or 4 min. elapses.

Step 2: Refrigerant is discharged from accumulator.

	INV outdoor unit	STD outdoor unit 1	STD outdoor unit 2
Compressor	(60Hz + ON)	+ (ON + OFF)	+ (ON + OFF)
EEV	2000pls	2000pls	2000pls
Outdoor unit fan	H + ON	H + ON	H + ON
Outdoor unit heat exchanger	Condenser	Condenser	Condenser
Solenoid valve for oil discharge		ON	
Injection	ON + OFF	ON + OFF	ON + OFF
Hot gas		ON at $L_p < 1.0$ k	

3 minutes elapses or suction pressure  $< 1.0$

Quit

When heating

Preparation for oil return

Upper limit frequency limited to 38 Hz + ON

1 minute elapses

Step 1: 4-way valve switched (30 sec. after start)

	INV outdoor unit	STD outdoor unit 1	STD outdoor unit 2
Compressor	(38Hz + ON)	+ (ON + OFF)	+ (ON + OFF)
EEV	2000pls	2000pls	2000pls
Outdoor unit fan	H + ON	H + ON	H + ON
Outdoor unit heat exchanger	Condenser	Condenser	Condenser
Solenoid valve for oil discharge		ON	
Injection	ON + OFF	ON + OFF	ON + OFF
Hot gas		ON	

30 seconds elapse

Step 2: Collected oil is recovered.

	INV outdoor unit	STD outdoor unit 1	STD outdoor unit 2
Compressor	(106Hz + ON)	+ (ON + ON)	+ (ON + ON)
EEV	2000pls	2000pls	2000pls
Outdoor unit fan	H + ON	H + ON	H + ON
Outdoor unit heat exchanger	Condenser	Condenser	Condenser
Solenoid valve for oil discharge		ON	
Injection	ON + OFF	ON + OFF	ON + OFF
Hot gas		OFF	

Outdoor unit suction pipe temp. greater than or equal to  $T_e + 10$  at when either 6 min. or 4 min. elapses.

Step 3: Refrigerant is discharged from accumulator. (3 minutes)

	INV outdoor unit	STD outdoor unit 1	STD outdoor unit 2
Compressor	(60Hz + OFF)	+ (ON + OFF)	+ (ON + OFF)
EEV		SH control	
Outdoor unit fan	H + ON	H + ON	H + ON
Outdoor unit heat exchanger	Evaporator	Evaporator	Evaporator
Solenoid valve for oil discharge		OFF	
Injection	ON + OFF	ON + OFF	ON + OFF
Hot gas		ON at $L_p < 2.5$ k	

3 minutes elapses or HP  $> 21$  k

Quit

Liquid refrigerant collected in indoor unit returned to receiver

<In case of cooling only system>

Operating contents

When cooling

Step 1: Collected oil is recovered.

	INV outdoor unit	STD outdoor unit 1	STD outdoor unit 2
Compressor	(106Hz + ON)	+ (ON + ON)	+ (ON + ON)
Outdoor unit fan	H + ON	H + ON	H + ON
Outdoor unit heat exchanger	Condenser	Condenser	Condenser
Solenoid valve for oil discharge		OFF	
Injection	ON + OFF	ON + OFF	ON + OFF

Outdoor unit suction pipe temp. greater than or equal to  $T_e + 10$  at when either 6 min. or 4 min. elapses.

Step 2: Refrigerant is discharged from accumulator.

	INV outdoor unit	STD outdoor unit 1	STD outdoor unit 2
Compressor	(60Hz + ON)	+ (ON + OFF)	+ (ON + OFF)
Outdoor unit fan	H + ON	H + ON	H + ON
Outdoor unit heat exchanger	Condenser	Condenser	Condenser
Solenoid valve for oil discharge		ON	
Injection	ON + OFF	ON + OFF	ON + OFF
Function unit's solenoid valve	Y5-ON at $L_p < 1.0$	Y6-ON at $L_p < 1.0$ k	Y7-ON at $L_p < 1.0$ k

3 minutes elapses or suction pressure  $< 1.0$

Quit

## 4. Defrost (Except for Cooling only system)

Melts frost which might collect on outdoor heat exchangers during heating in order to recover their heat conveying performance.

### Conditions for executing defrost

- At least 20 minutes have elapsed since completion of oil return or since compressor starts.
- High pressure less than 19.9k (Tc = 52.4°C)
- Compressor is running at least 30 minutes since completion of previous defrost.
- Liquid pipe thermal detection temperature is less than or equal to T°C for 5 minutes during operation for all units, or 15 minutes for any one outdoor unit.

$$T = C \times (\text{Outdoor temp.}) - \alpha$$

(C is constant)

- Forced defrost test pin (MDS) is shorted.
- Liquid pipe thermal detection temperature is less than or equal to 12.5°C for 5 minutes for all units
- High pressure less than 19.9k (Tc = 52.4°C)

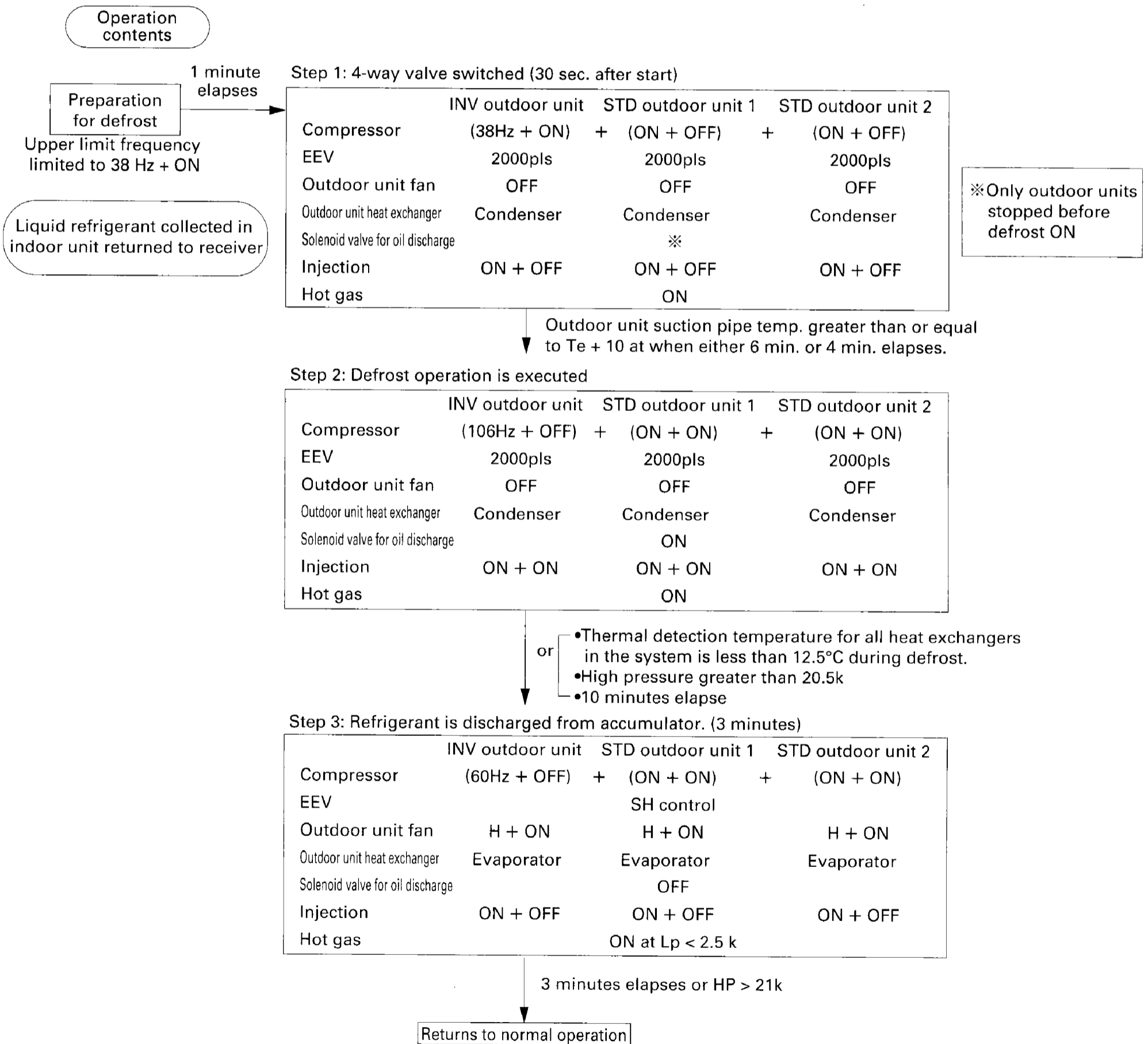

## 5. Oil Equalization Control

Because oil could collect in the outdoor units or between inverter outdoor unit and standard outdoor unit 1 outdoor units when only inverter outdoor unit is operating due to the compressor stopping during operation, oil that collects in standard outdoor unit 1 is returned to inverter outdoor unit.

### When cooling

Oil is moved between inverter outdoor unit and standard outdoor unit 1 units by operating them simultaneously. When all three systems are operating, however, oil equalization is not executed because oil separation is not carried out.

#### Operation conditions

- 2-system operation
- At least 20 minutes has elapsed since completing start processing, and at least 20 minutes has elapsed since oil return.
- At least 28 minutes has elapsed since defrost.
- At least 10 continuous minutes has elapsed since standard outdoor unit 1 compressor started running after completion of defrost.
- At least 3 minutes has elapsed since standard outdoor unit 1 compressor started or since oil return.
- At least A time has elapsed by total operating time of standard outdoor unit 1 compressor since completion of previous oil equalization operation.

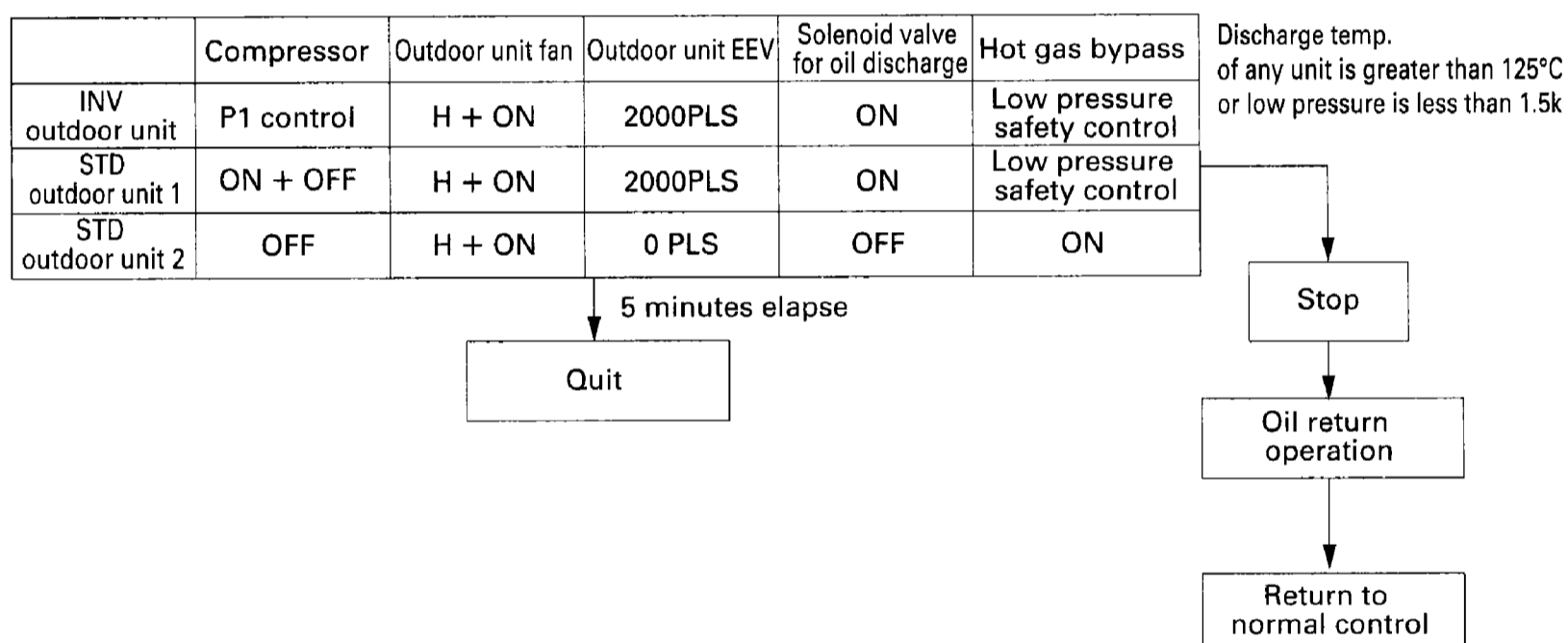

#### A Time

	16Hp	18Hp	20Hp	24Hp	26Hp	28Hp	30Hp
Cooling	2 hours	2 hours	2 hours	2 hours	2 hours	2 hours	2 hours
Heating	3 hours	3 hours	2 hours	3 hours	3 hours	3 hours	2 hours



<In case of cooling only system>

Oil is moved between inverter outdoor unit and standard outdoor unit 1 units by operating them simultaneously.  
When all three systems are operating, however, oil equalization is not executed because oil separation is not carried out.

Operation conditions

- 2-system operation
- At least 20 minutes has elapsed since completing start processing, and at least 20 minutes has elapsed since oil return.
- & • At least 28 minutes has elapsed since defrost.
- or
  - At least 10 continuous minutes has elapsed since standard outdoor unit 1 compressor started running after completion of defrost.
  - &
    - $T_{01-1} > T_e + 10^{\circ}\text{C}$
    - At least 3 minutes has elapsed since standard outdoor unit 1 compressor started or since oil return.
- At least A time has elapsed by total operating time of standard outdoor unit 1 compressor since completion of previous oil equalization operation.

	Compressor	Outdoor unit fan	Solenoid valve for oil discharge	Function unit's solenoid valve
INV outdoor unit	P1 control	H + ON	ON	Low pressure safety control
STD outdoor unit 1	ON + OFF	H + ON	ON	Low pressure safety control
STD outdoor unit 2	OFF	H + ON	OFF	Y7-ON

Discharge temp. of any unit is greater than 125°C or low pressure is less than 1.5k

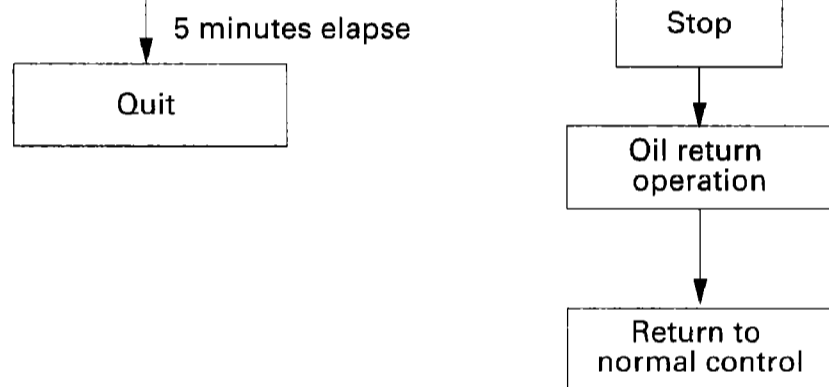

A Time

	16Hp	18Hp	20Hp	24Hp	26Hp	28Hp	30Hp
Cooling	2 hours	2 hours	2 hours	2 hours	2 hours	2 hours	2 hours

## When heating

Oil level between both units is equalized in 2 steps: oil transfer from INV outdoor unit to STD outdoor unit 1, and STD outdoor unit 1 to INV outdoor unit.

When all three systems are operating, however, oil equalization is not executed because oil separation is not carried out.

### Operation conditions

- 2-system operation
  - At least 20 minutes has elapsed since completing start processing, and at least 20 minutes has elapsed since oil return.
  - At least 28 minutes has elapsed since defrost.
- &
- or
    - At least 10 continuous minutes has elapsed since the INV outdoor unit compressor started running in normal heating operation (doesn't include oil return and defrost).
    - &
      - $T_{01-1} > T_e + 10^\circ\text{C}$
      - At least 3 continuous minutes has elapsed since INV outdoor unit compressor started running in normal heating operation (doesn't include oil return and defrost).
  - or
    - At least A time has elapsed by total operating time of STD outdoor unit 1 compressor since completion of previous oil equalization operation.
    - The standard type 1 compressor has stopped and defrost has been executed B times since completion of previous oil equalization operation.

**Step 1** : Oil collected in inverter type is returned to STD outdoor unit 1.

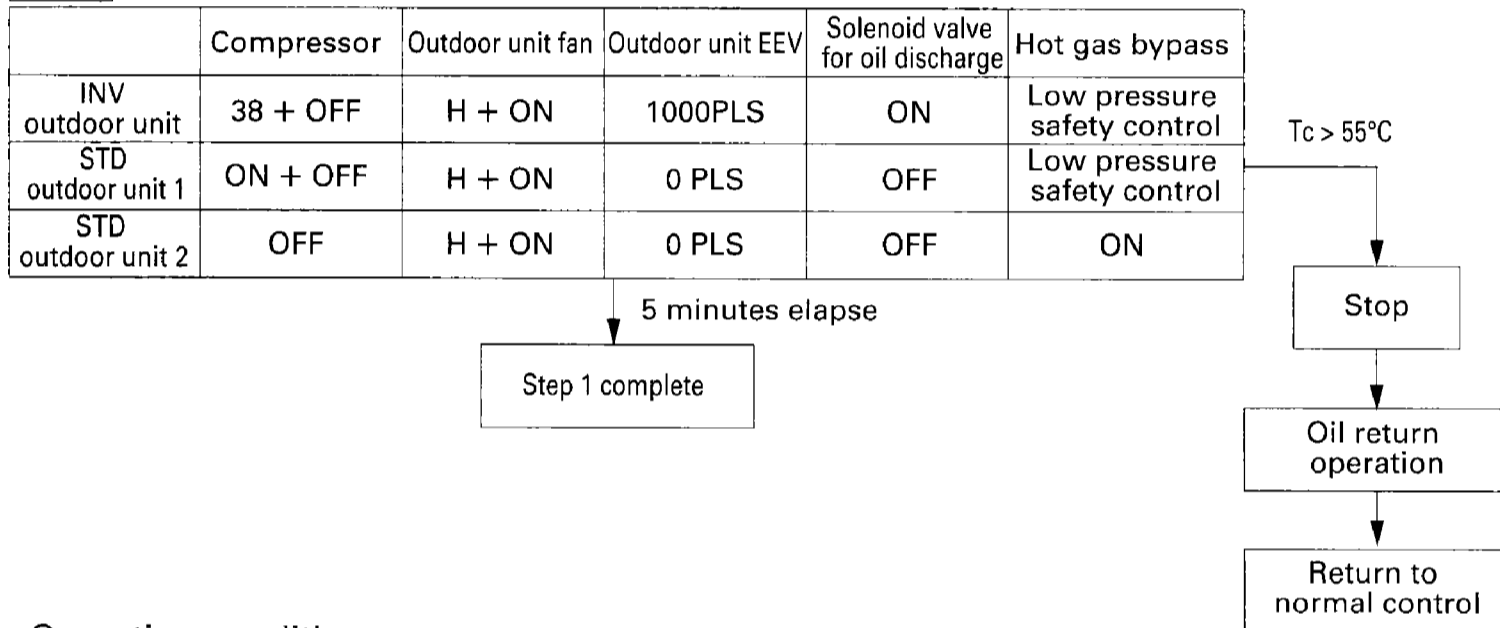

### Operation conditions

- 2-system operation
  - At least 20 minutes has elapsed since completing start processing, and at least 20 minutes has elapsed since oil return.
  - At least 28 minutes has elapsed since defrost.
- &
- or
    - At least 10 continuous minutes has elapsed since the STD outdoor unit 1 compressor started running in normal heating operation (doesn't include oil return and defrost).
    - &
      - $T_{01-2} > T_e + 10^\circ\text{C}$
      - At least 3 continuous minutes has elapsed since STD outdoor unit 1 compressor started running in normal heating operation (doesn't include oil return and defrost).
- Step 1 complete

**Step 2** : Oil collected in STD outdoor unit 1 is returned to INV outdoor unit.

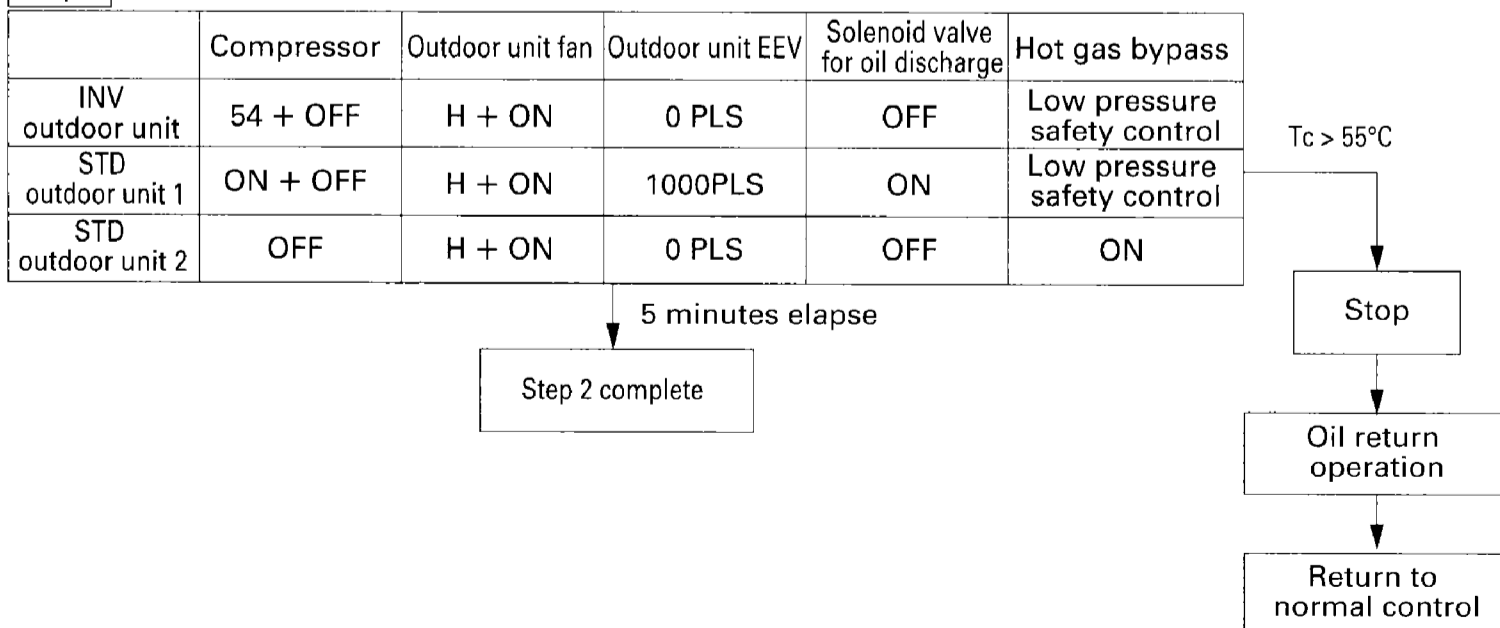

### B Times

	16Hp	18Hp	20Hp	24Hp	26Hp	28Hp	30Hp
Heating	5 times						

## 6. Heating Pump Down Residual Operation (Except for Cooling only system)

If refrigerant collects in the accumulator, the liquid refrigerant is sucked into the compressor when it starts. This dilutes the refrigeration oil in the compressor and lowers the oil's ability to provide lubrication. Low pressure side refrigerant is therefore discharged when the compressor is stopped in order to prevent this from happening.

### Conditions for pump down residual operation

- &
- INV compressor discharge temp. less than 95°C when off
  - Any one of these
    - Stopped no more than 10 minutes from compressor start
    - No more than 20 minutes from completion of defrost or oil return
    - Outdoor temp. less than -5°C
    - INV compressor oil temp. less than  $T_e + 10^\circ\text{C}$

### Operation contents

Outdoor temp.	Outdoor unit function		L unit function	Indoor unit function
	Compressor	EEV	Receiver gas purge solenoid valve	EEV
Less than -10°C	86Hz + OFF	300 PLS	ON	300 PLS
-10°C ≤ Temp. < 0°C	76Hz + OFF	or fully		
Min. 0°C	60Hz + OFF	closed		

Outdoor unit EEV are either 300m PLS or fully closed due to low pressure.

### Completion conditions

- Any one of these
- Low pressure less than 0.7k after 30 sec. subsequent to start of residual operation
  - INV compressor oil temp. greater than 110°C
  - Retry, malfunction
  - 10 minutes have elapsed since start of residual operation

This control is executed if stopped during defrost or oil return. Pump down is started if a start command is received during residual operation.

## 7. Compressor Oil Temperature Protection Control

- ① Even if the compressor is running, if oil temperature of the inverter compressor lowers, the control crankcase heater (CH3) is energized and refrigerant is discharged from inside the compressor by evaporation.

### Control conditions

Crankcase heater (CH3) is turned on if inverter compressor oil temp. drops lower than 0°C.

### Control cancel conditions

Crankcase heater (CH3) is turned off if inverter compressor oil temp. rises above 40°C.

- ② Compressor operating capacity is controlled if oil temperature of outdoor units drops below the reference value.

	Control conditions	Cancel conditions	Contents
INV outdoor unit	No more than 30 min. after start or no more than 20 min. since completion of defrost or oil return & INV compressor temp. lower than -15°C	Time given on left has been exceeded or INV compressor temp. above -10°C	Limited to either: 106+OFF (106+OFF) + (ON+OFF) (106+OFF) + (ON+OFF) + (ON+OFF)
STD outdoor unit 1	No more than 30 min. after start or no more than 20 min. since completion of defrost or oil return & No.1 compressor temp. lower than -15°C	Time given on left has been exceeded or No.1 compressor temp. above -10°C	Limited to either: (106+ON) + (ON+OFF) (106+ON) + (ON+OFF) + (ON+OFF)
STD outdoor unit 2	No more than 30 min. after start or no more than 20 min. since completion of defrost or oil return & No.1 compressor temp. lower than -15°C	Time given on left has been exceeded or No.1 compressor temp. above -10°C	Limited to (106+ON) + (ON+ON) + (ON+OFF)

## 8. Low Pressure Protection Control Step

The following types of control are executed if low pressure drops below the reference values in order to prevent temperature inside the compressor from rising abnormally due to drop of compressor suction pressure, and in order to maintain oil pressure for supplying oil to the inside of the compressors during operation.

### ① Low Pressure Protection Control

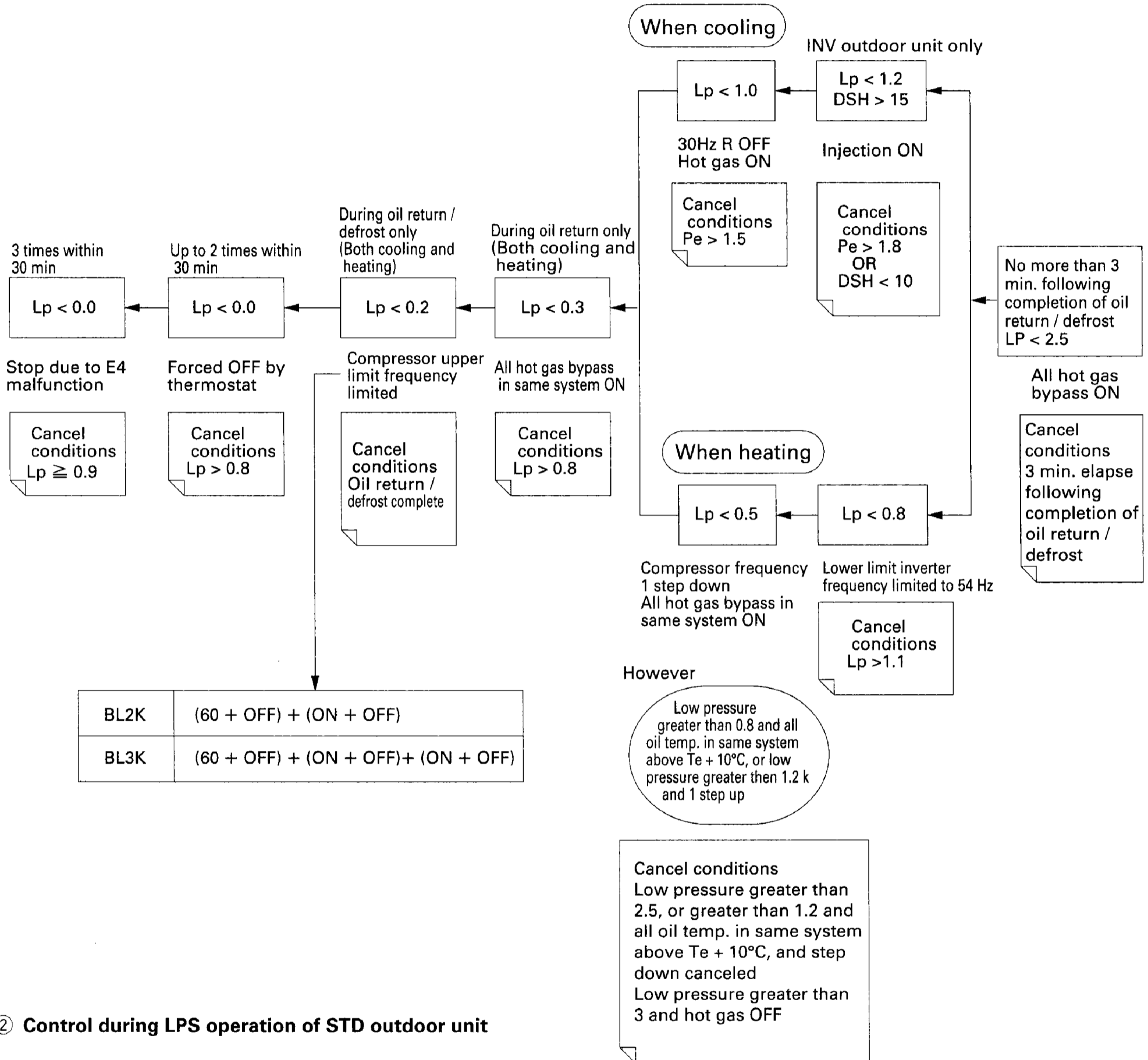

### ② Control during LPS operation of STD outdoor unit

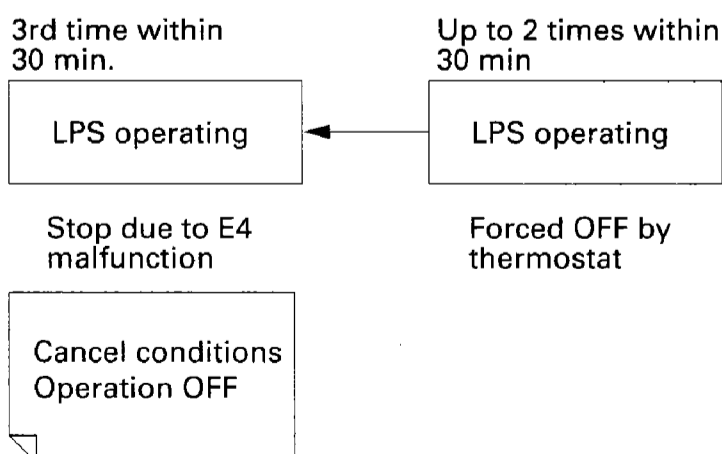

<In case of cooling only system>

① **Low Pressure Protection Control**

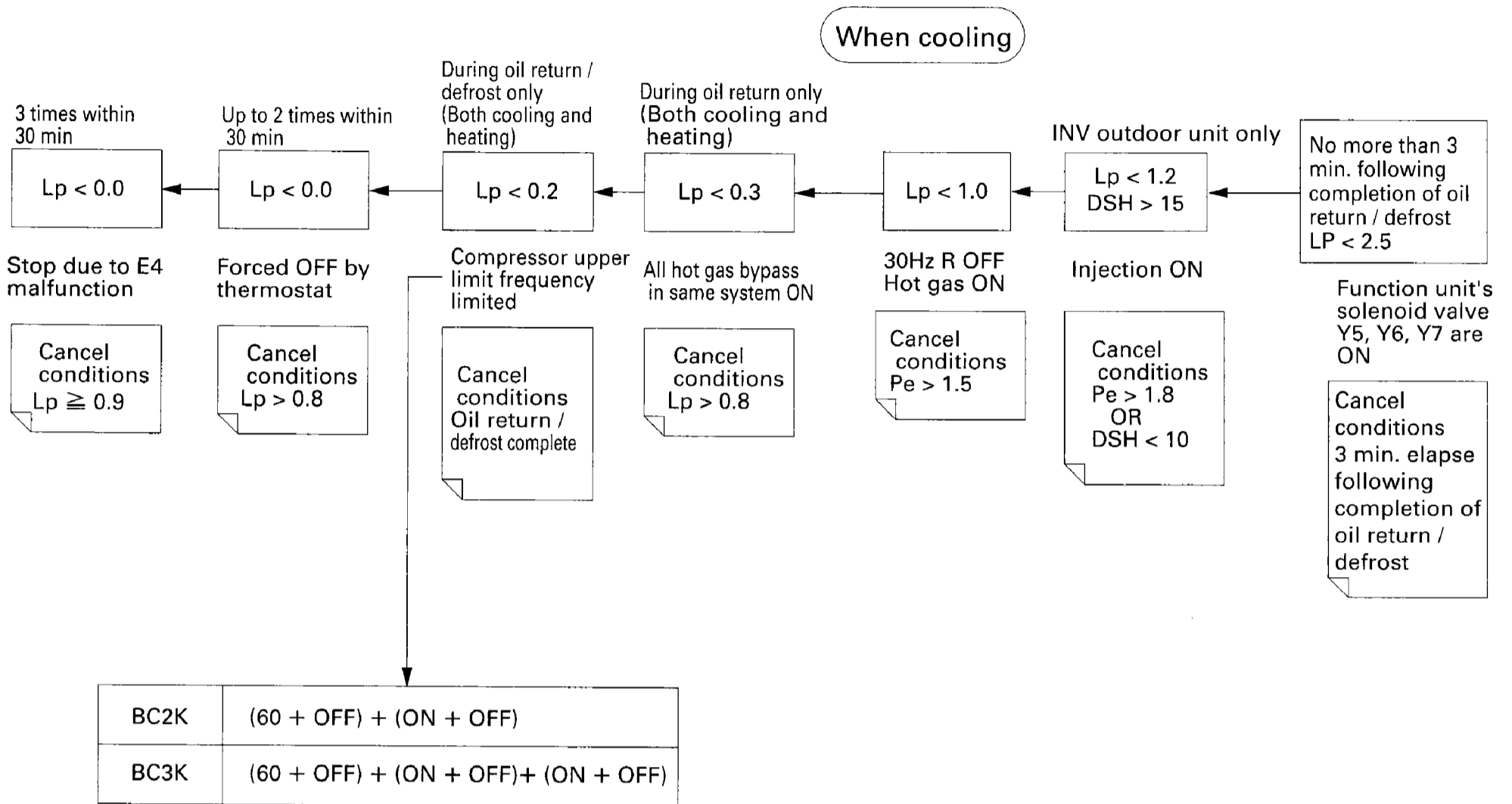

② **Control during LPS operation of STD outdoor unit**

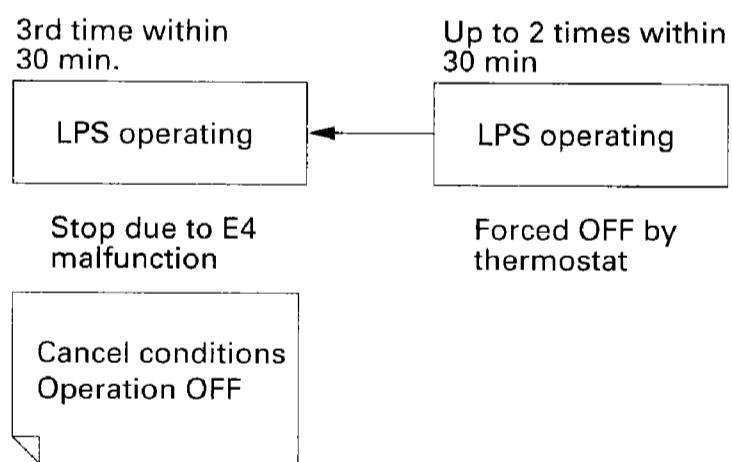

## 9. High Pressure Control Step

In order to check high pressure rise, the compressor's operation capacity is reduced if high pressure rises above the reference value. When heating, outdoor unit fans are set to (L + OFF), and indoor unit solenoid valves are fully opened.

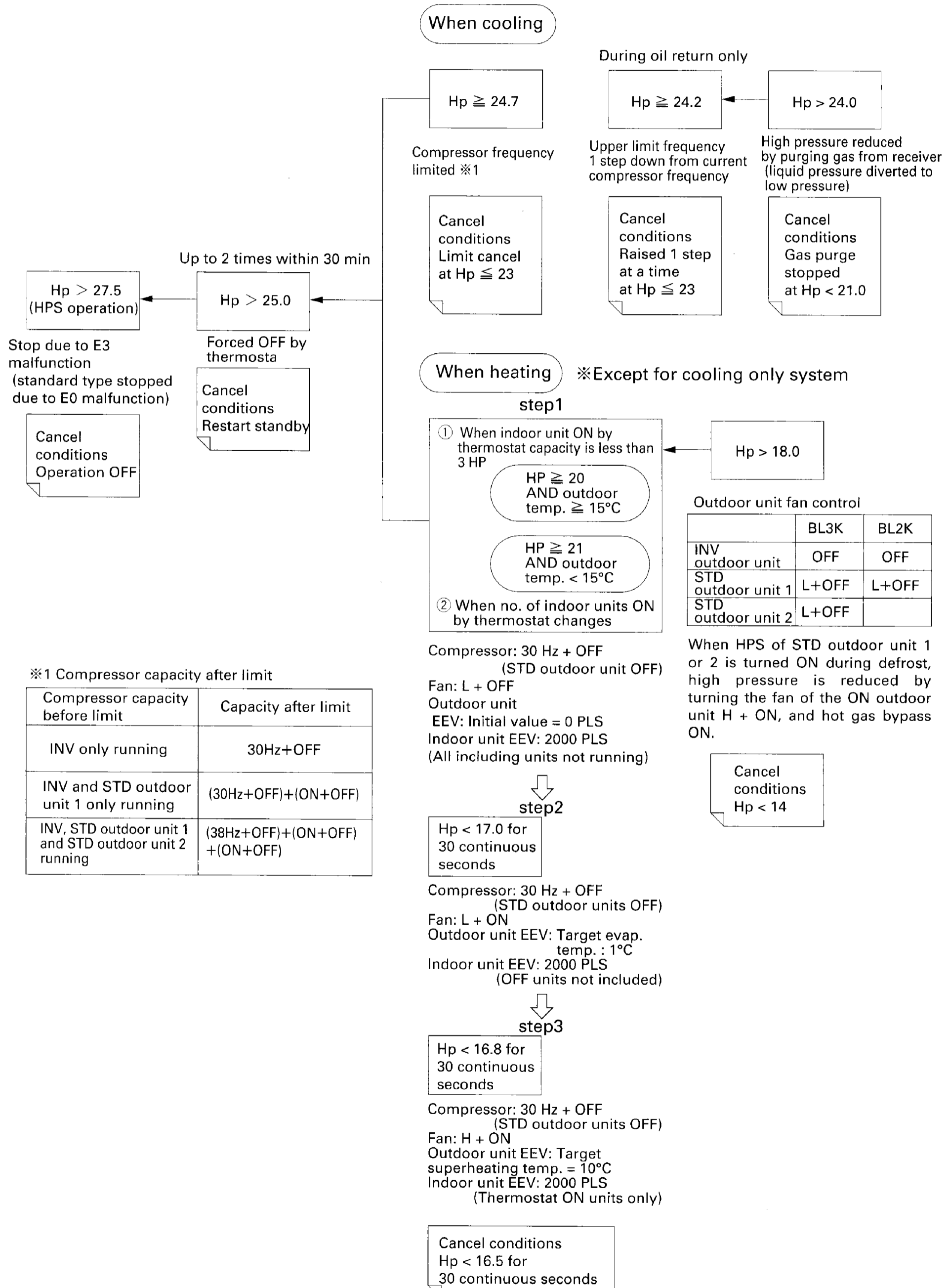

## 10. Discharge Temperature Protection Control

In order to prevent deterioration of refrigeration oil due to rising discharge temperature, temperature is kept from rising by reduction of compressor frequency or injection cooling at the following stages when temperature falls below the reference values.

### Both inverter and standard outdoor units

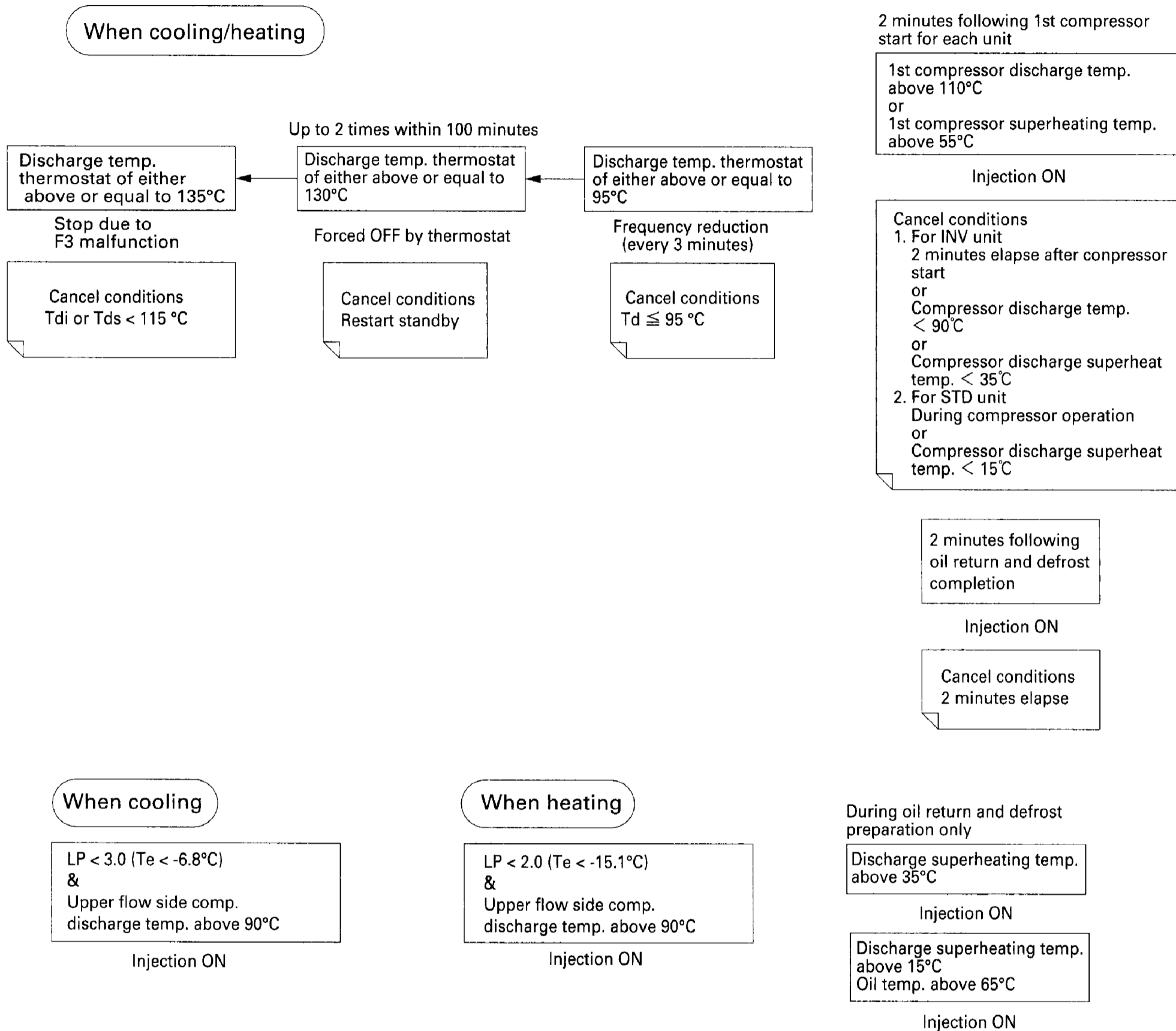

**Injection cancel conditions**  
Injection is canceled if any of the following five conditions are met.

1st compressor discharge temp. below 90°C & 1st compressor discharge superheating temp. below 50°C Oil temp. below 55°C	Upper flow side comp. discharge superheating temp. below 15°C
Upper flow side comp. discharge temp. below 105°C & Upper flow side comp. discharge superheating temp. below 50°C Oil temp. below Te + 10°C	LP > 4.0 (Te > -0.4°C) or Upper flow side comp. discharge temp. below 70°C
	LP > 4.0 (Te > -10.7°C) or Upper flow side comp. discharge temp. below 80°C



## 11. Cooling Overload Control

Controls electronic expansion valve aperture of indoor units to prevent low pressure from rising abnormally if many indoor units are operating.

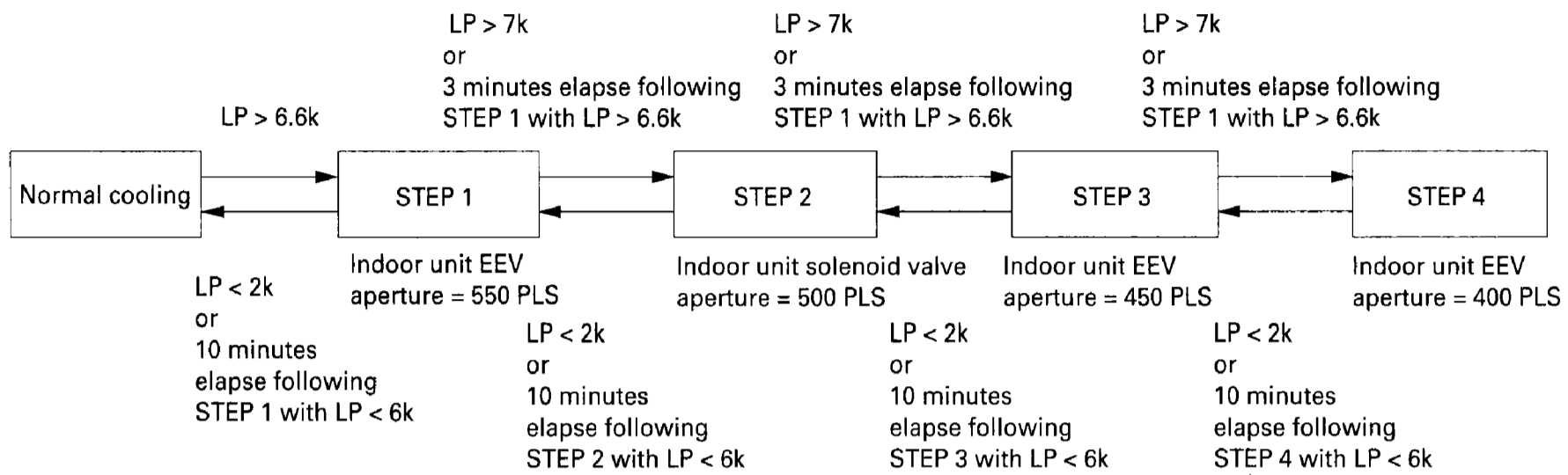

## 12. Inverter Protection Control

### ① Step down control by inverter current

Reduces compressor operating capacity if current is detected to be in excess of the setting value in order to protect the inverter from overcurrent.

IN conditions	Control contents
27A or more detected	Capacity lowered one step from compressor capacity at this point is used as upper limit. After that, one step is advanced every three minutes if current doesn't exceed the setting value.

OUT conditions Upper limit frequency is limited/canceled if:  
 $106 + ON$  when INV outdoor unit only is operating.  
 $(106 + ON) + (ON + ON)$  if 2 systems operating  
 $(106 + ON) + (ON + ON) + (ON + ON)$  if 3 systems operating

### ② Step down control by inverter fin

Reduces compressor operating capacity if current exceeds the setting value in order to prevent the temperature of the inverter itself from rising above the setting value.

IN conditions	Control contents
Fin temp. $92^{\circ}C$ or higher detected	Capacity lowered one step from compressor capacity at this point is used as upper limit. After that, one step is advanced every three minutes if current doesn't exceed $87^{\circ}C$ .

## 13. Standby by Outdoor Temperature When Heating (Except for Cooling only system)

If outdoor temperature is above  $27^{\circ}C$  when heating, forces the compressor to stop to prevent safety devices from tripping or sensor malfunction. (Same as off by thermostat.)

## 14. Low Outdoor Temperature Control When Cooling

Controls the fan in order to prevent high-low pressure differential from dropping due to high pressure reduction if cooling when outdoor temperature is low.

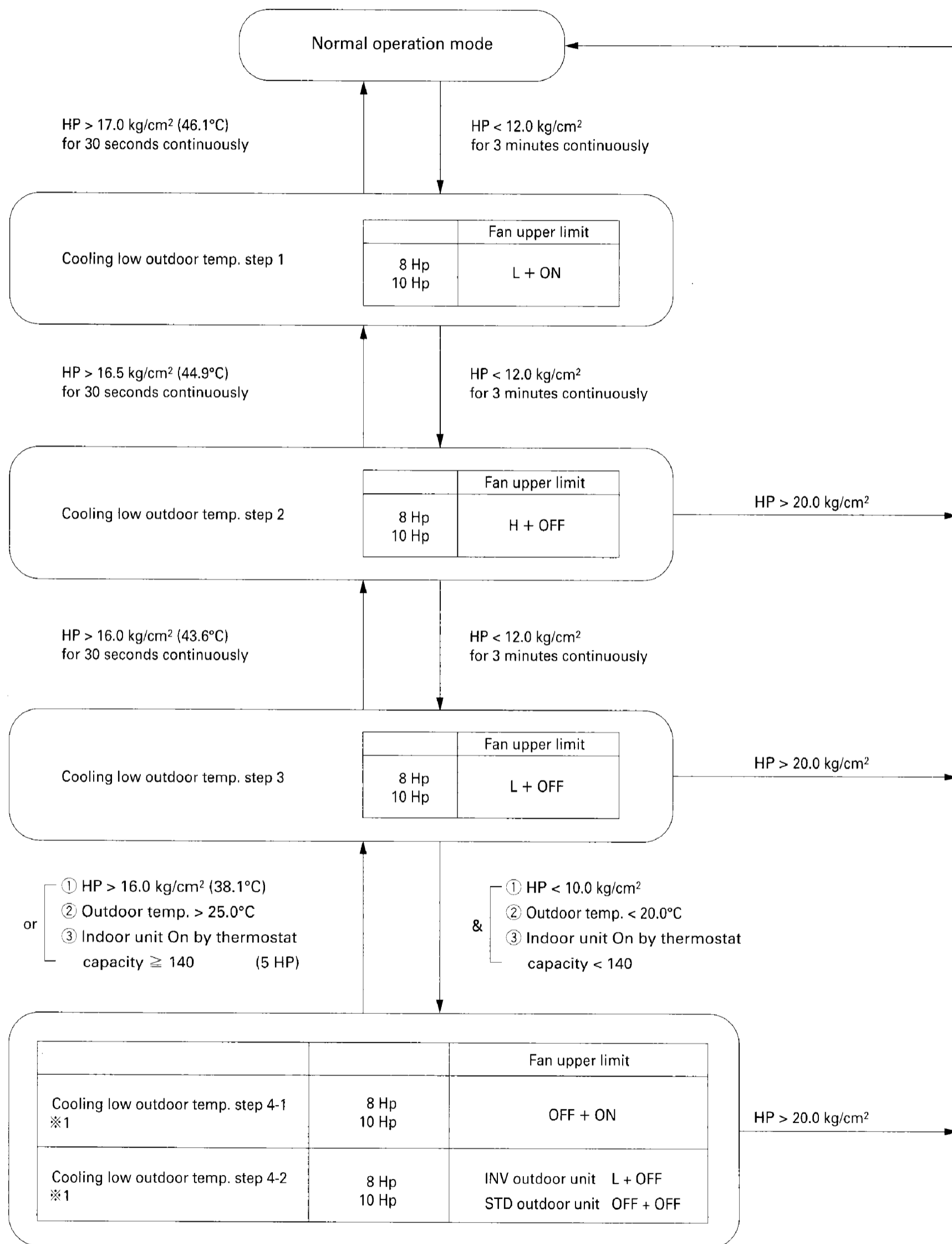

※1: Inverter cooling is insufficient to stop the fan at 4-1. When inverter fin temperature reaches 80°C or higher, the inverter is cooled by the inverter fan at step 4-2.

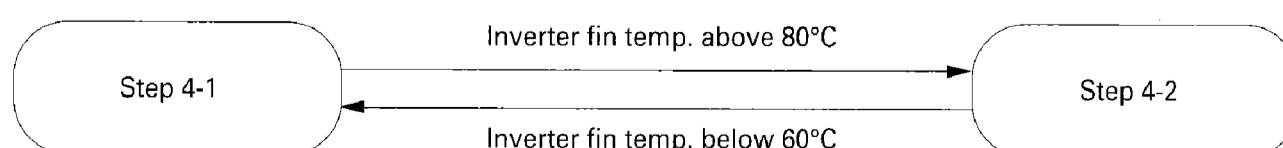

## 15. Low Noise Control

- During cooling operation when the outdoor air temperature is low, outdoor unit fans, electronic expansion valve and compressors are controlled as follows in order to primarily maintain high pressure and to check drop in refrigerant circulation caused by drop in high pressure.

### Action during low noise operation (Except oil return, defrost)

Conditions	Outdoor Fan	Limit of compressor frequency	
		INV outdoor unit	STD outdoor unit
①	H + OFF	96Hz + OFF	ON + OFF
②	L + ON		

- ① Discharge pressure  $\leq 24\text{kg/cm}^2$   
 ② Discharge pressure  $> 24\text{kg/cm}^2$

External control adaptor for outdoor unit is required to the low noise control

## 16. Demand Control

- By connecting the external contact input to the Demand control input of the outdoor unit external control adaptor(option), you can save power with limit of compressor frequency.

### Limit of compressor frequency in demand control

	3 outdoor units	2 outdoor units	Capacity saving
	RX(Y) 24 ~ 30K REY 24 ~ 30K (24 ~ 30Hp)	RX(Y) 16 ~ 20K REY 16 ~ 20K (16 ~ 20Hp)	
Demand input 1	INV (106 + ON) STD1 (ON + OFF) STD2 (ON + OFF)	INV (106 + ON) STD (ON + OFF)	Power consumption will be reduced to around 70% of normal usage.
Demand input 2	INV (60 + ON) STD1 (ON + OFF) STD2 (OFF + OFF)	INV (106 + OFF) STD (OFF + OFF)	Power consumption will be reduced to around 40% of normal usage.
Demand input 3	Forced thermostat OFF		Not run

## 17. Compressor Capacity Control

- 2 outdoor units combination

RX(Y)16K, RX(Y)18K, RX(Y)20K

INV outdoor unit	STD outdoor unit
30Hz + OFF	OFF + OFF
34Hz + OFF	
38Hz + OFF	
42Hz + OFF	
48Hz + OFF	
54Hz + OFF	
60Hz + OFF	
68Hz + OFF	
76Hz + OFF	
86Hz + OFF	
96Hz + OFF	
106Hz + OFF	
38Hz + ON	
48Hz + ON	
60Hz + ON	
76Hz + ON	
86Hz + ON	
96Hz + ON	
106Hz + ON	
38Hz + ON	ON + OFF
48Hz + ON	
60Hz + ON	
76Hz + ON	
86Hz + ON	
96Hz + ON	
106Hz + ON	
38Hz + ON	ON + ON
60Hz + ON	
96Hz + ON	
106Hz + ON	

42Hz + ON

: Frequency during soft start

● 3 outdoor units combination

RX(Y)24K, RX(Y)26K, RX(Y)28K, RX(Y)30K

INV outdoor unit	STD outdoor unit 1	STD outdoor unit 2		
30Hz + OFF	OFF + OFF			
34Hz + OFF				
38Hz + OFF				
42Hz + OFF				
48Hz + OFF				
54Hz + OFF				
60Hz + OFF				
68Hz + OFF				
76Hz + OFF				
86Hz + OFF				
96Hz + OFF				
106Hz + OFF				
38Hz + ON			OFF + OFF	
48Hz + ON				
60Hz + ON				
76Hz + ON				
86Hz + ON				
96Hz + ON				
106Hz + ON				
38Hz + ON	ON + OFF			
48Hz + ON				
60Hz + ON				
76Hz + ON				
86Hz + ON				
96Hz + ON				
106Hz + ON				
38Hz + ON	ON + OFF	ON + OFF		
60Hz + ON				
96Hz + ON				
106Hz + ON				
38Hz + ON	ON + ON	ON + OFF		
60Hz + ON				
96Hz + ON				
106Hz + ON				
38Hz + ON	ON + ON	ON + ON		
60Hz + ON				
96Hz + ON				
106Hz + ON				

NOTE: Combinations other than those given above are possible according to operating status.  
(60Hz + OFF) + (ON + OFF) + (ON + OFF)

## 18. Backup Operation

If a STD outdoor unit is faulty, if you restart with the remote controller after it stops due to malfunction, the system starts operating again without the faulty STD outdoor unit.

Backup operation can be used up to a total of 3 hours of indoor unit operation. When 3 hours elapses, if the malfunction continues, the unit stops again due to malfunction. If it returns to normal, it can continue to operate as is.

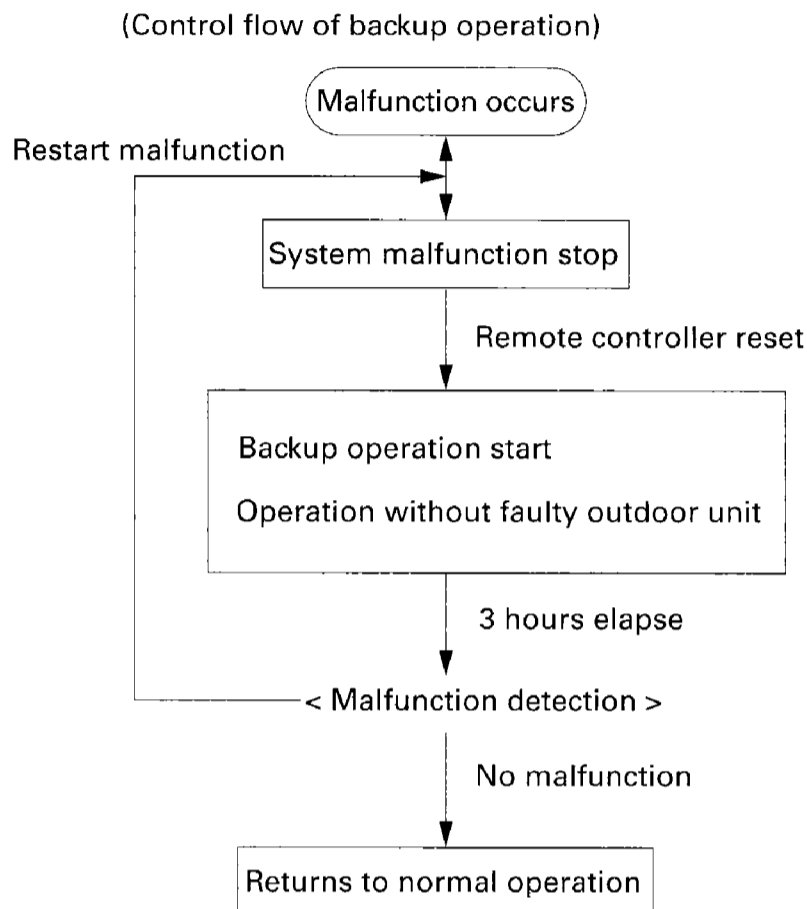

After the system stops due to malfunction to let you know the system is faulty, backup operation is started by remote controller.

Three hours after starting backup operation for the reason given above, malfunction detection is once again carried out, and the system stops due to malfunction if a malfunction still exists.

(All indoor units in the system stop.)

- Operation of faulty STD outdoor unit

	Compressor	Outdoor unit fan	Outdoor unit EEV	Hot gas bypass
Faulty STD outdoor unit	OFF	H + ON	0 PLS	ON

<In case of cooling only system>

	Compressor	Outdoor unit fan	Function unit's solenoid valve Y5, Y6, Y7
Faulty STD outdoor unit	OFF	H + ON	ON

- Other outdoor units carry out normal operation.

## 19. Emergency Operation

### ① Emergency operation 1

If INV outdoor unit cannot operate, you can operate with STD outdoor units only if the outdoor temperature doesn't exceed the reference temperature. Emergency operation is executed by setting mode 2 to EMG (emergency operation).

When cooling

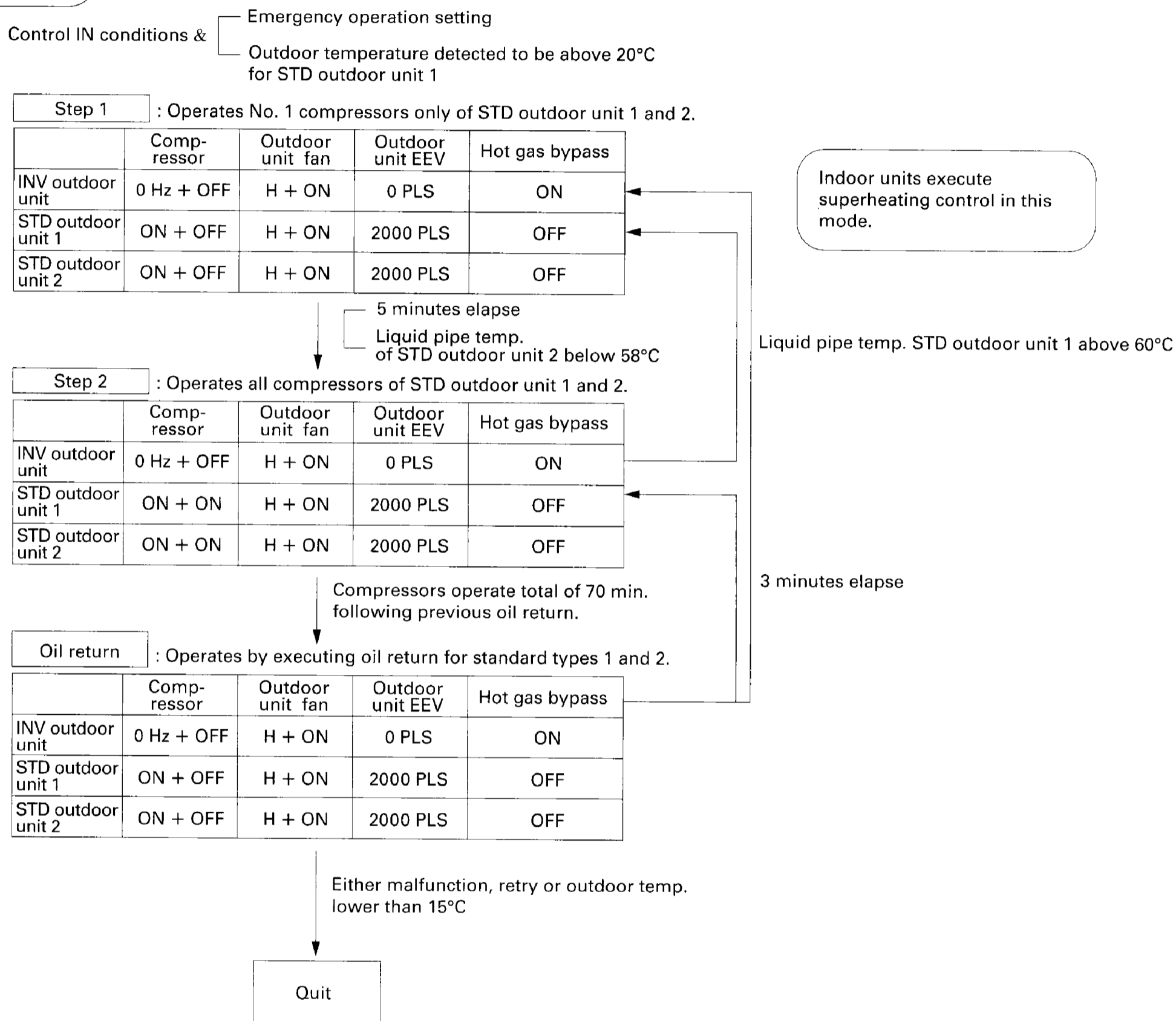

<In case of cooling only system>

Control IN conditions &   
 Emergency operation setting   
 Outdoor temperature detected to be above 20°C   
 for STD outdoor unit 1

**Step 1** : Operates No. 1 compressors only of STD outdoor unit 1 and 2.

	Compressor	Outdoor unit fan	Function unit's solenoid valve
INV outdoor unit	0 Hz + OFF	H + ON	Y5-ON
STD outdoor unit 1	ON + OFF	H + ON	Y6-OFF
STD outdoor unit 2	ON + OFF	H + ON	Y7-OFF

5 minutes elapse   
 Liquid pipe temp.   
 of STD outdoor unit 2 below 58°C

**Step 2** : Operates all compressors of STD outdoor unit 1 and 2.

	Compressor	Outdoor unit fan	Function unit's solenoid valve
INV outdoor unit	0 Hz + OFF	H + ON	Y5-ON
STD outdoor unit 1	ON + ON	H + ON	Y6-OFF
STD outdoor unit 2	ON + ON	H + ON	Y7-OFF

Compressors operate total of 70 min.   
 following previous oil return.

**Oil return** : Operates by executing oil return for standard types 1 and 2.

	Compressor	Outdoor unit fan	Function unit's solenoid valve
INV outdoor unit	0 Hz + OFF	H + ON	Y5-ON
STD outdoor unit 1	ON + OFF	H + ON	Y6-OFF
STD outdoor unit 2	ON + OFF	H + ON	Y7-OFF

Either malfunction, retry or outdoor temp.   
 lower than 15°C

Quit

Indoor units execute   
 superheating control in this   
 mode.

Liquid pipe temp. STD outdoor unit 1 above 60°C

3 minutes elapse

Indoor unit fan control

HPS operation for either STD outdoor unit 1 or 2 fixed to L tap ON by thermostat unit only.



## When heating

Control IN conditions & Emergency operation setting  
Outdoor temperature detected to be above -5°C  
for STD outdoor unit 1

Aperture of solenoid valves is fixed for indoor units in this mode.

**Step 1** : Operates No. 1 compressors only of STD outdoor unit 1 and 2.

	Compressor	Outdoor unit fan	Outdoor unit EEV	Hot gas bypass
INV outdoor unit	0 Hz + OFF	H + ON	0 PLS	ON
STD outdoor unit 1	ON + OFF	H + ON	SH control	OFF
STD outdoor unit 2	ON + OFF	H + ON	SH control	OFF

5 minutes elapse

**Step 2** : Operates all compressors of STD outdoor unit 1 and 2.

	Compressor	Outdoor unit fan	Outdoor unit EEV	Hot gas bypass
INV outdoor unit	0 Hz + OFF	H + ON	0 PLS	ON
STD outdoor unit 1	ON + ON	H + ON	SH control	OFF
STD outdoor unit 2	ON + ON	H + ON	SH control	OFF

Any unit executing HPS operation

**Defrost** : Heat exchange temp. of any unit below -10°C.

**Oil return** : Compressors operate total of 70 min. following previous oil return.

3 minutes 30 seconds (Oil return)

**Oil return / defrost** : Operates by executing oil return for STD outdoor unit 1 and 2.

step 1

	Compressor	Outdoor unit fan	Outdoor unit EEV	Hot gas bypass
INV outdoor unit	0 Hz + OFF	H + ON	0 PLS	OFF
STD outdoor unit 1	ON + OFF	H + ON	2000 PLS	ON
STD outdoor unit 2	ON + OFF	H + ON	2000 PLS	ON

30 seconds elapse

step 2

	Compressor	Outdoor unit fan	Outdoor unit EEV	Hot gas bypass	Injection
INV outdoor unit	0 Hz + OFF	H + ON	0 PLS	OFF	OFF
STD outdoor unit 1	ON + ON	H + ON	2000 PLS	ON	ON
STD outdoor unit 2	ON + ON	H + ON	2000 PLS	ON	ON

10 minutes elapse (defrost or heat exchange temp (both STD outdoor unit 1 and 2) above 12.5°C)

Either malfunction, retry or outdoor temp. lower than 10°C

Quit

## Indoor unit fan control

HPS operation for either STD outdoor unit 1 or 2 fixed to L tap by thermostat ON unit only.

## ② Emergency Operation 2

Setting forced backup operation by setting mode 2 enables emergency operation with INV outdoor unit and other STD outdoor unit if STD outdoor unit malfunction.

- Operation of faulty STD outdoor unit

	Compressor	Outdoor unit fan	Outdoor unit EEV	Hot gas bypass
Faulty STD outdoor unit	OFF	H + ON	0 PLS	ON

<In case of cooling only system>

	Compressor	Outdoor unit fan	Function unit's solenoid valve Y5, Y6, Y7
Faulty STD outdoor unit	OFF	H + ON	ON

- Other outdoor units operate by normal operation.

### (Difference with backup operation)

Backup operation is conducted for a maximum of 3 hours, but there is no time limit with this mode.

## 20. Pump Down Operation

When an outdoor unit is faulty, by fully closing both liquid and pressure equalizing valves and switching to the service mode, you can conduct pump down operation (max. 1 hour) which purges refrigerant from the faulty unit. When doing so, all indoor units are turned ON by thermostat. Refrigerant is discharged from the low pressure line of the faulty unit by cooling with outdoor units that are not faulty up to low pressure equivalent. Pump down operation is quit automatically after one hour. Just before quitting (when approx. 50 minutes elapse), shut the gas pipe's stop valve and then stop the outdoor unit. After another 10 minutes passes, if the pressure in the outdoor unit doesn't exceed outdoor temperature equivalent pressure, the process is complete.

### Pump down operation of INV outdoor unit

First fully close the liquid side and pressure equalizing side stop valves of the INV outdoor unit. The execute low pressure control by setting indoor unit fan to L or off in accordance with the outdoor temperature and No. 2 system outdoor unit suction pipe temperature.

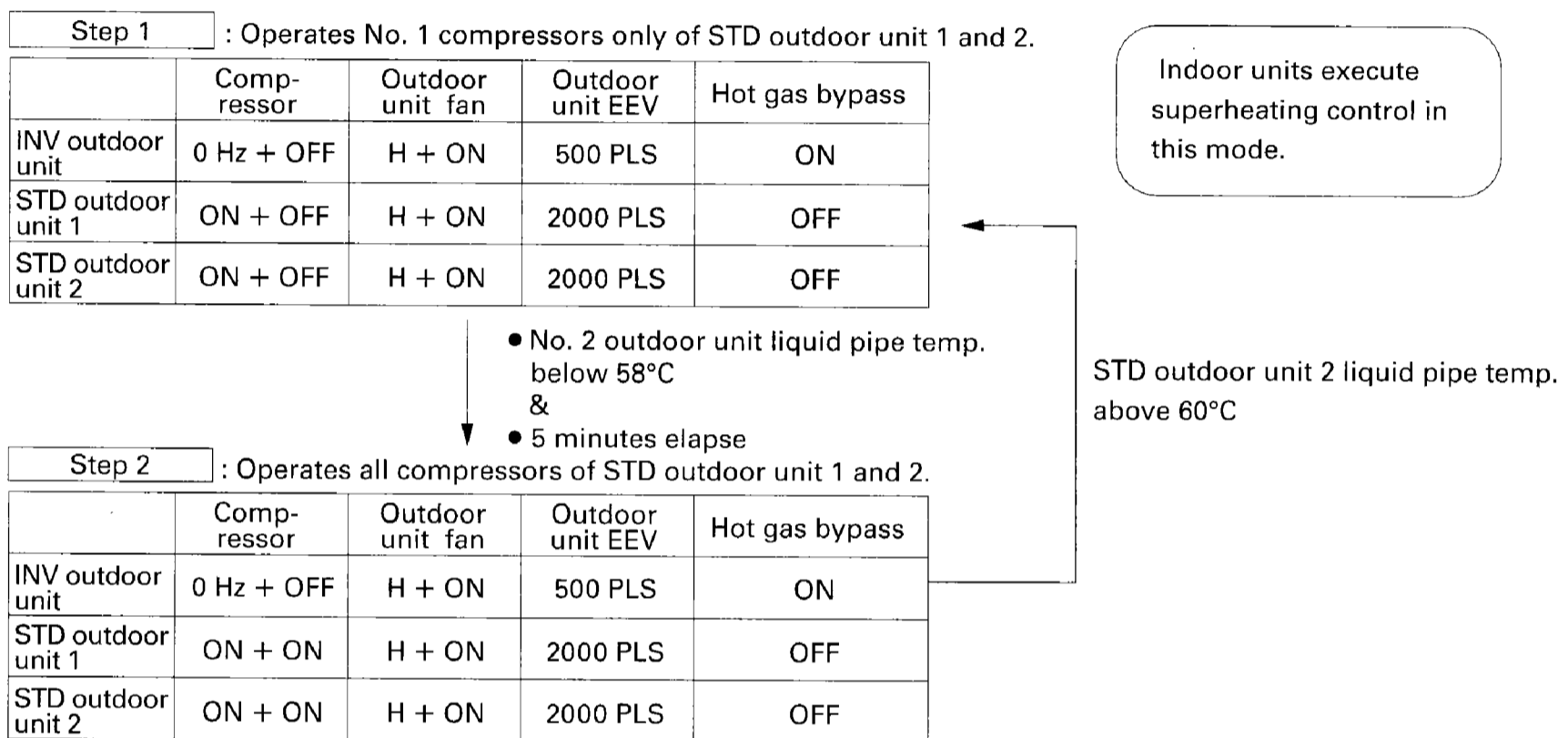

### Pump down operation of STD outdoor unit

First fully close the liquid side and pressure equalizing side stop valves of the STD outdoor unit to be pumped down. The indoor unit fan is fixed at L tap.

- To pump down refrigerant of STD outdoor unit 1

Normal cooling operation is executed by INV outdoor unit and STD outdoor unit 2 only.

	Compressor	Outdoor unit fan	Outdoor unit EEV	Hot gas bypass
INV outdoor unit	P I control	H + ON	2000 PLS	Low pressure protection control
STD outdoor unit 1	OFF	H + ON	500 PLS	ON
STD outdoor unit 2	P I control	H + ON	2000 PLS	Low pressure protection control

Indoor units execute superheating control in this mode.

- To pump down refrigerant of STD outdoor unit 2:

Normal cooling operation is executed by INV outdoor unit and STD outdoor unit 1 only. Outdoor unit operation is same as STD outdoor unit 1.

<In case of cooling only system>

Pump down operation of INV outdoor unit

First fully close the liquid side and pressure equalizing side stop valves of the INV outdoor unit. The execute low pressure control by setting indoor unit fan to L or off in accordance with the outdoor temperature and No. 2 system outdoor unit suction pipe temperature.

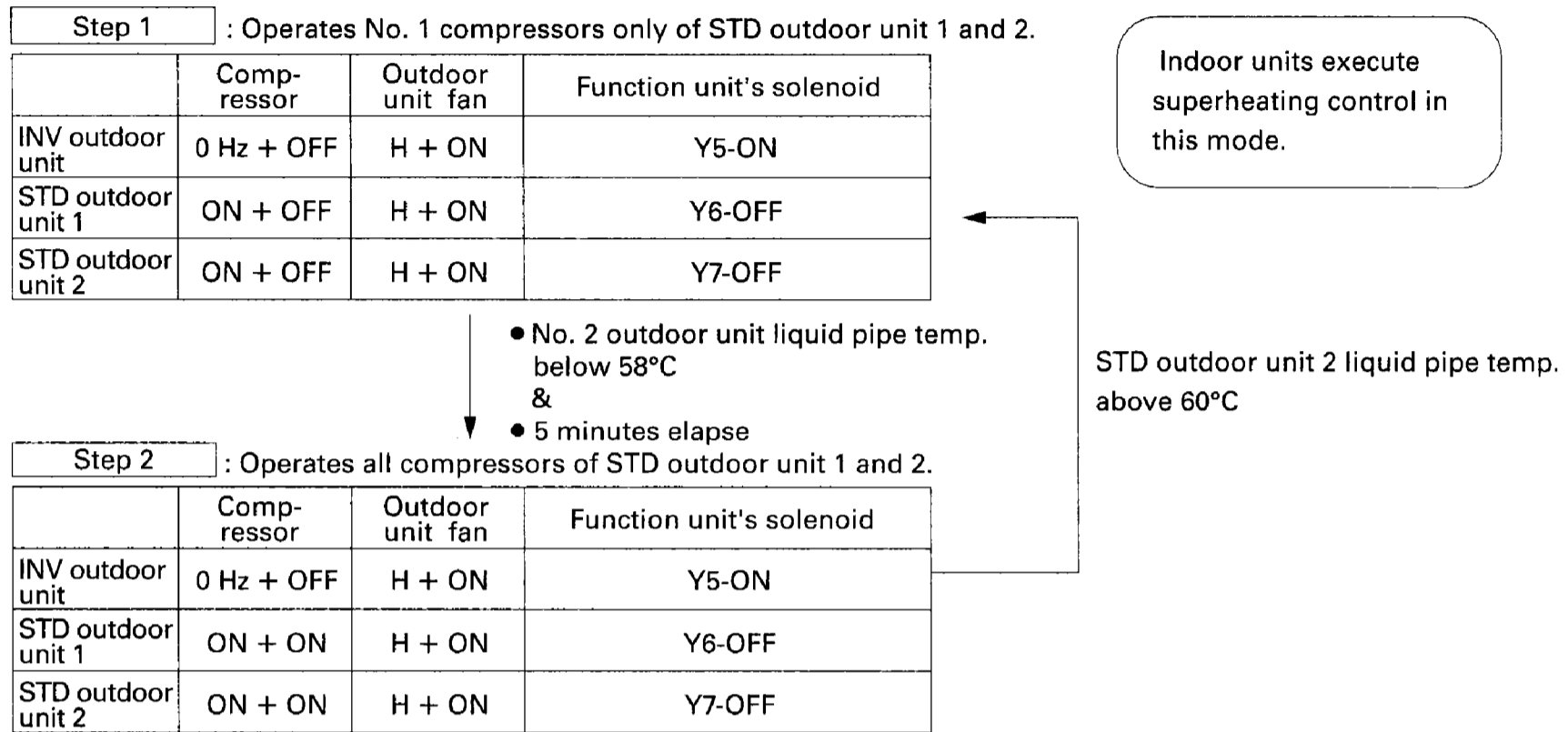

Pump down operation of STD outdoor unit

First fully close the liquid side and pressure equalizing side stop valves of the STD outdoor unit to be pumped down. The indoor unit fan is fixed at L tap.

- To pump down refrigerant of STD outdoor unit 1

Normal cooling operation is executed by INV outdoor unit and STD outdoor unit 2 only.

	Compressor	Outdoor unit fan	Function unit's solenoid
INV outdoor unit	P I control	H + ON	Low pressure protection control
STD outdoor unit 1	OFF	H + ON	Y6-ON
STD outdoor unit 2	P I control	H + ON	Low pressure protection control

Indoor units execute superheating control in this mode.

- To pump down refrigerant of STD outdoor unit 2:

Normal cooling operation is executed by INV outdoor unit and STD outdoor unit 1 only. Outdoor unit operation is same as STD outdoor unit 1.

# **TEST OPERATION**

## **PLUS Series**

# 1. Procedure and Outline

The operation sequence is the most important thing for test operation. Follow the following outline.

## (1) Check the following before turning power on.

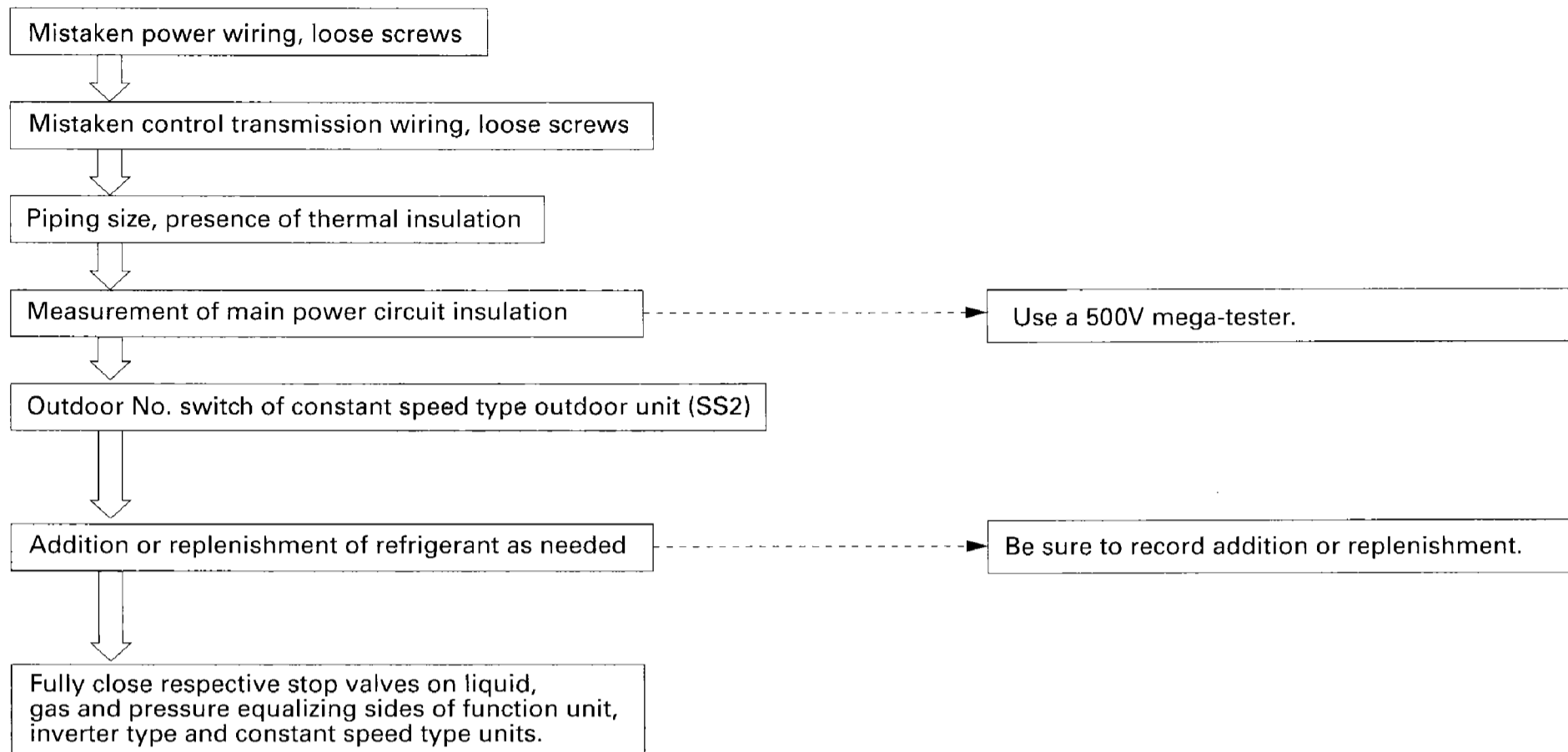

## (2) Turn power on.

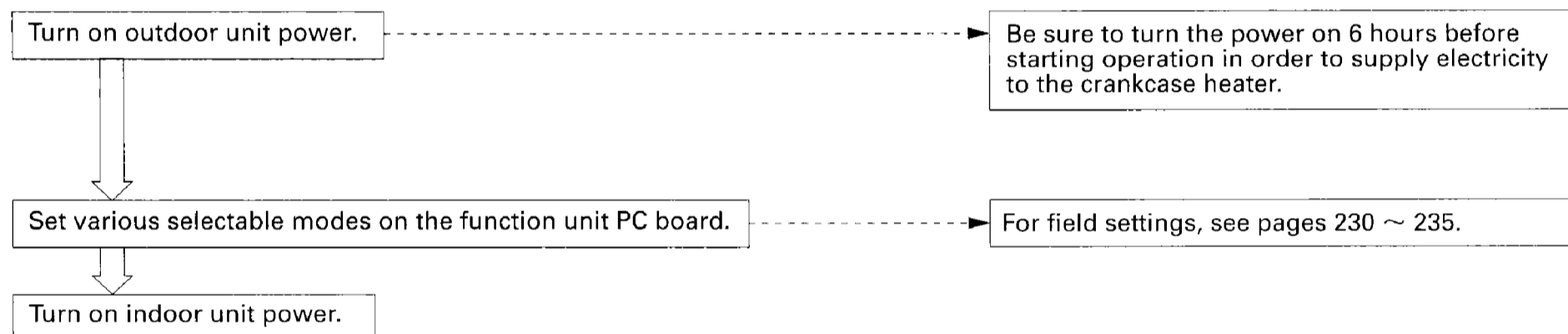

## (3) Check operation.

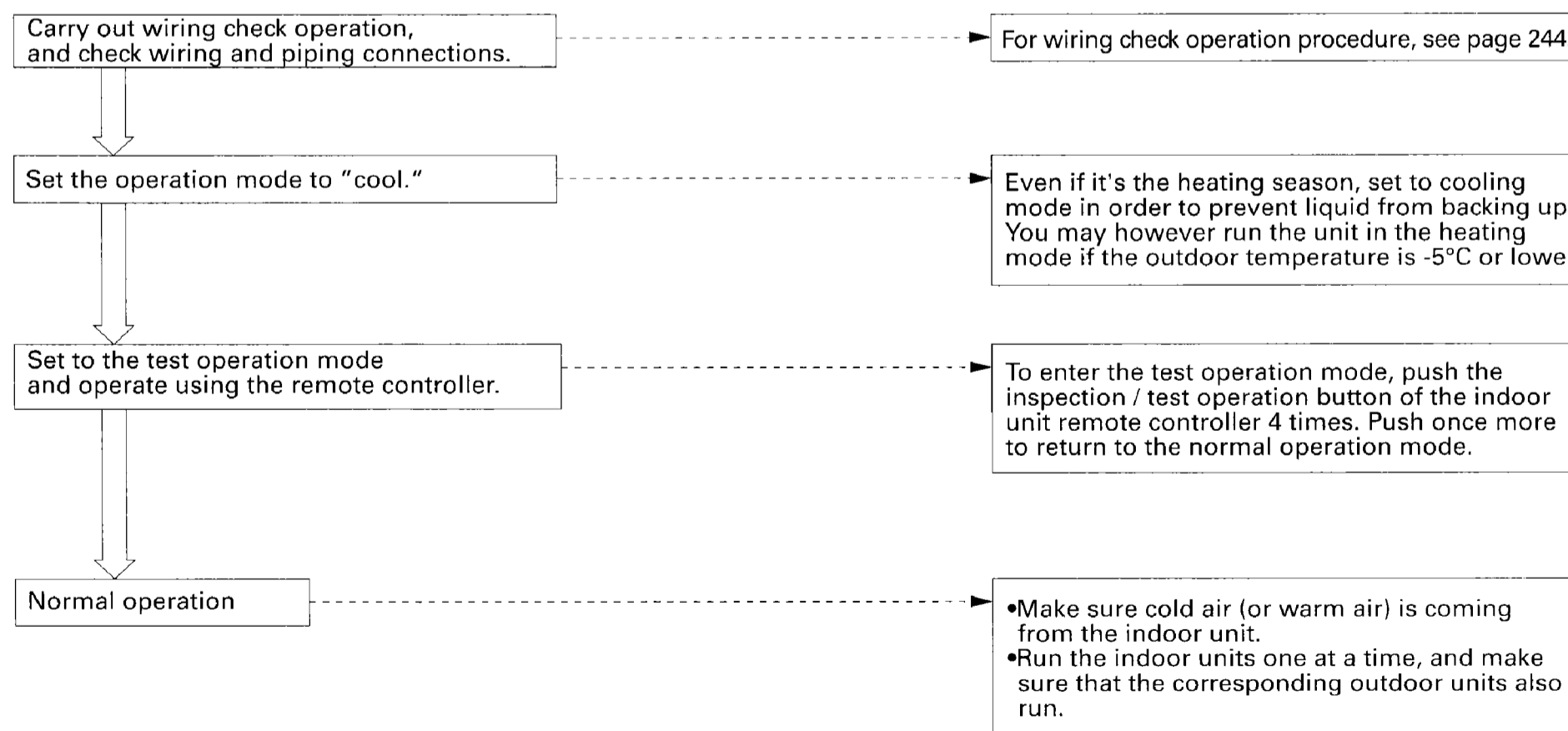

## 2. Operation When Power is Turned On

### ◆ When turning on power for first time

The unit cannot be run for up to 12 minutes to automatically set the master power and address (indoor-outdoor address, etc.).

- Function unit --- Test lamp (H2P) blinks  
Can also be set during operation described above.
- Outdoor unit --- Warning lamp (HWL) lights
- Indoor unit ----- If ON button is pushed during operation described above, the “UH” malfunction indicator blinks.  
(Returns to normal when automatic setting is complete.)

### ◆ When turning on power the second time and subsequent

Tap the wiring change button on the function unit PC board. Operation becomes possible after setting up for about 2 minutes. If you do not push the wiring change button, the unit cannot be run for up to 10 minutes to automatically set master power.

- Function unit --- Test lamp (H2P) blinks  
Can also be set during operation described above.
- Outdoor unit ----Warning lamp (HWL) lights
- Indoor unit ----- If ON button is pushed during operation described above, the operation lamp lights but the compressor does not operate. (Returns to normal when automatic setting is complete.)

### ◆ When an outdoor unit, indoor unit or BS unit has been added, or indoor unit PC Board has been changed

Be sure to push and hold the wiring change button for 5 seconds or longer. If not, the addition cannot be recognized. In this case, the unit cannot be run for up to 12 minutes to automatically set the address (indoor-outdoor address, etc.).

- Function unit --- Test lamp (H2P) goes off
- Outdoor unit --- Warning lamp (HWL) lights
- Indoor unit ----- If ON button is pushed during operation described above, the “UH” or “U4” malfunction indicator blinks.  
(Returns to normal when automatic setting is complete.)

#### 【NOTE】

Concerning compressor frequency when starting

Starting control is executed to stop operation frequency from rising to protect the compressor, and is carried out in accordance with the time elapsed since turning on the power, how long the compressors have been stopped, and outdoor temperature. The operating frequency of the compressor is held down during this time, and is not a malfunction.

(1) When cooling: Max. 7 minutes if outdoor temp. is low

(2) When heating: Max. 33 minutes if starting first time since turning power on  
Max. 15 minutes is starting second time or subsequent since turning power on

### 3. Outdoor Unit PC Board Ass'y

#### Function unit

BL

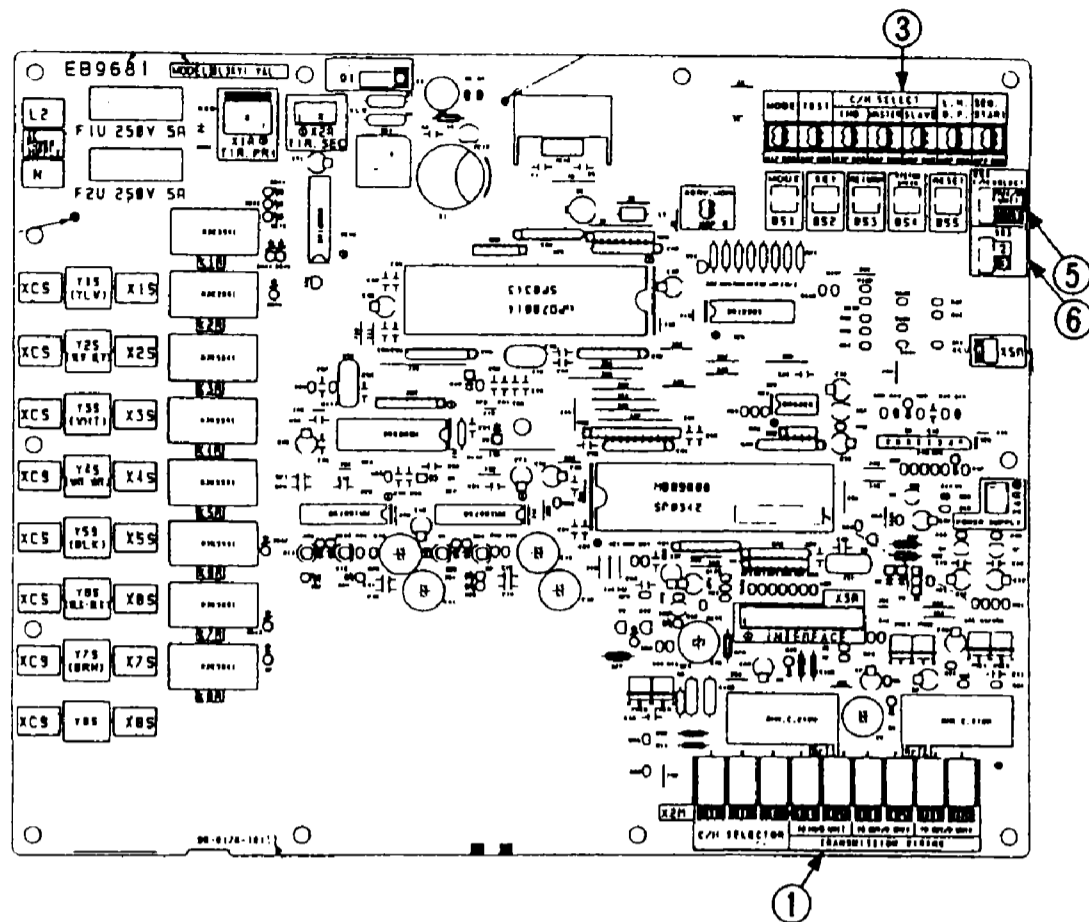

#### Outdoor unit (Inverter type)

RXY

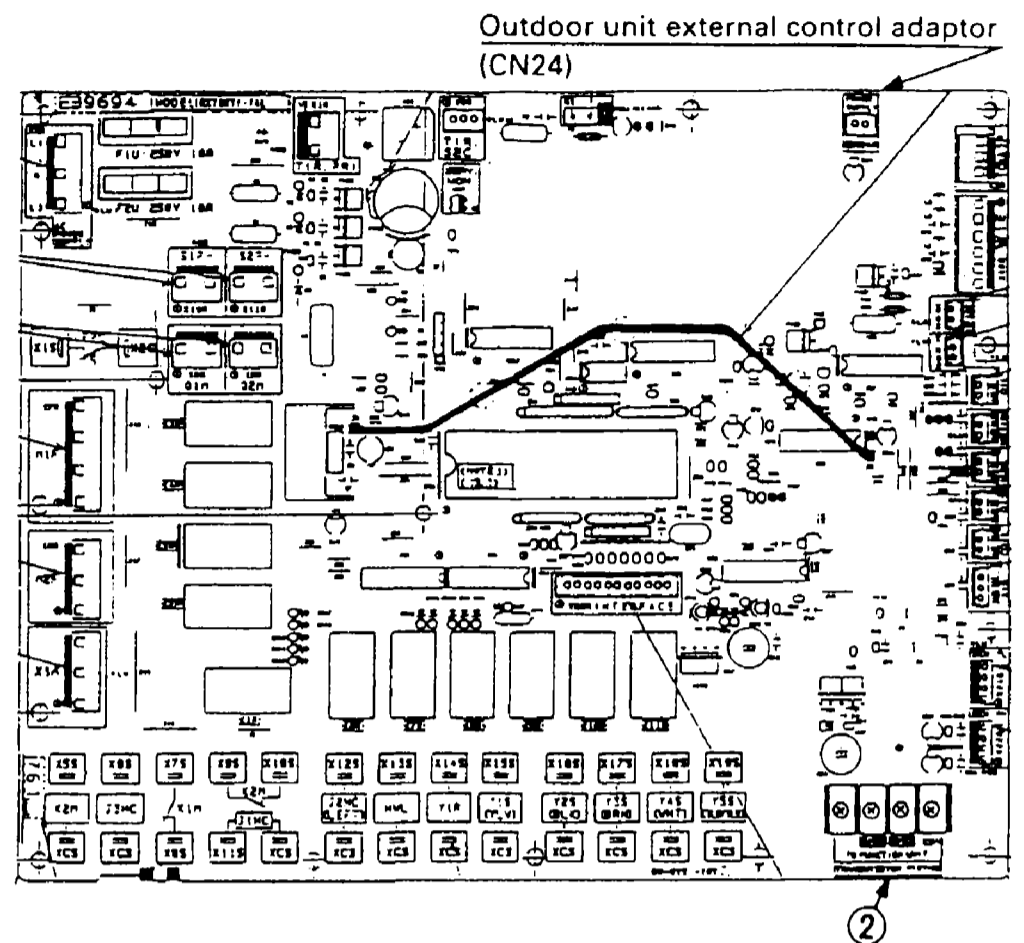

①	<p>Transmission terminal (Indoor unit, Cool/Heat selector) Outdoor - Outdoor</p> <p>Note: The R unit is not provided with the cool/heat select remote control terminals.</p>	
②	<p>Transmission terminal (Function unit - Each outdoor unit) Series connection</p>	
③	<p>Function of setting mode</p>	
④	<p>Outdoor unit No. setting (SS2)</p> <p>Note: This setting is not available on the inverter type</p>	<p>Presettable for constant-speed outdoor unit only 2: Second unit, 3: Third unit</p>
⑤	<p>Function of setting between cooling and heating (*Except for cooling only system)</p>	
⑥	<p>Outdoor unit connections setting (SS3)</p> <p>Note: This setting is not available on the BL2K and BR2K.</p>	<p>Set the number of outdoor units being connected.</p>



## 4. Switch Settings According to Number of Outdoor Units

The switches of the function unit and constant speed type outdoor unit PC boards must be set to match the number of outdoor units.

### (1) If there are 3 outdoor units:

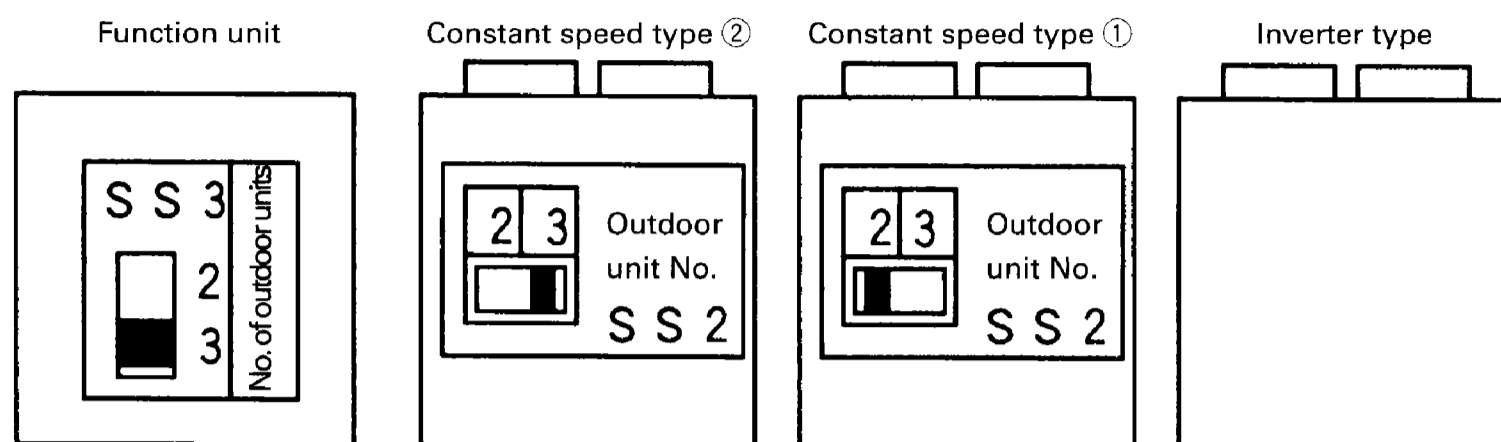

### (2) If there are 2 outdoor units:

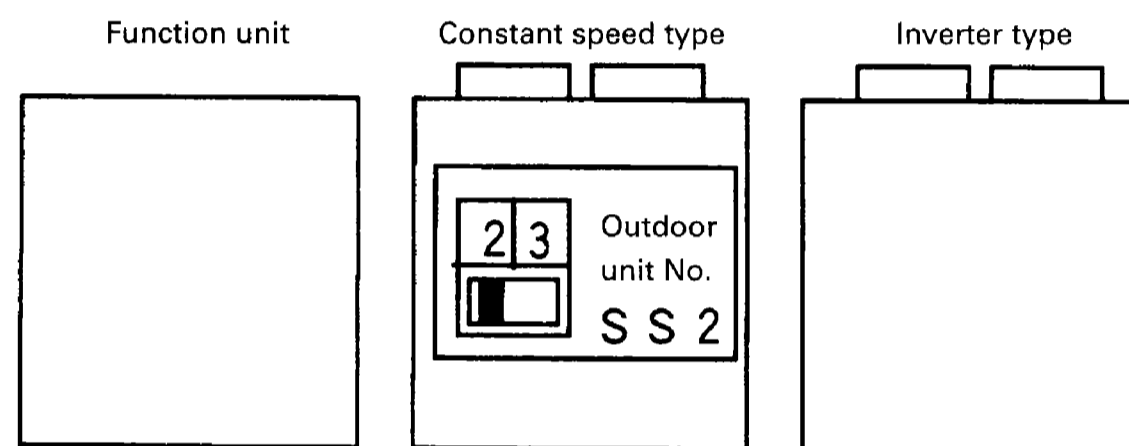

There is no switch for setting the number of outdoor units (SS3) for BL2K and BR2K.

NOTE: (1) Switch the switches described above before turning on the power.

(2) Factory settings

- Function unit switch for setting the number of outdoor units (SS3) ..... 3
- Constant speed type outdoor unit switch for setting the number of outdoor units (SS2) ..... 2

## 5. Setting Modes

There are the following three setting modes.

- ① Setting mode 1 (H1P off): Used to select the cool/heat setting, low-noise run and sequential start.
- ② Setting mode 2 (H1P on): Used to modify the running status and to program addresses, etc. Usually used in servicing the system.
- ③ Monitor mode (H1P flashing): Used to check the programs made in the setting modes, the number of units being connected, and other entries.

### Functions of pushbutton switches

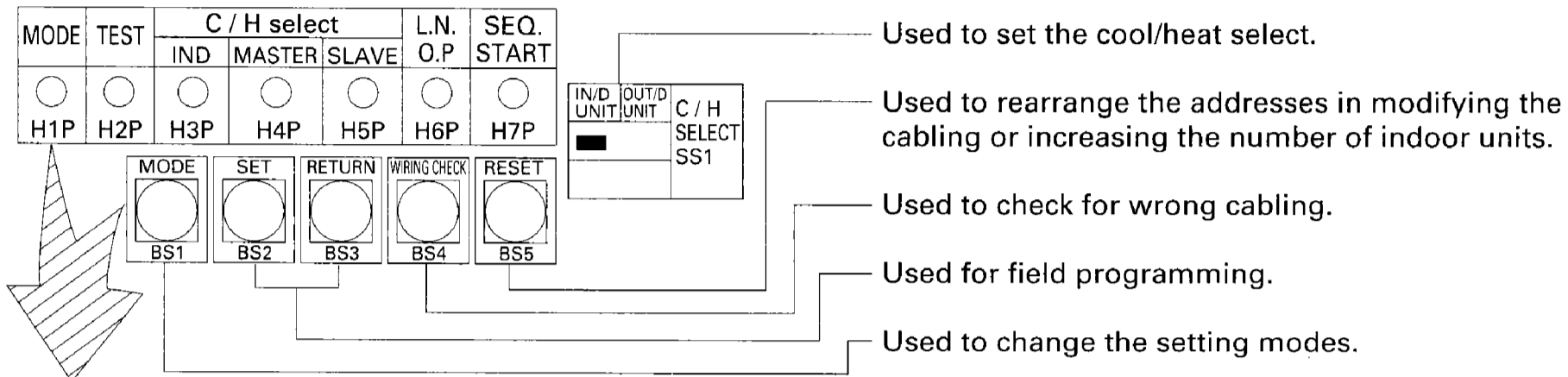

### Mode change

Using the MODE button, the modes can be changed as follows.

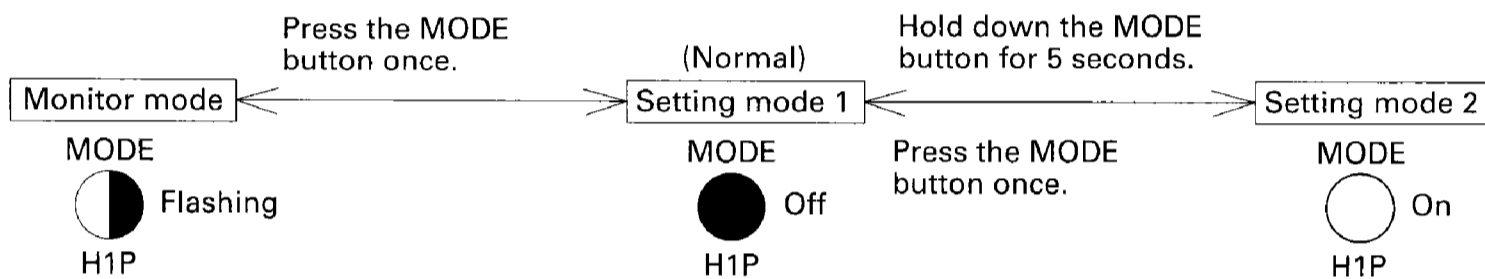

### Mode changing procedure

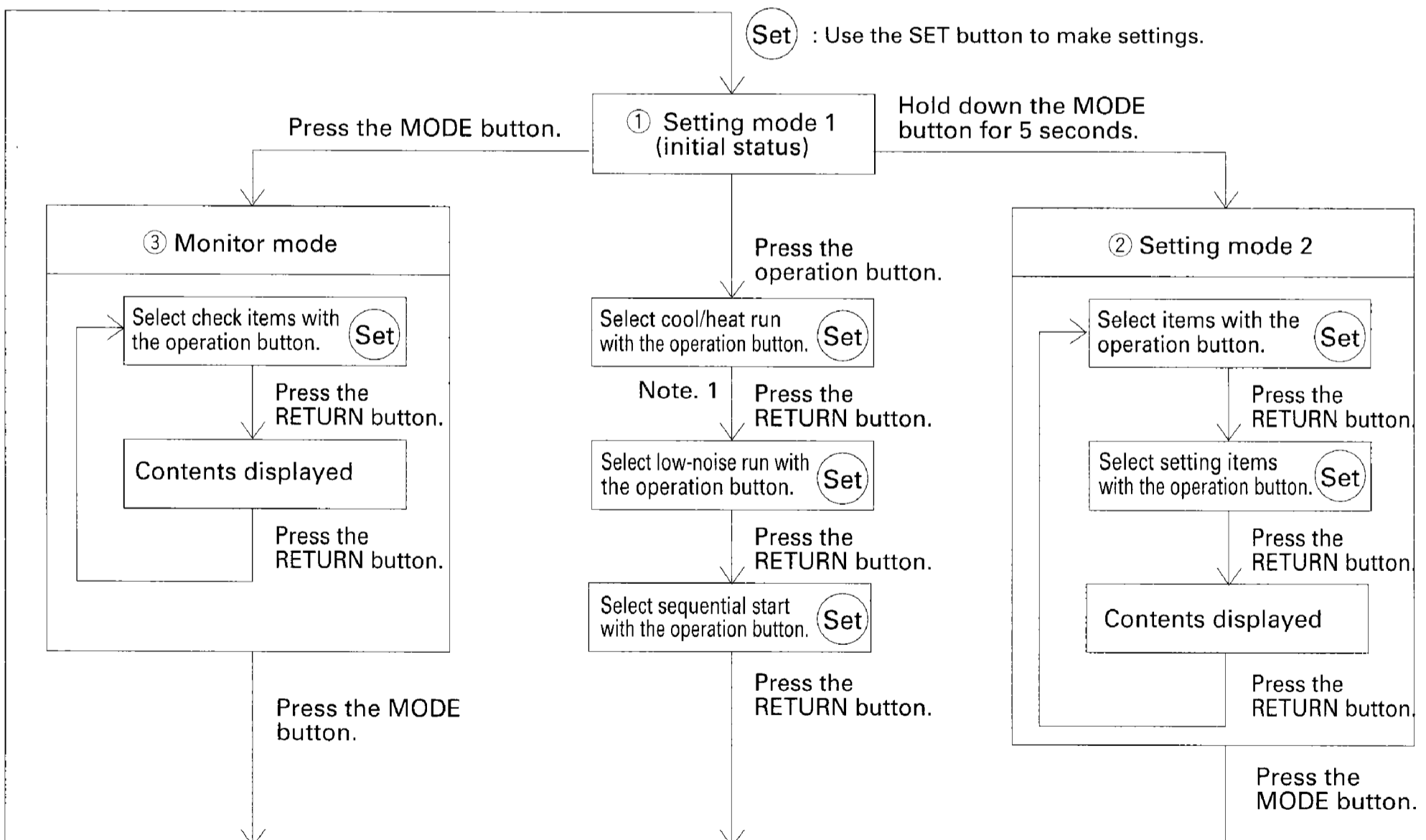

Note. 1: No cool/heat selection for cooling only system

# (1) Setting Mode 1

Cool/heat selection setting (SS1) If carried out from the indoor unit remote controller: If carried out from the cool/heat selector:

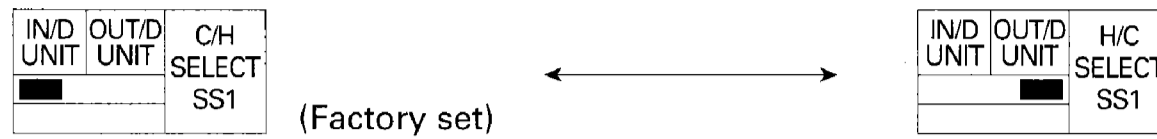

(Factory set)

MODE	TEST	C/H SELECT			L.N.O.P.	SEQ. START
		IND	MASTER	SLAVE		
●	●	○	●	●	●	○
H1P	H2P	H3P	H4P	H5P	H6P	H7P

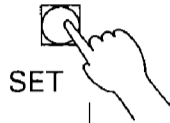

The factory settings are:

Individual (C/H SELECT), OFF (L.N.O.P.), ON (SEQ. START)

You can change the cool/heat selection permission, low noise and sequential start settings by pushing the SET switch.

To skip settings you don't want to change, push the RETURN switch and go to the next setting.

Change cool/heat selection to MASTER.

An optional adaptor for outside control of outdoor units is required if you have set cool/heat selection to MASTER or SLAVE.

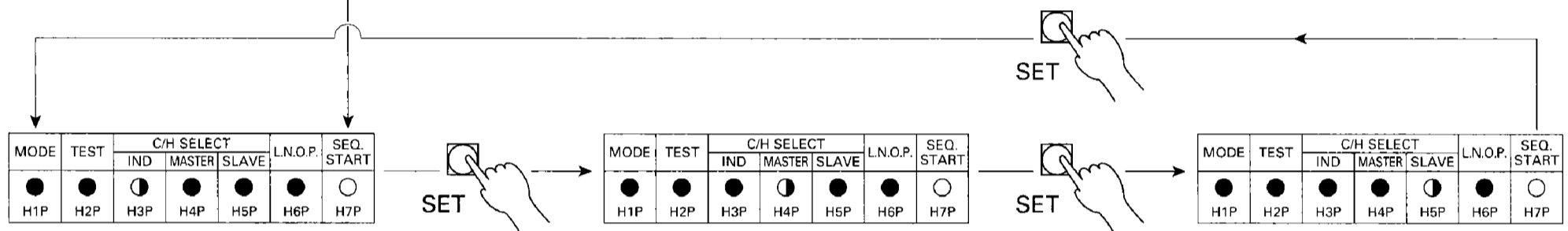

Change low noise operation to "ON".

External control adaptor for outdoor unit is required if low noise operation is set to "ON".

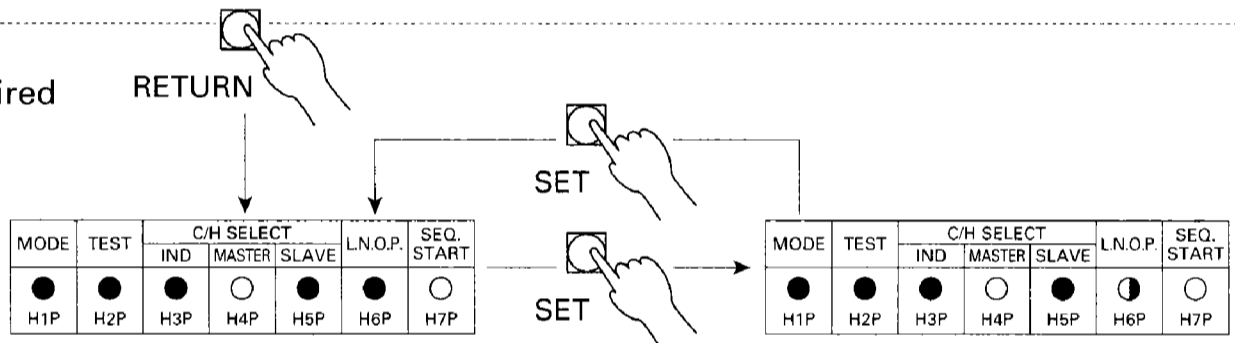

Change sequential start to "OFF".

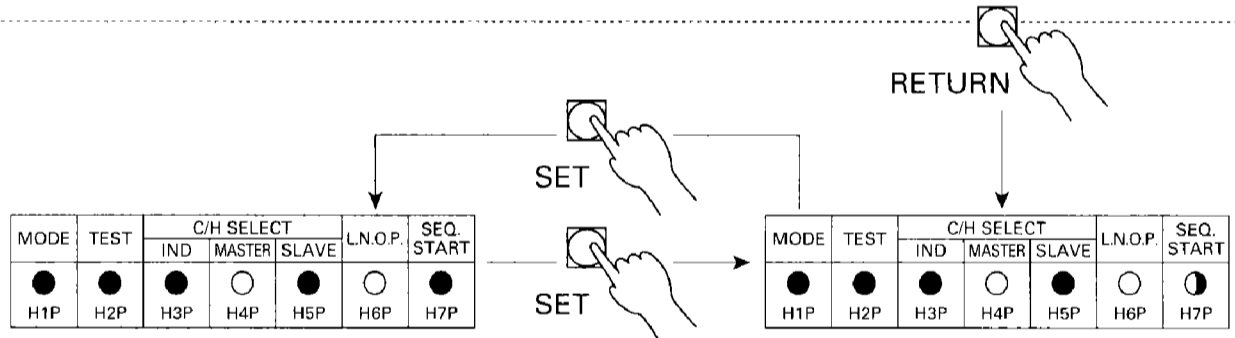

Setting complete  
GROUP MASTER (cool/heat selection),  
ON (low noise), OFF (sequential start)

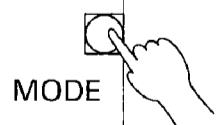
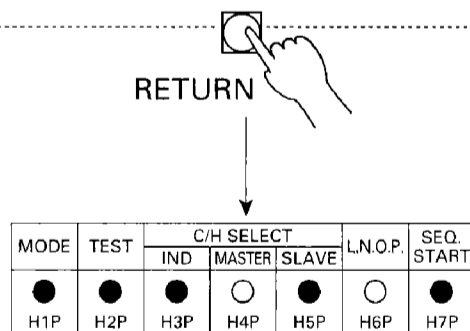

Monitor mode

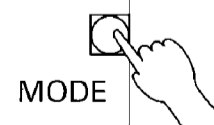

Push and hold for 5 sec.

Setting mode 2

NOTE : External control adaptor for outdoor unit is required if cool/heat selection set to MASTER or SLAVE, or if low noise operation is set to ON.

## (2) Setting Mode 2

To switch from setting mode 1 (normal) to setting mode 2, you must push and hold the next page button (BS1) for 5 seconds. (You cannot enter setting mode 2 while setting mode 1 is set.)

### Setting procedure

① Push the SET button and match with the setting item (LED display). (All 10 settings)



② Push the RETURN button (BS3) and the present settings flicker (LED display).



③ Push the SET button (BS2) and match with each setting (LED flicker display).



④ Push the RETURN button (BS3) and enter the settings.



⑤ Push the RETURN button (BS3) and return to the initial status.

Note: ● If you become unsure of how to proceed, push the MODE button (BS1) and return to setting mode 1.

● The initial status of setting mode 2 is the status of setting item No. 1 in mode 2.

### Setting items

	Setting item	Description	LED display							LED display																														
			H1P	H2P	H3P	H4P	H5P	H6P	H7P	H1P	H2P	H3P	H4P	H5P	H6P	H7P																								
1	EMG (Emergency operation 1)	Emergency operation when inverter type outdoor unit malfunctions.	○	●	●	●	●	●	●	Emergency operation (Operates by constant speed outdoor unit only.)	○	●	●	●	●	○	●	Normal operation	○	●	●	●	●	○																
2	Cool/heat unified address	Address for cool/heat unified operation	○	●	●	●	●	○	○	Address	0	○	●	●	●	●	○	Binary number (5 digits)	1	○	●	●	●	○	○	2	○	●	●	●	○	○	31	○	●	○	○	○	○	
3	Low noise / demand address	Address for low noise / demand operation.	○	●	●	●	○	○	○	Address	0	○	●	●	●	○	○	Binary number (5 digits)	1	○	●	●	●	○	○	2	○	●	●	●	○	○	31	○	●	○	○	○	○	
4	Forced fan switch	Indoor unit fan turns while unit is stopped.	○	●	●	○	○	○	○	Forced fan operation (H tap)	○	●	●	●	○	○	○	Normal operation	○	●	●	●	○	○																
5	Indoor unit forced operation	Allows operation of indoor unit from outdoor unit.	○	●	●	○	○	○	○	Indoor unit forced operation	○	●	●	●	○	○	○	Normal operation	○	●	●	●	○	○																
6	Frequency fix	Fixes compressor frequency. INV : (60Hz+OFF) STD1: (ON+OFF) STD2: (ON+OFF)	○	●	●	○	○	○	○	Frequency fix	○	●	●	●	○	○	○	Normal operation	○	●	●	●	○	○																
7	TE setting	Low pressure setting for cooling.	○	●	○	○	○	○	○	High	○	●	●	○	○	○	○	Normal (factory set)	○	●	●	○	○	○	○															
8	TC setting	High pressure setting for heating	○	●	○	○	○	○	○	Low	○	●	●	○	○	○	○	Note 1	○	●	●	○	○	○	○															
9	Defrost setting	Temperature setting for defrost.	○	●	○	○	○	○	○	Quick defrost	○	●	●	○	○	○	○	Normal (factory set)	○	●	●	○	○	○	○	Slow defrost	○	●	●	○	○	○	○							
10	Air NET address	Address for Air NET	○	●	○	○	○	○	○	Address	0	○	●	●	●	○	○	Binary number (6 digits)	1	○	●	●	●	○	○	2	○	●	●	●	○	○	63	○	○	○	○	○	○	○
11	Pump down operation 1	Pump down operation of INV outdoor unit.	○	●	○	○	○	○	○	Pump down operation	○	●	●	○	○	○	○	Normal operation	○	●	●	○	○	○	○															
12	Pump down operation 2	Pump down operation of STD 1 outdoor unit.	○	●	○	○	○	○	○	Pump down operation	○	●	●	○	○	○	○	Normal operation	○	●	●	○	○	○	○															
13	Pump down operation 3	Pump down operation of STD 2 outdoor unit.	○	●	○	○	○	○	○	Normal operation	○	●	●	○	○	○	○																							
14	Forced backup operation (Emergency operation 2)	Executes emergency operation when constant speed outdoor unit is faulty.	○	●	○	○	○	○	○	When constant speed outdoor unit 2 is faulty:	○	●	●	○	○	○	○	When constant speed outdoor unit 1 is faulty:	○	●	●	○	○	○	○	Normal operation	○	●	●	○	○	○	○							

Note1: TC setting and Defrost setting are not applicable to cooling only system.

No	Setting item	Description	LED display H1P H2P H3P H4P H5P H6P H7P	LED display H1P H2P H3P H4P H5P H6P H7P	LED display H1P H2P H3P H4P H5P H6P H7P
1	EMG (Emergency operation 1)	Emergency operation when Inverter type outdoor unit malfunctions.		Emergency operation Normal operation	
2	Cool/heat unified address	Address for cool/heat unified operation		Address 0 Binary number 1 (6 digits) 2 31	
3	Low noise / demand address	Address for low noise / demand operation		Address 0 Binary number 1 (6 digits) 2 31	
4	Forced fan switch	Indoor unit fan turns while unit is stopped.		Forced fan operation (H tap) Normal operation	
5	Indoor unit forced operation	Allows operation of indoor unit from outdoor unit		Forced fan operation (H tap) Normal operation	
6	Frequency fix	Fixes compressor frequency. INV : (60Hz +OFF) STD 1 : (ON+OFF) STD 2 : (ON+OFF)		Frequency fix Normal operation	
7	TE setting	Low pressure setting for cooling		High Normal (factory set) Low	
8	TC setting Note 1	High pressure setting for heating			
9	Defrost setting Note 1	Temperature setting for defrost		Quick defrost Normal (factory set) Slow defrost	
10	Air Net address	Address for Air Net		Address 0 Binary number 1 (6 digits) 2 63	
11	Pump down operation 1	Pump down operation of INV outdoor unit		Pump down operation Normal operation	
12	Pump down operation 2	Pump down operation of STD 1 outdoor unit			
13	Pump down operation 3	Pump down operation of STD 2 outdoor unit			
14	Forced back up operation (Emergency operation 2)	Executes emergency operation when constant speed outdoor unit is faulty.		Constant speed outdoor unit 2 has broken Constant speed outdoor unit 1 has broken Normal operation	

Initial setting (EMG)

Initial setting (EMG)

RETURN BUTTON  
 SET BUTTON

### (3) Monitor Mode

MODE	TEST	C/H SELECT			L.N.O.P.	SEQ. START
		IND	MASTER	SLAVE		
● H1P	● H2P	○ H3P	● H4P	● H5P	● H6P	○ H7P

To enter the monitor mode, push the MODE button when in setting mode 1.

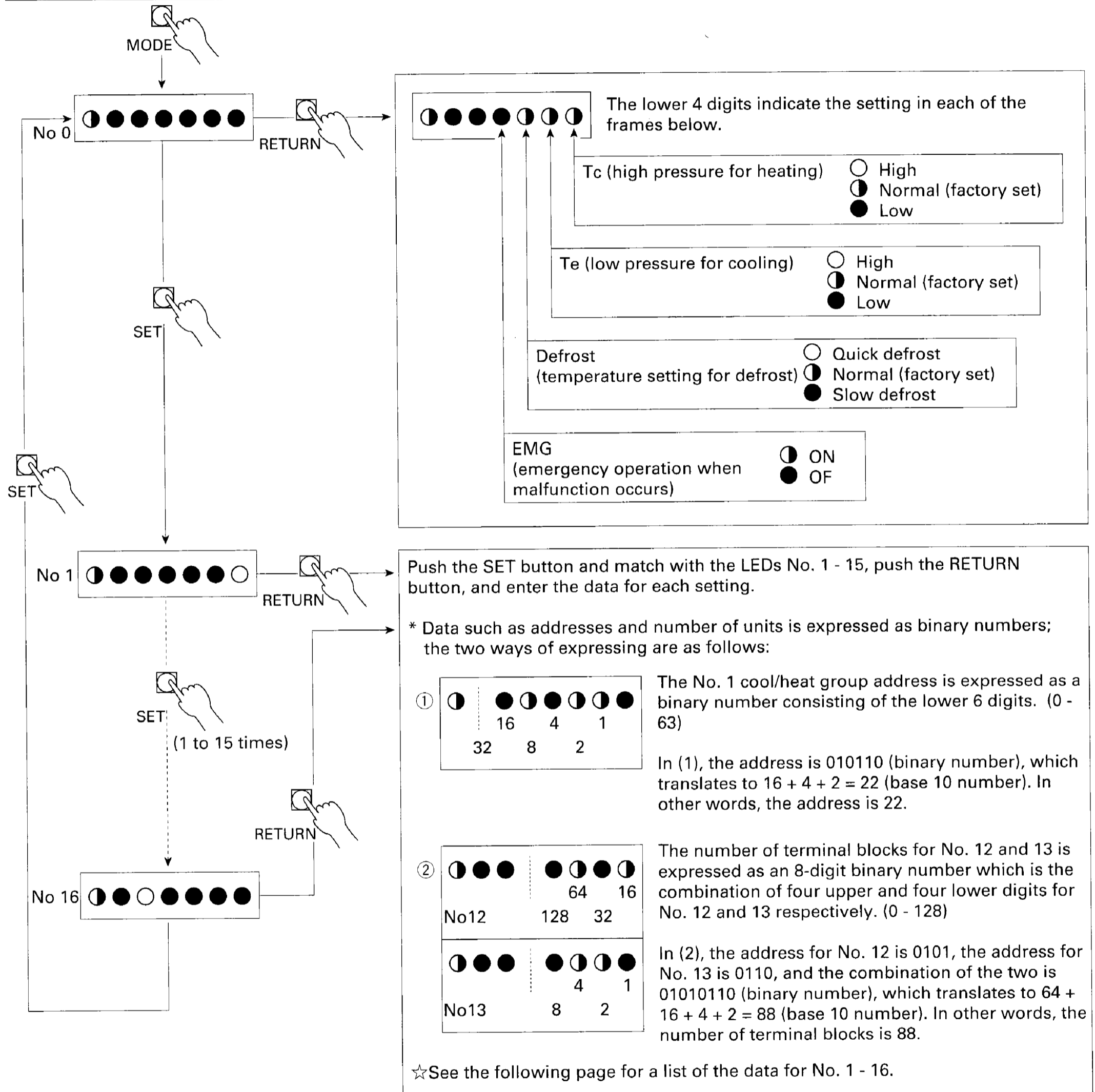

☆ After making sure the data is correct, push the RETURN button and return to No. 0, or push the MODE button and return to setting mode 1.

• **Monitor Mode Data**

Mode No.	LED	Data	Display method	Size (binary number)
No 1	● ● ● ● ● ● ○	Cool/heat group address	0 ~ 31	Lower 6 digits
No 2	● ● ● ● ● ○ ●	Low noise / demand address	0 ~ 31	Lower 6 digits
No 3	● ● ● ● ● ○ ○	Not used		
No 4	● ● ● ● ○ ● ●	Not used	0 ~ 63	Lower 6 digits
No 5	● ● ● ● ○ ● ○	Number of connected units	0 ~ 63 units	Lower 6 digits
No 6	● ● ● ● ○ ○ ●	Number of connected BS units	0 ~ 63 units	Lower 6 digits
No 7	● ● ● ● ○ ○ ○	Number of connected zone units (excluding outdoor and BS units)	0 ~ 63 units	Lower 6 digits
No 8	● ● ● ○ ● ● ●	Number of outdoor units	0 ~ 63 units	Lower 6 digits
No 9	● ● ● ○ ● ● ○	Number of BS units	0 ~ 128 units	Lower 4 digits, upper
No 10	● ● ● ○ ● ○ ●	Number of BS units	0 ~ 128 units	Lower 4 digits, lower
No 11	● ● ● ○ ● ○ ○	Number of zone units (excluding outdoor and BS units)	0 ~ 63 units	Lower 6 digits
No 12	● ● ● ○ ○ ● ●	Number of terminal blocks	0 ~ 128 units	Lower 4 digits, upper
No 13	● ● ● ○ ○ ● ○	Number of terminal blocks	0 ~ 128 units	Lower 4 digits, lower
No 14	● ● ● ○ ○ ○ ●	Not used		
No 15	● ● ● ○ ○ ○ ○	Not used		
No 16	● ● ○ ● ● ● ●	Not used		

## 6. Sequential Start

- Separates path timing of commercial power supply compressors by 3 seconds each in order to prevent overcurrent when more than 1 compressor are to be started at the same time.
- Improved wiring system enables sequential start of up to 5 function units and 10 outdoor units.

If you want to carry out sequential start, connect outdoor unit - outdoor unit transmission wiring as shown below. The function unit PC board (EC) is factory set to "sequential start."

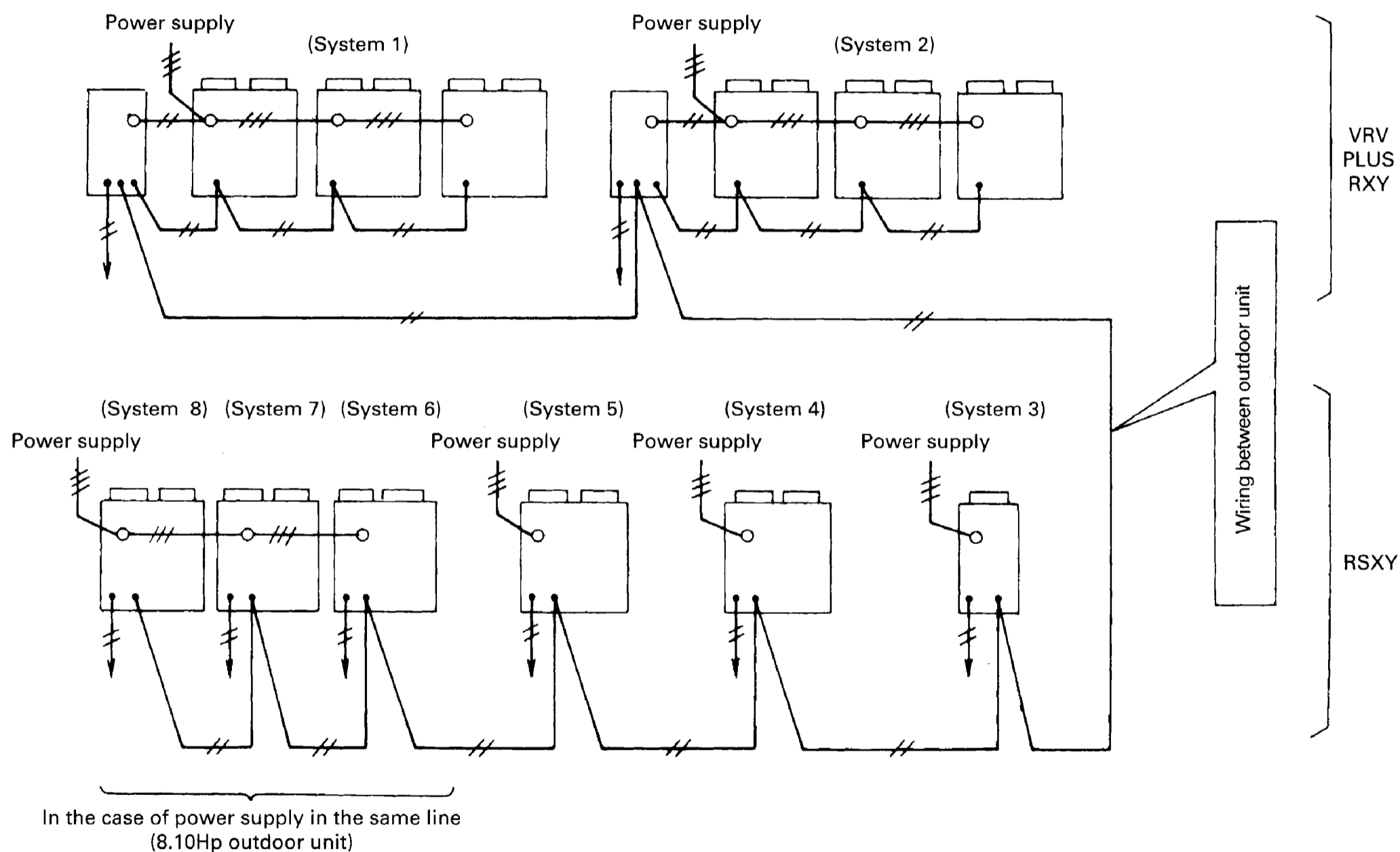
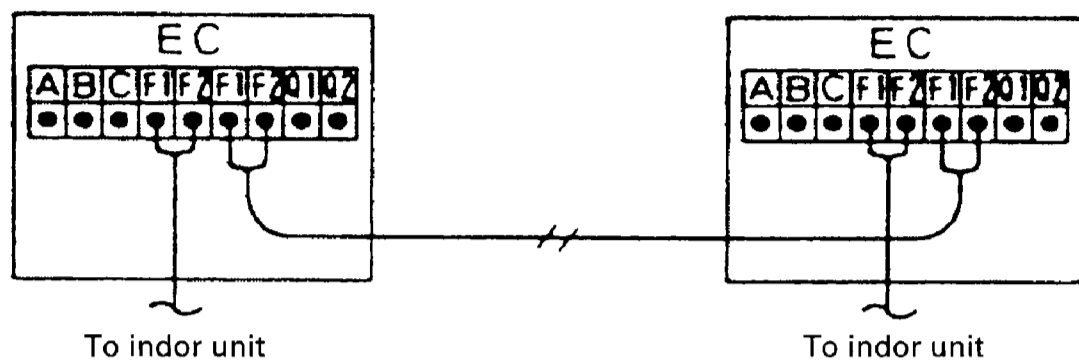



## 7. External Control Adaptor for Outdoor Units (DTA104A61-DTA104A62)

<Objective/use>

By adding an adaptor for outside control of outdoor units to BS units or indoor units connected in a DIII-NET, you can simultaneously select cool/heat mode for several outdoor units in the system, and it enables demand control and low noise control.

### ■ Part names and functions

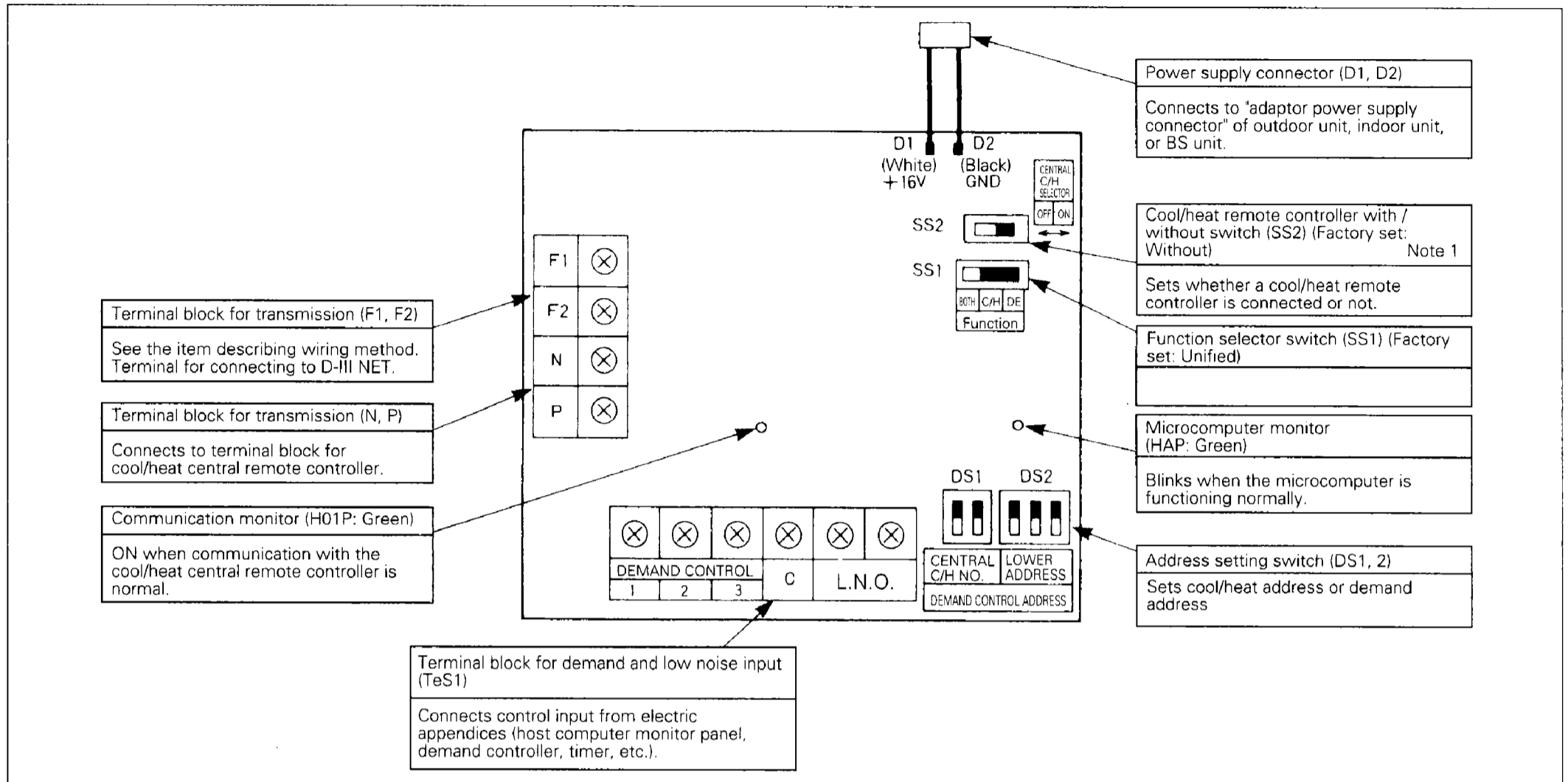

Note 1: SS2 is not applicable to cooling only system.

### (1) Cool/heat mode unified selection (For detailed example of wiring, see the page describing cool/heat mode control.)

<System outline>

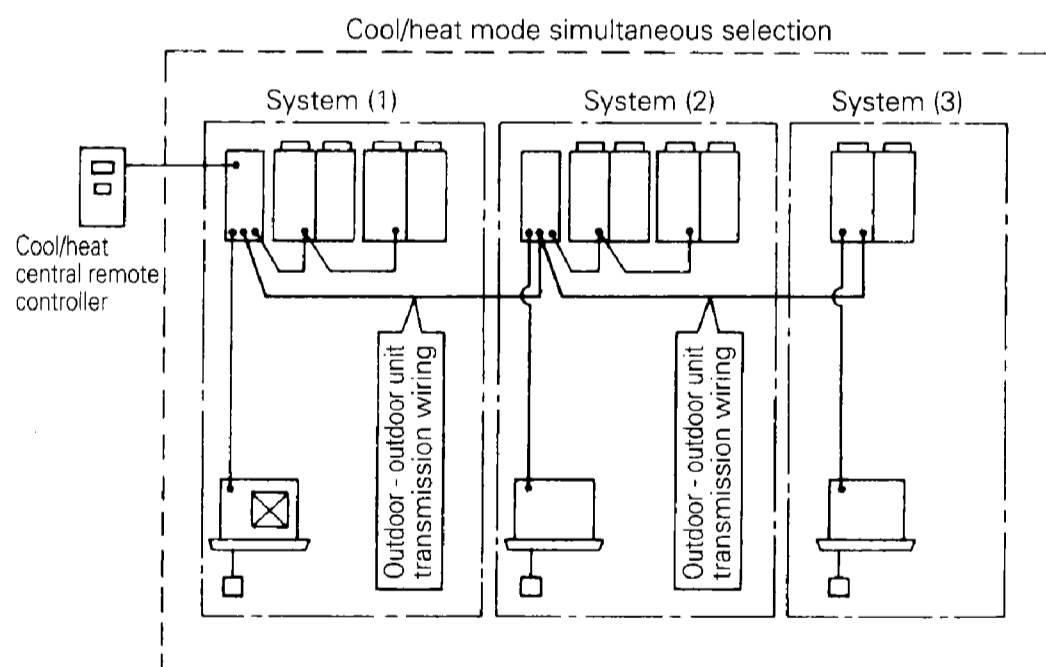

<Settings of switches on the PC board adaptor>

- SS1: C / H ("BOTH" is selected when demand control is carried out at the same time.)
- SS2: OFF
- DS1-2: Set the same address as the cool/heat mode address of the function unit.

<NOTE>

- Set the SS1 cool/heat selector switch on the function unit to "outdoor." You must also set cool/heat selector "master" or "slave" by pushbutton switch.

## (2) Demand / low noise control (※ Except for Cooling only system)

Connecting control input to the adaptor for outside control of outdoor units enables demand and low noise control.

### ■ Demand control (figures indicate demand rate)

When short circuit between (1) and (C): Approx. 70% as a guideline

When short circuit between (2) and (C): Approx. 40% as a guideline

When short circuit between (3) and (C): Forced fan operation

### ■ Low noise control (Outdoor unit)

Running noise can be reduced by 2~3dB by controlling capacity of outdoor unit.

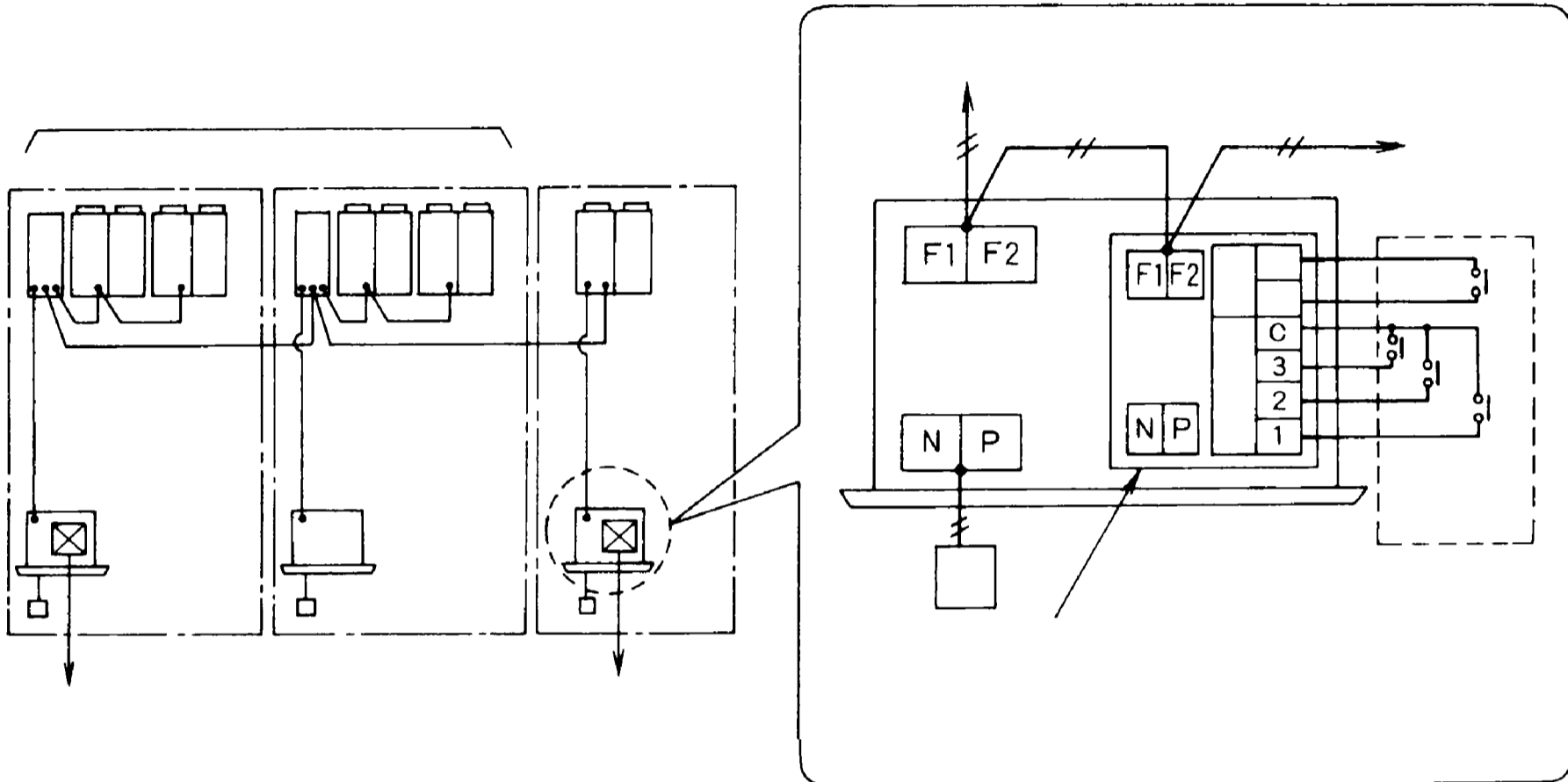

### 【Common】

#### <Address setting (DS1 / DS2)>

Decide the address for each control unit from 0~9 and set.

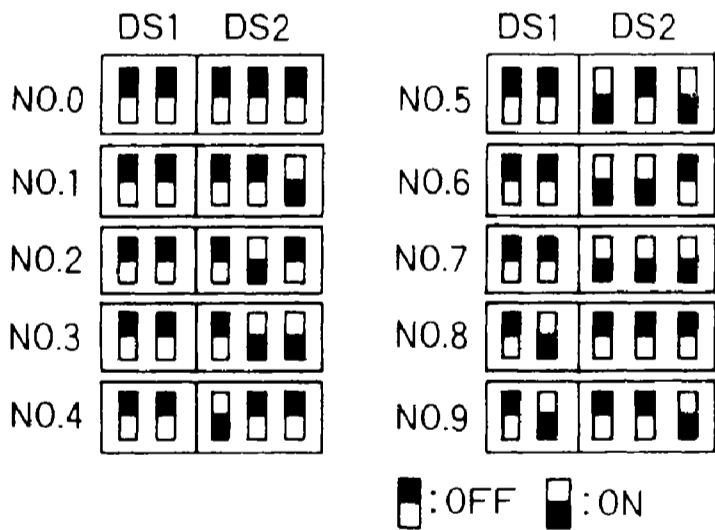

### NOTES

- Setting is within 8 groups when using a cool/heat central remote controller. Set from No. 0~No. 7.
- Be sure to make the address No. of the PC board adaptor described above match the address No. of function unit or outdoor unit (BS unit if using cool/heat simultaneous selection type).  
(For detailed settings, see the installation manual.)

#### <Control input specifications>

### ■ Input signal

Constant contact a

Input current is approx. 12 - 24 VDC, 10 mA per contact.

Use a micro-current contact for the relay contact.

(Max. 12 VDC, 1 mA)

### ■ Outside wiring specifications

Recommended electric wiring: Sheathed vinyl cord or cable  
0.75~1.25 mm<sup>2</sup> (double core)

Wiring length: Max. 150 m

Run separate from power line in order to prevent malfunction.

## 8. Cool/Heat Mode Switching (※Except for cooling only system)

The VRV PLUS Series cool/heat switching system offers the following 4 cool/heat modes.

- ① Set cool/heat separately for each outdoor system by indoor unit remote controller.
- ② Set cool/heat separately for each outdoor system by cool/heat selector.
- ③ Set cool/heat for more than one outdoor unit system simultaneously in accordance with unified master outdoor unit by indoor unit remote controller.
- ④ Set cool/heat for more than one outdoor unit system simultaneously in accordance with unified master outdoor unit by cool/heat selector.

Details of each setting mode are explained below.

(For modes ③ and ④, perform power supply reset of the outdoor unit external control adaptor after changing the setting.)

### ① Set cool/heat separately for each outdoor system by indoor unit remote controller.

- It doesn't matter whether or not there is outdoor - outdoor unit wiring.
- Set function unit PC board SS1 to "indoor" (factory set).
- Set cool/heat switching to "individual" for setting mode 1 (factory set).

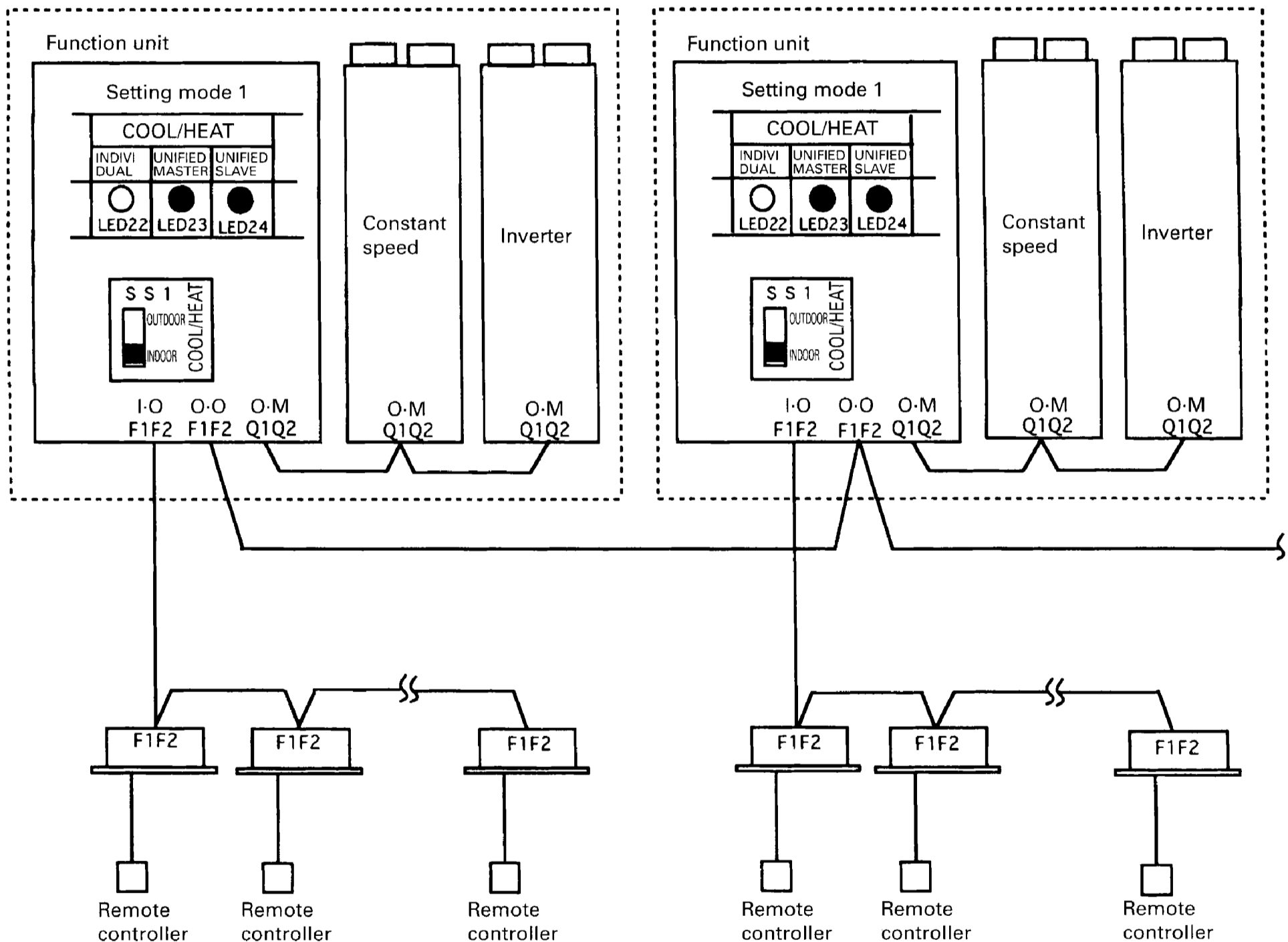

One of the remote controllers is given cool/heat selection permission.

One of the remote controllers is given cool/heat selection permission.

② **Set cool/heat separately for each outdoor system by C/H SELECTOR.**

- It doesn't matter whether or not there is outdoor - outdoor unit wiring.
- Set function unit PC board SS1 to "outdoor".
- Set cool/heat switching to "individual" for setting mode 1 (factory set).

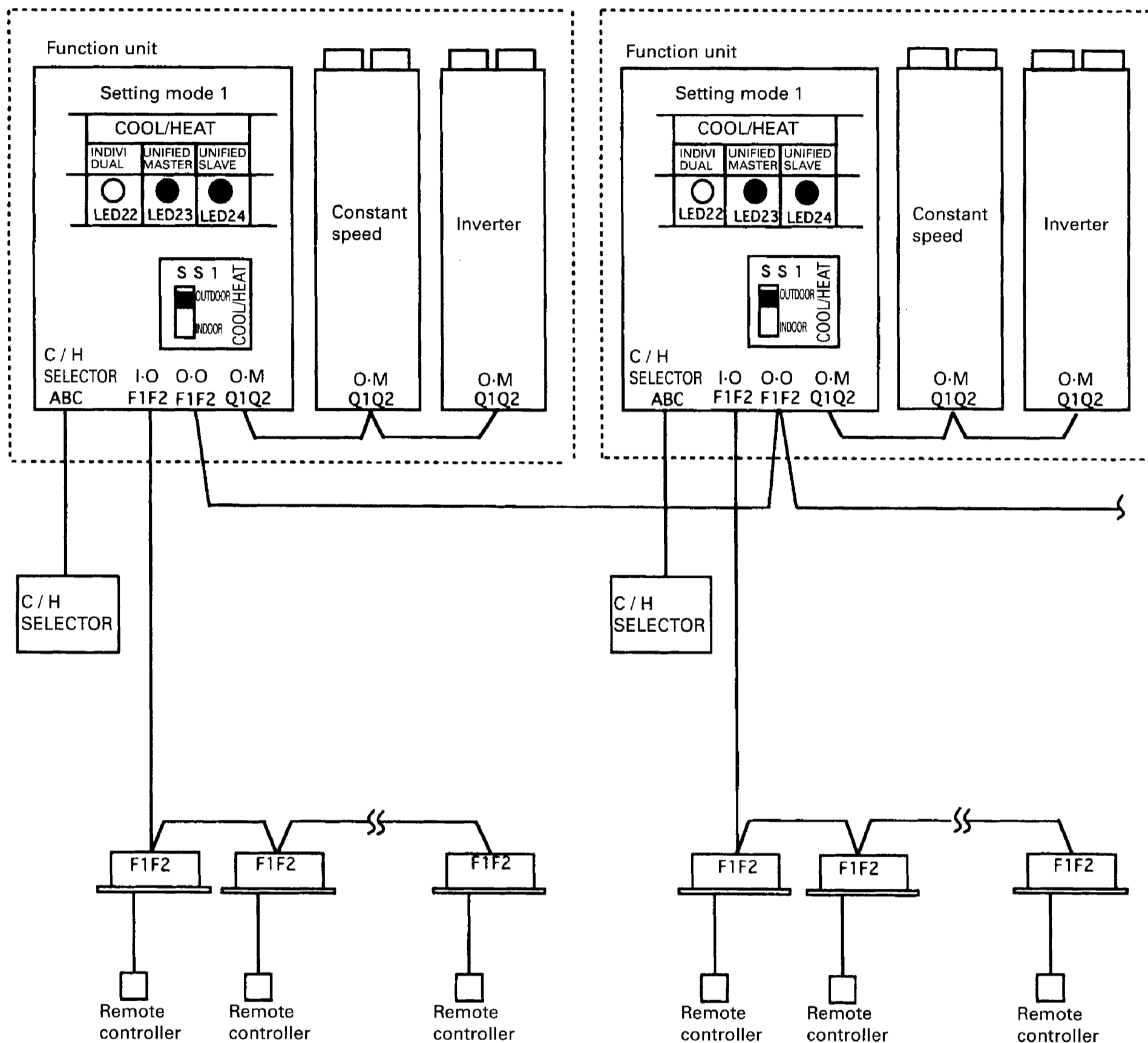

③ **Setting of cool/heat by outdoor unit system group in accordance with group master outdoor unit by indoor unit remote controller**

- Install the External control adaptor for outdoor unit on either the outdoor - outdoor, indoor - outdoor, or indoor - indoor transmission line.
- Set SS1 of the outdoor unit PCB to "IN / D UNIT" (factory set).
- In setting mode 1, set the outdoor unit you want to give cool/heat selection permission to as the group master, and set the other outdoor units as group slave units.

**UNIFIED MASTER**

**UNIFIED SLAVE**

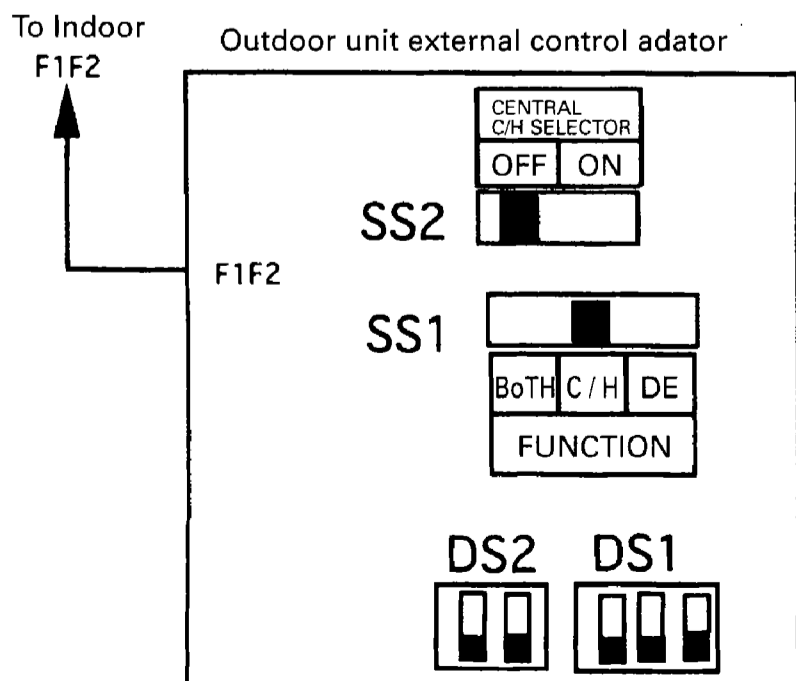
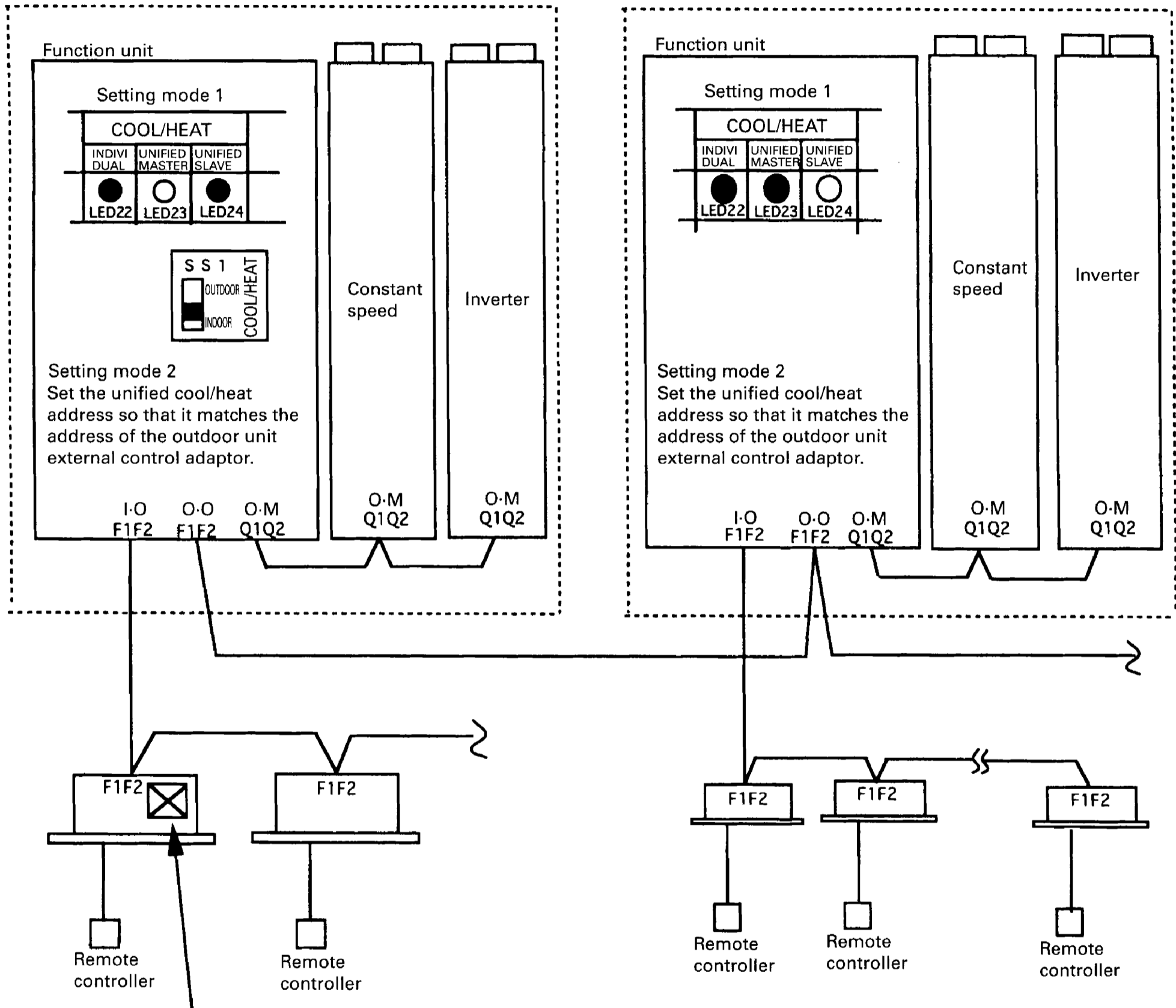

· DS 1 · DS 2 : Address setting  
Set the address so that it matches the unified cool/heat address of the function unit.

## 9. Low Noise Operation

By connecting the external contact input to the low noise input of the outdoor unit external control adaptor for outdoor unit (optional), you can save power and lower operating noise by 2 -3 dB.

### 1. Outdoor unit field setting

- Setting mode 1: Set low noise operation to "ON."
- Setting mode 2: Match low noise operation and demand control address with address of outdoor unit external control adaptor.

### 2. Outdoor unit external control adaptor setting

- Function switch (SS1)  
Set to "BOTH" or "DE."
- Address setting switches (DS1, DS2)  
Match with outdoor unit low noise operation and demand control address.

### 3. Short-circuit the low noise input of outdoor unit external control adaptor for outdoor unit.

[Low noise control system example]

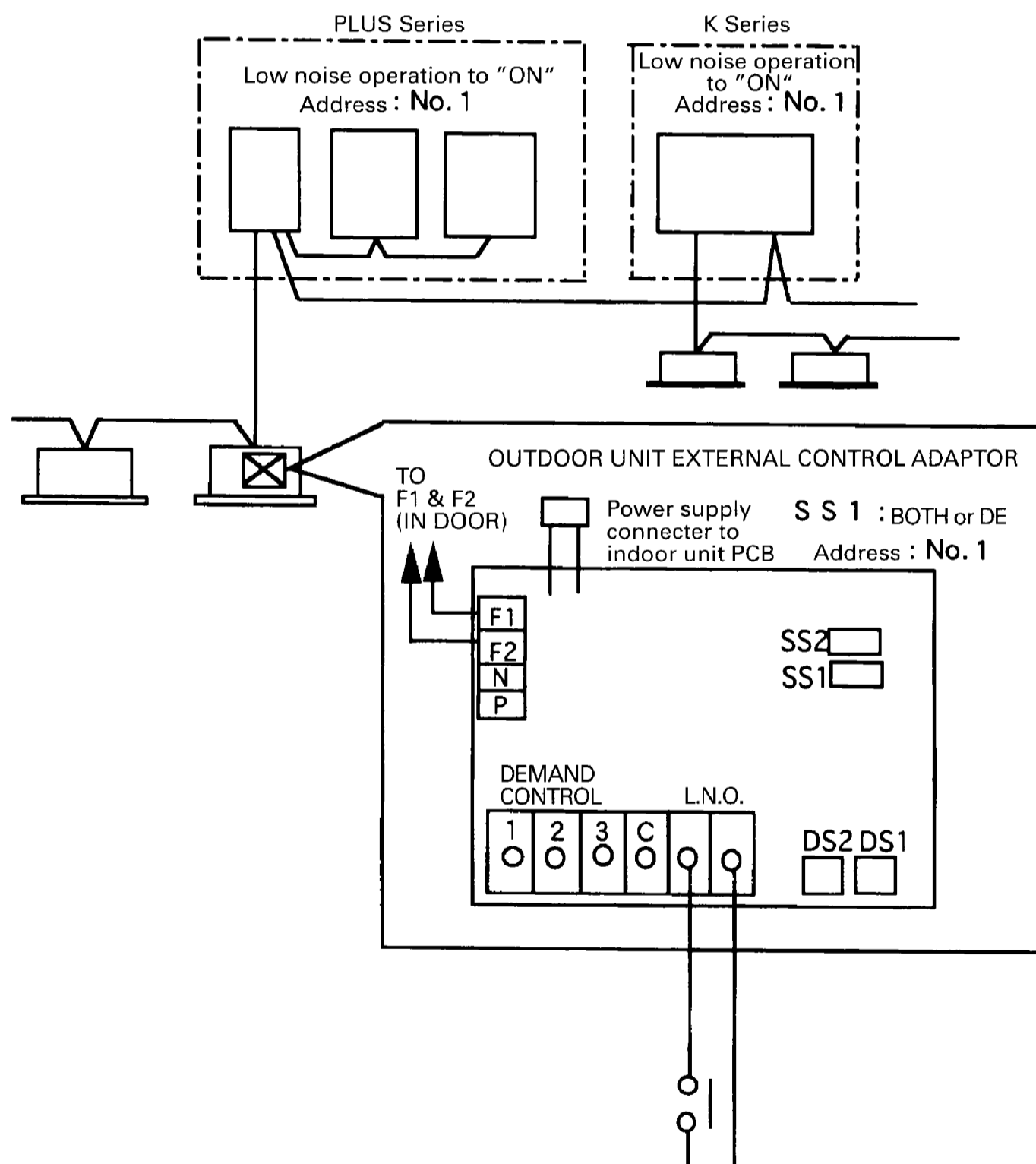

## 10. Demand Control

By connecting the external contact input to the low noise input of the outdoor unit external control adaptor for outdoor unit (optional), you can save power and lower operating noise by 2 -3 dB.

### 1. Outdoor unit field setting

- Setting mode 1: Set low noise operation to "ON."
- Setting mode 2: Match low noise operation and demand control address with address of outdoor unit external control adaptor.

### 2. Outdoor unit external control adaptor setting

- Function switch (SS1)  
Set to "BOTH" or "DE."
- Address setting switches (DS1, DS2)  
Match with outdoor unit low noise operation and demand control address.

[Low noise control system example]

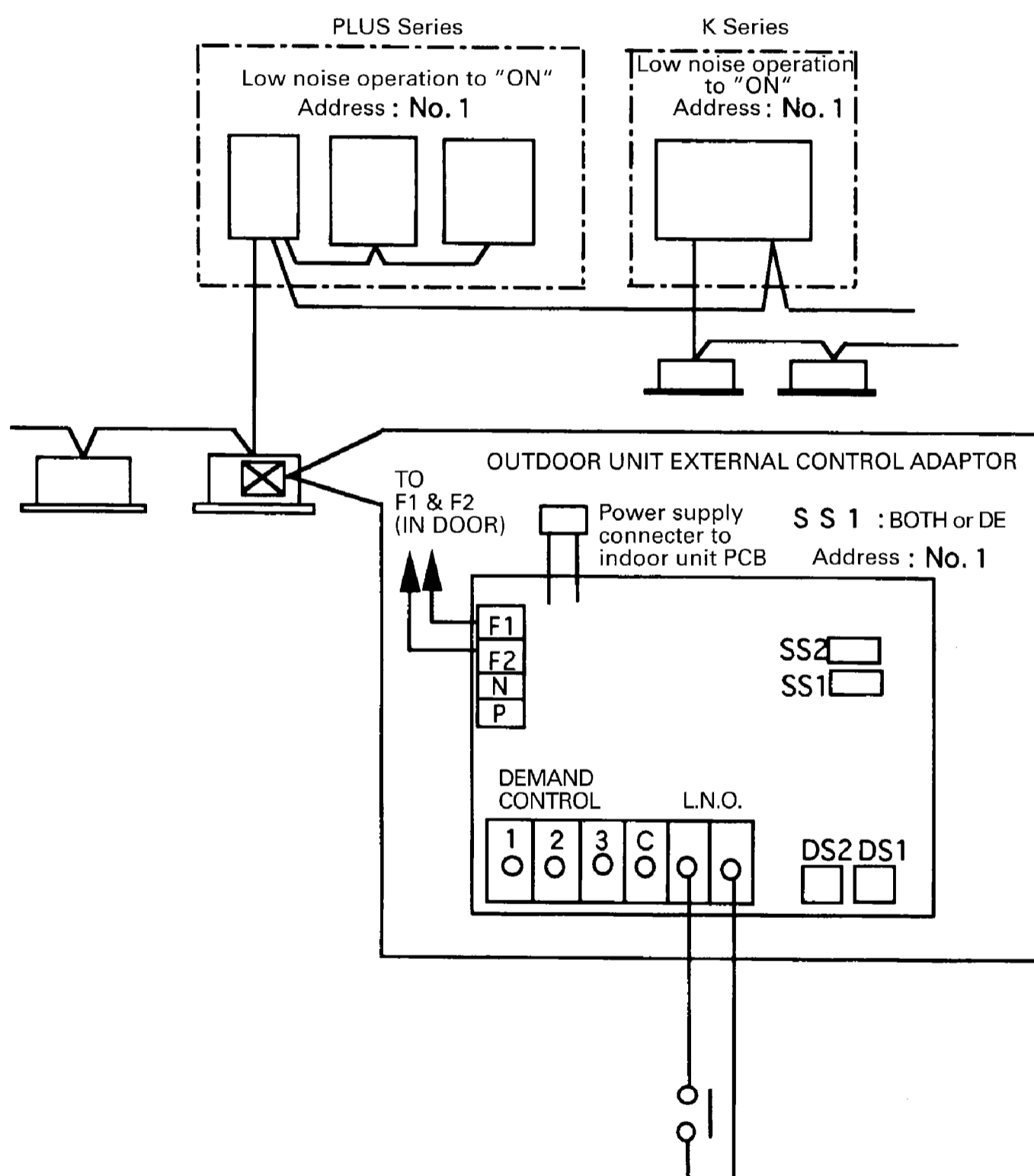

## 11. Wiring Check Operation

If within 12 hours of stopping cooling or heating, be sure to run all indoor units in the system you want to check in the fan mode for about 60 minutes in order to prevent mis-detection.

### Operation method

1. In the monitor mode, check the number of connected indoor units. (See monitor mode.)
2. Push and hold the WIRING CHECK button (BS4) for 5 seconds to perform wiring check operation.  
While running, TEST (H2P) lights and goes off when finished.  
If TEST (H2P) flickers (wiring check operation failure), push and hold the RESET button (BS5) for 5 seconds, and then repeat the procedure from the beginning.
3. About 1 minute after you finish running the system, once again check the number of connected indoor units in the monitor mode and make sure the number agrees with the first time you checked. If not, it indicates that there is a wiring mistake. Fix the wiring of the indoor unit whose remote controller displays "UF" when its ON/OFF switch is turned ON.

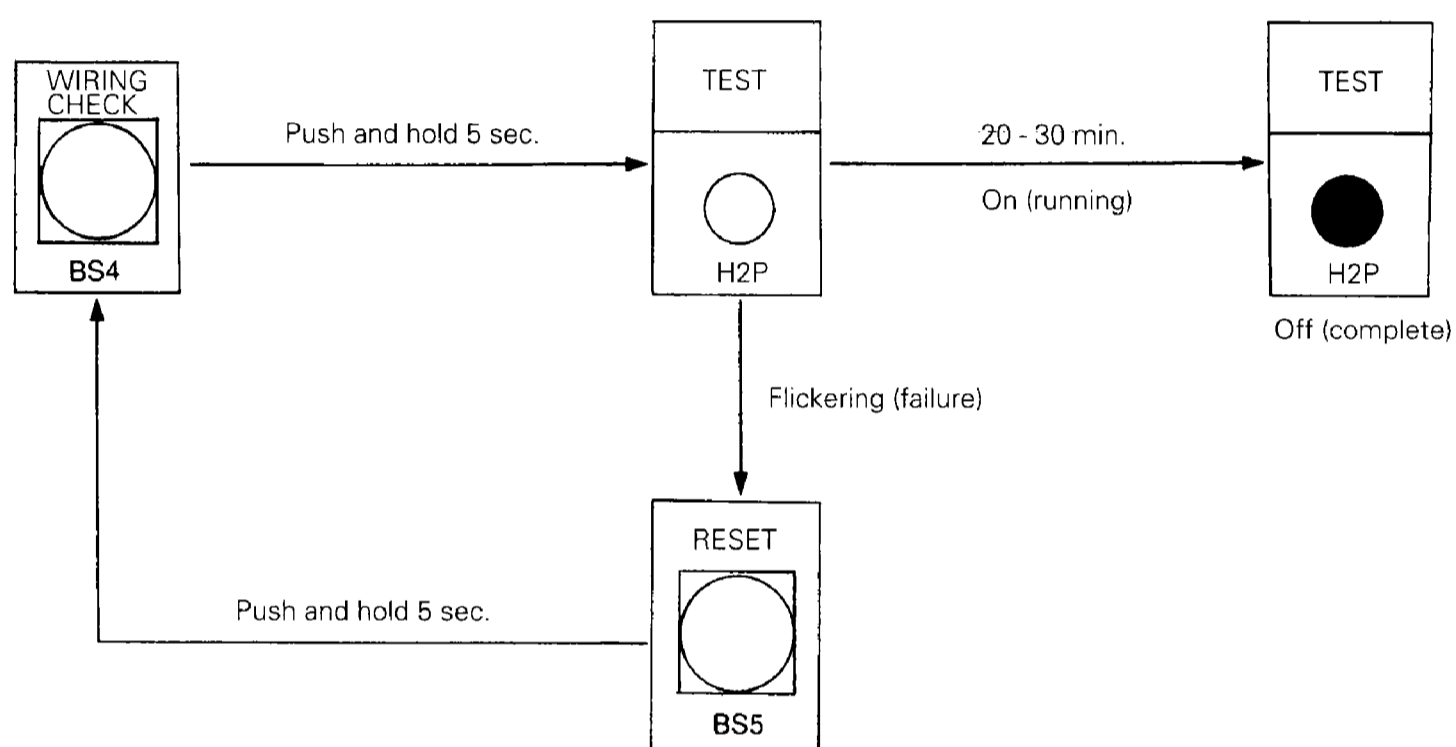

NOTE: Other settings are not accepted during wiring check operation.



# **TROUBLESHOOTING**

## **PLUS Series**

# 1. Troubleshooting for VRV PLUS Series

You can troubleshoot by the malfunction code displayed on the indoor unit's remote controller same as other series. The HWL lamp lights to let you know which of the outdoor units is malfunctioning. The function unit is not equipped with a HWL.

Example: If an "E0" malfunction is displayed on the remote controller and HWL is lit for constant speed type outdoor unit 1. This tells you that the malfunction was caused by a safety device of the constant speed type outdoor unit tripping.

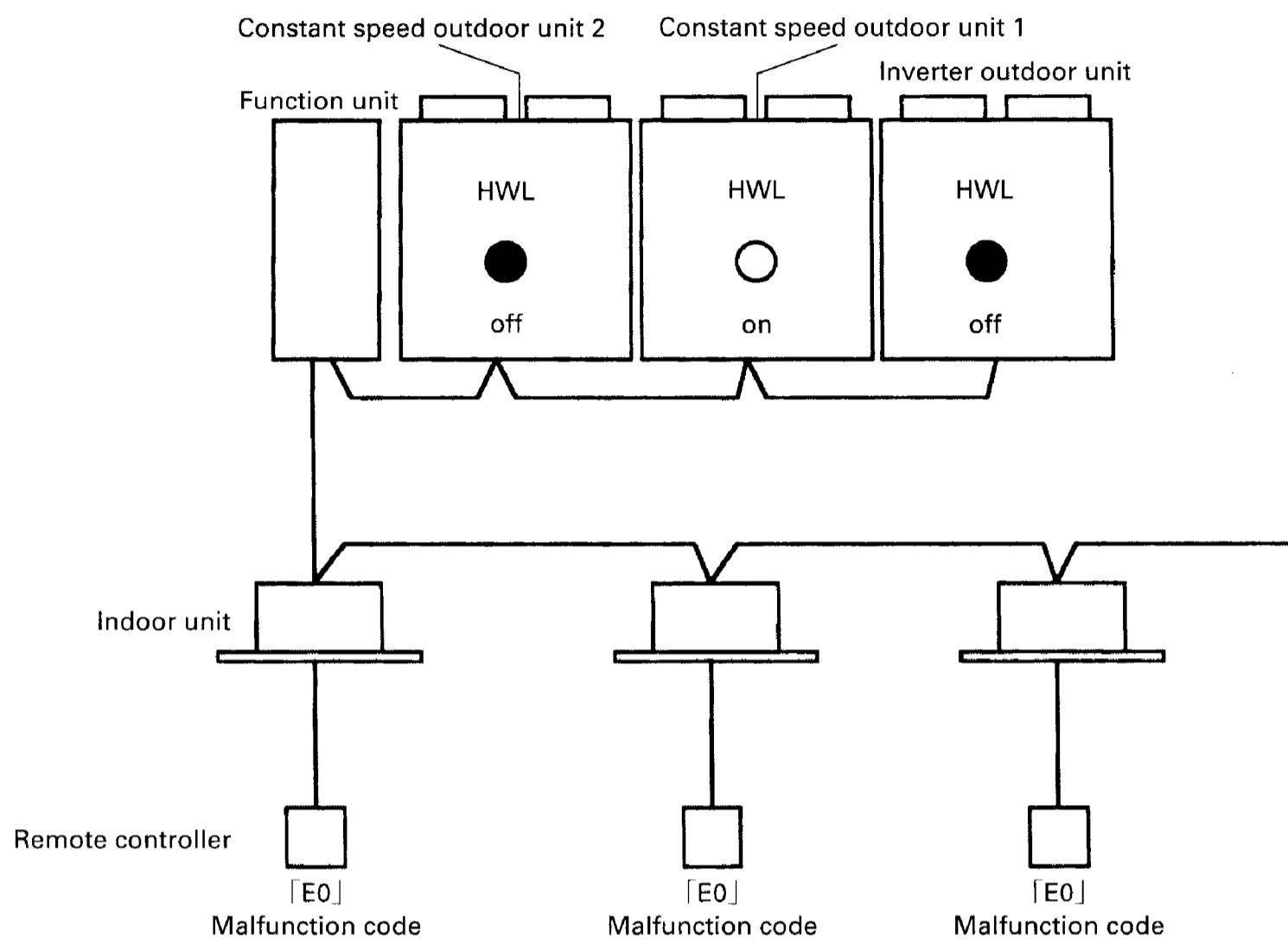

## 2. Diagnosis by Malfunction Code

Malfunction code	Malfunction contents	Fan operation	Page
E0	Outdoor unit: Actuation of safety device		248
E1	Outdoor unit: PC board defect		250
E3	Outdoor unit: Actuation of high pressure switch		250
E4	Outdoor unit: Actuation of low pressure switch	○	251
E9	Outdoor unit: Malfunction of moving part of electronic expansion valve (Y1E)	○	252
F3	Outdoor unit: Abnormal discharge pipe temperature	○	253
H3	Outdoor unit: Defect of pressure switch for high pressure control	○	254
H4	Outdoor unit: Defect of pressure switch for low pressure control	○	254
H9	Outdoor unit: Malfunction of thermistor for outdoor air (R1T)	○	255
J3	Outdoor unit: Malfunction of discharge pipe thermistor (R3T)	○	255
J5	Outdoor unit: Malfunction of thermistor (R4T) for suction pipe	○	256
J6	Outdoor unit: Malfunction of thermistor (R2T) for heat exchanger	○	256
J7	Outdoor unit: Malfunction of thermistor (R6T) for header	○	257
JA	Outdoor unit: Malfunction of discharge pipe pressure sensor	○	258
JC	Outdoor unit: Malfunction of suction pipe pressure sensor	○	259
JH	Outdoor unit: Malfunction of oil temperature thermistor (R5T)	○	260
U0	Low pressure drop due to refrigerant shortage or electronic expansion valve failure	○	261
U1	Negative phase, open phase	○	262
U4	Malfunction of transmission between indoor units	○	263
U7	Malfunction of transmission between outdoor units	○	264
UA	Excessive number of indoor units	○	265
UF	Refrigerant system not set, incompatible wiring/piping	○	266
UH	Malfunction of system, refrigerant system address undefined	○	267
L4	Actuation of fin thermal	○	270
L5	Defect of compressor coil	○	271
L8	Compressor overload	○	272
L9	Defect of compressor	○	273
LC	Malfunction of connection between the inverter unit and outdoor unit PC board	○	274
U2	Power supply insufficient	○	275
P1	Open phase	○	276
P4	Defect of radiator fin temperature sensor	○	277

### 3. Troubleshooting

#### Remote controller display

#### Malfunction code "EO" blinks.

#### Cause of malfunction

- (1) Tripped outdoor unit safety device (INV outdoor unit / Constant speed outdoor unit)
- (2) Faulty outdoor unit PC board (INV outdoor unit / Constant speed outdoor unit)
- (3) Instantaneous power failure

#### A. Inverter type unit's HWL is lit.

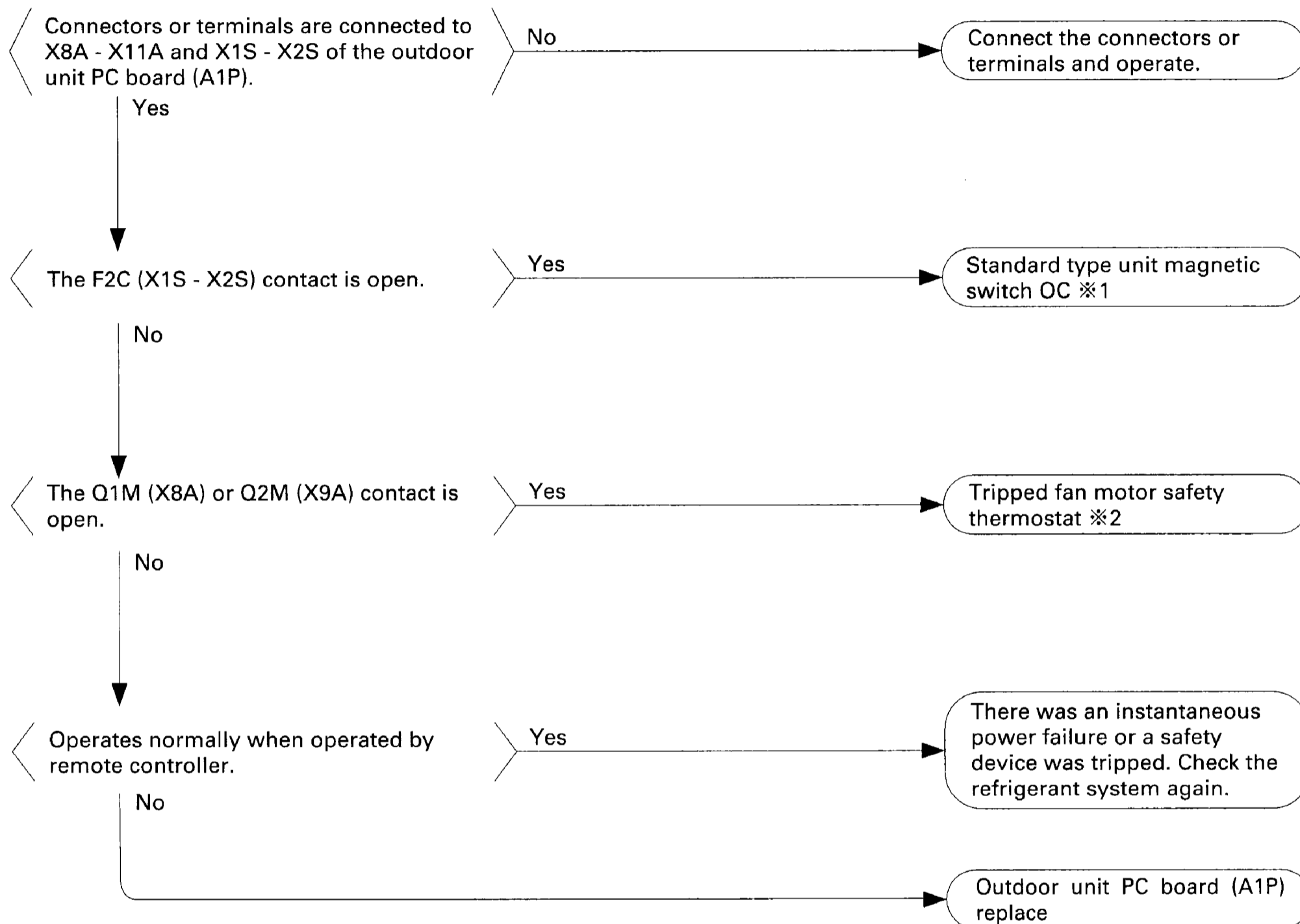

#### ※1: Magnetic switch OC

- Faulty compressor
- Power supply voltage malfunction
- Faulty magnetic switch
- Other

#### ※2: Tripped fan motor safety thermostat

- Faulty fan motor
- Faulty condenser
- Other

## B. HWL of Constant speed outdoor unit is lit

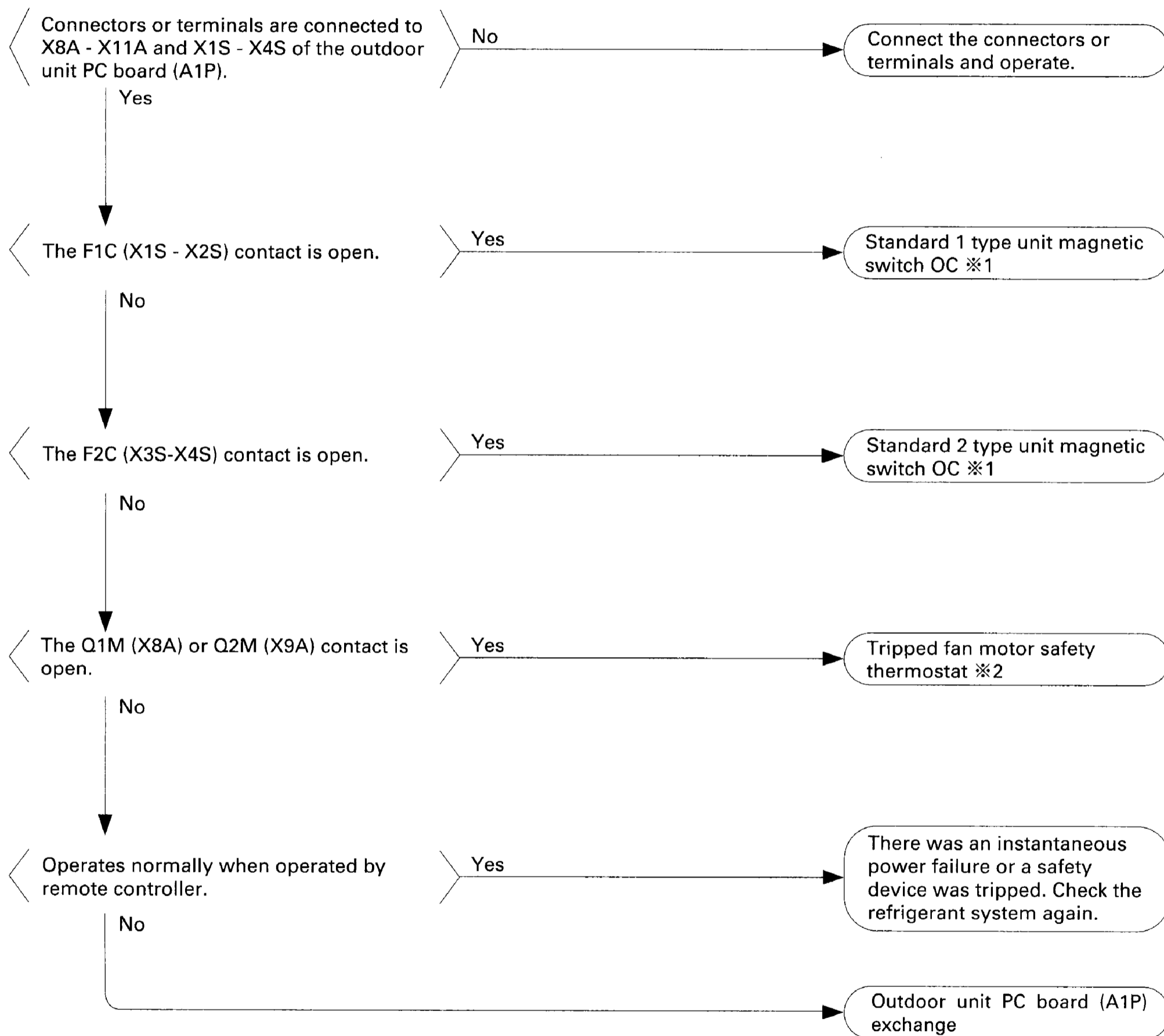

### ※1: Magnetic switch OC

- Faulty compressor
- Power supply voltage malfunction
- Faulty magnetic switch
- Other

### ※2: Tripped fan motor safety thermostat

- Faulty fan motor
- Faulty condenser
- Other

## Remote controller display

### Malfunction code "E1" blinks.

#### Cause of malfunction

Faulty outdoor unit PC board (FUNCTION UNIT, INVERTER OUTDOOR UNIT, CONSTANT SPEED OUTDOOR UNIT)

A. Change the outdoor unit PC board of the inverter type or constant speed type outdoor unit for which the HWL is lit.

B. If the HWL for the inverter type or constant speed type outdoor unit is not lit, change the function unit's PC board. (The function unit is not equipped with a HWL.)

## Remote controller display

### Malfunction code "E3" blinks.

#### Cause of malfunction

(1) Actuation of outdoor unit high pressure switch

(2) Defect of outdoor unit PC board

(3) Instantaneous power failure

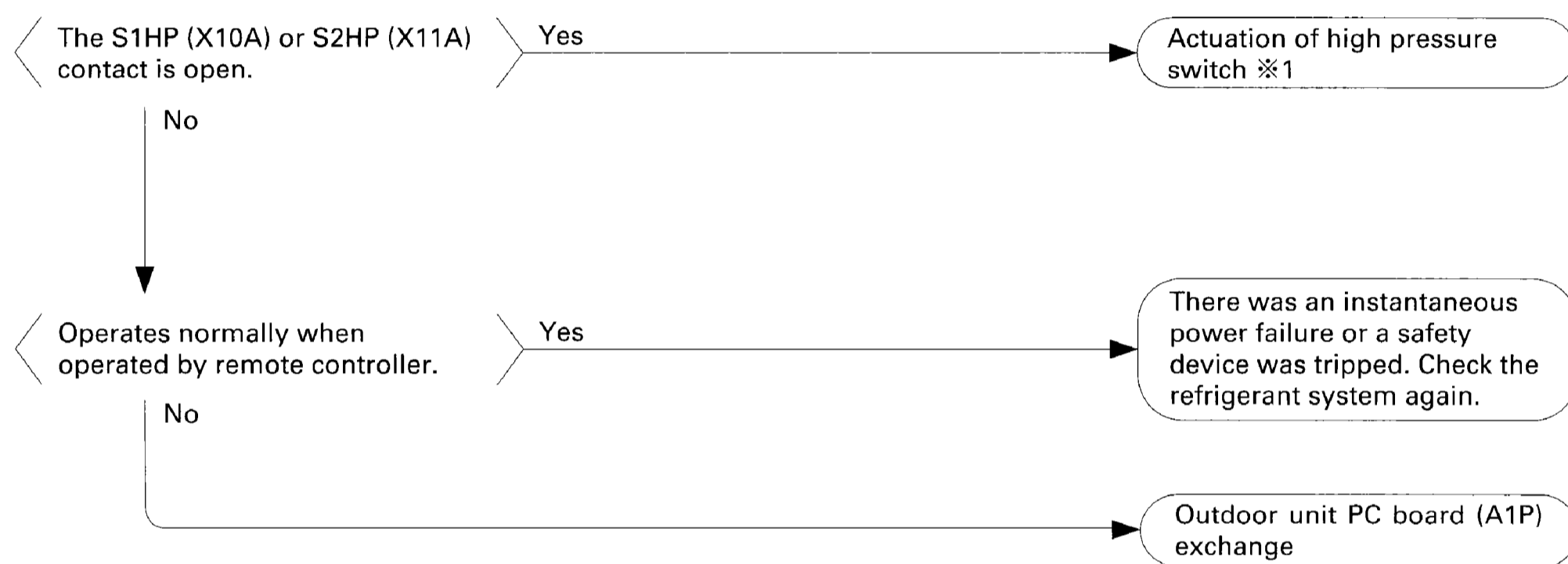

※1: Actuation of high pressure switch (HPS)

The outdoor unit PC board's connector is disconnected.

Is the outdoor unit heat exchanger dirty?

Defect of outdoor fan

Is the refrigerant over-filled?

## Remote controller display

### Malfunction code "E4" blinks.

#### Cause of malfunction

- (1) Abnormal drop of low pressure (0 kg/cm<sup>2</sup> [0 MPa])
- (2) Defect of low pressure sensor
- (3) Defect of outdoor unit PC board

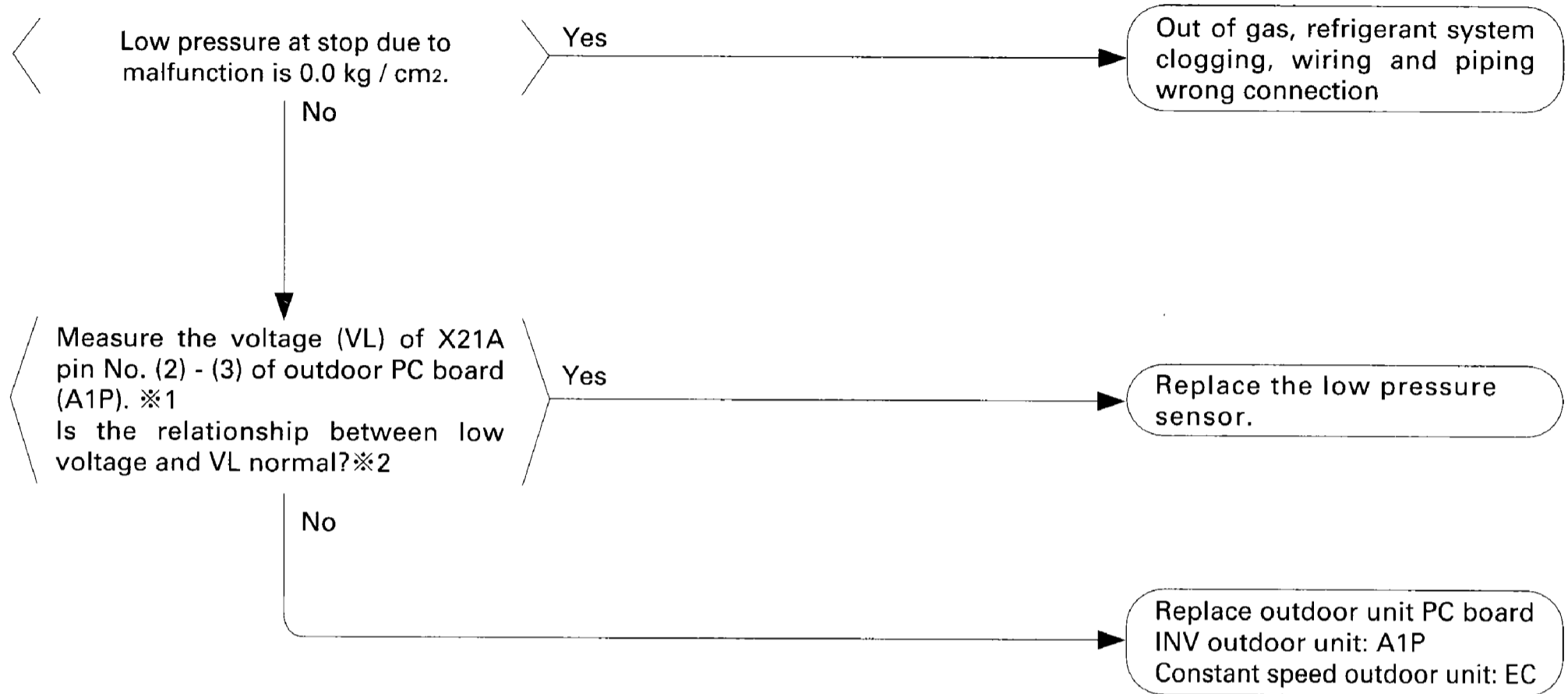

\*1: Voltage measurement point

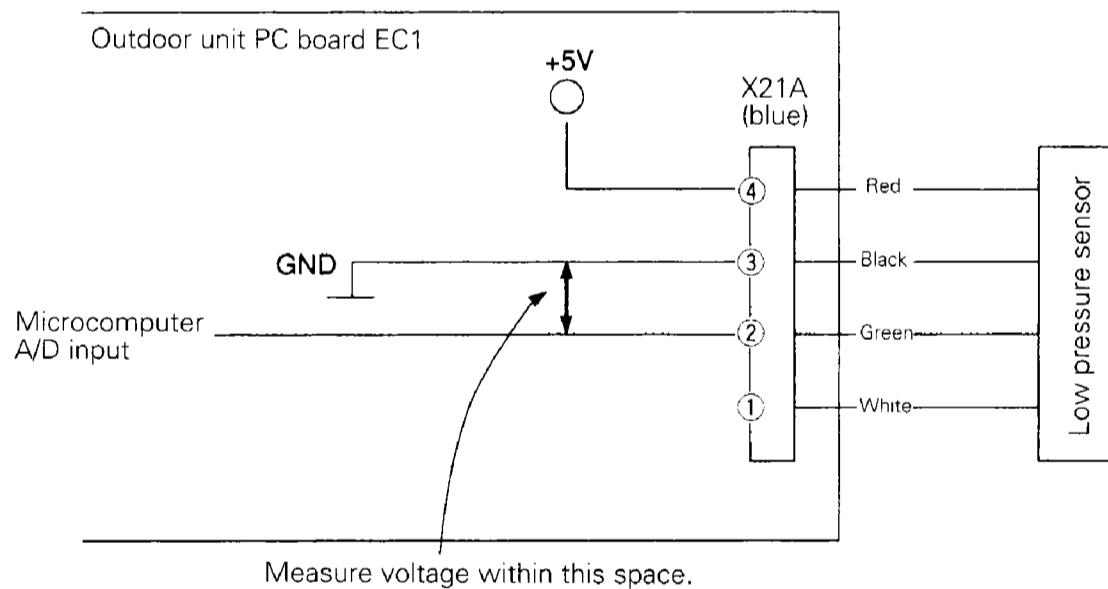

\*2: Refer to the pressure sensor, pressure - voltage characteristics table on P321.

## Remote controller display

### Malfunction code "E9" blinks.

#### Cause of malfunction

- (1) Defect of moving part of electronic expansion valve
- (2) Defect of outdoor unit PC board (A1P)
- (3) Defect of connecting cable

Troubleshooting the outdoor unit for which the HWL is lit in accordance with the following flow chart.

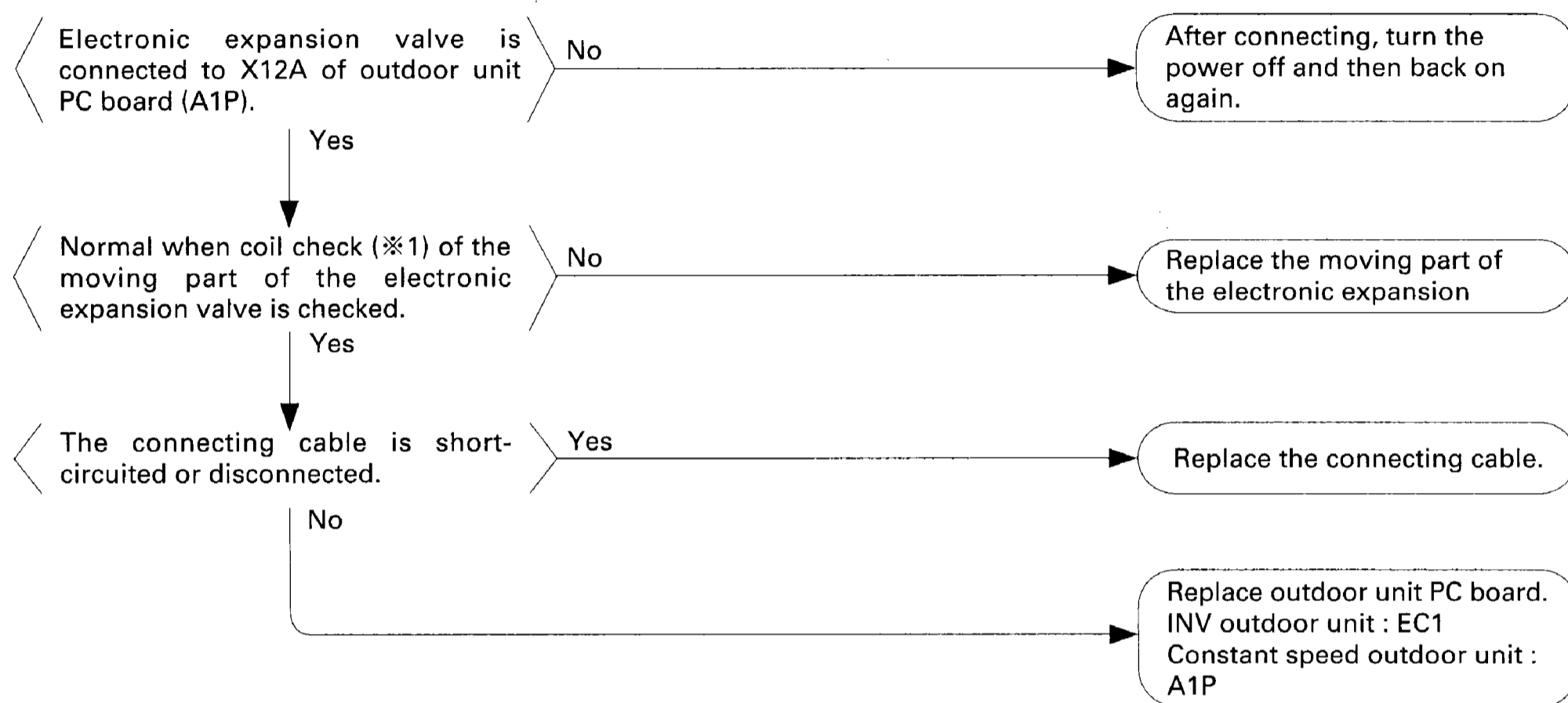

※1 Coil check method for the moving part of the electronic expansion valve

Disconnect the electronic expansion valve from the PC board and check the continuity between the connector pins.

(Normal)

Pin No.	①White	②Yellow	③Orange	④Blue	⑤Red	⑥Brown
①White		×	⊙	×	○	×
②Yellow			×	⊙	×	○
③Orange				×	○	×
④Blue					×	○
⑤Red						×
⑥Brown						

⊙: Continuity  
Approx. 300Ω  
○: Continuity  
Approx. 150Ω  
×: No continuity



## Remote controller display

### Malfunction code "F3" blinks.

#### Cause of malfunction

- (1) Abnormal discharge pipe temperature
- (2) Defect of discharge pipe thermistor (5K: R3T 8K, 10K: R3-1T, R3-2T)
- (3) Defect of outdoor unit PC board
- (4) Discharge pipe thermistor wrong connection
- (5) Liquid injection solenoid valve wrong connection

Troubleshooting the outdoor unit for which HWL is lit in accordance with the following flow chart.

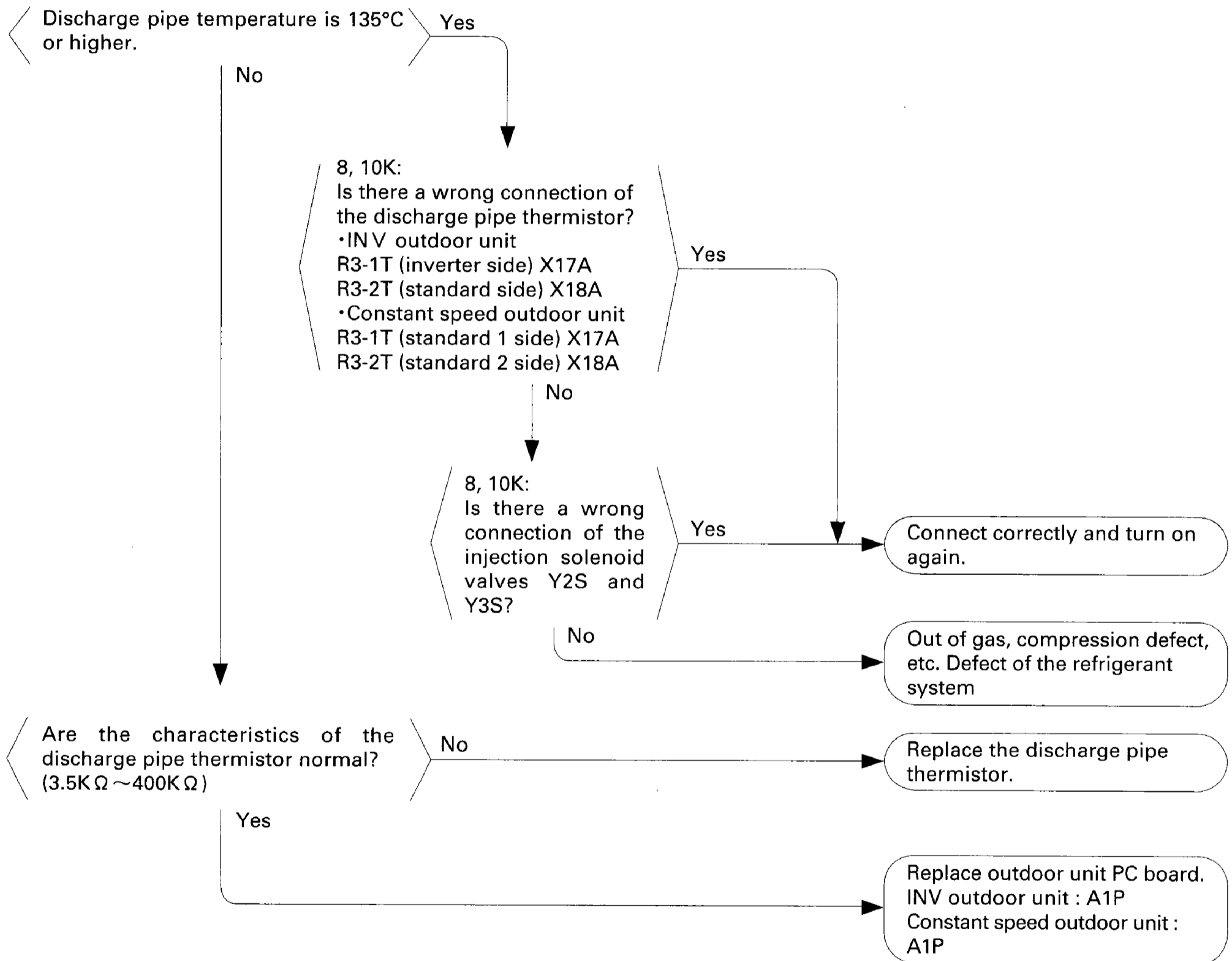

## Remote controller display

### Malfunction code "H3" blinks.

#### Cause of malfunction

- (1) Defect of pressure switch for high pressure control
- (2) Defect of outdoor unit PC board
- (3) Disconnected or faulty wiring connector

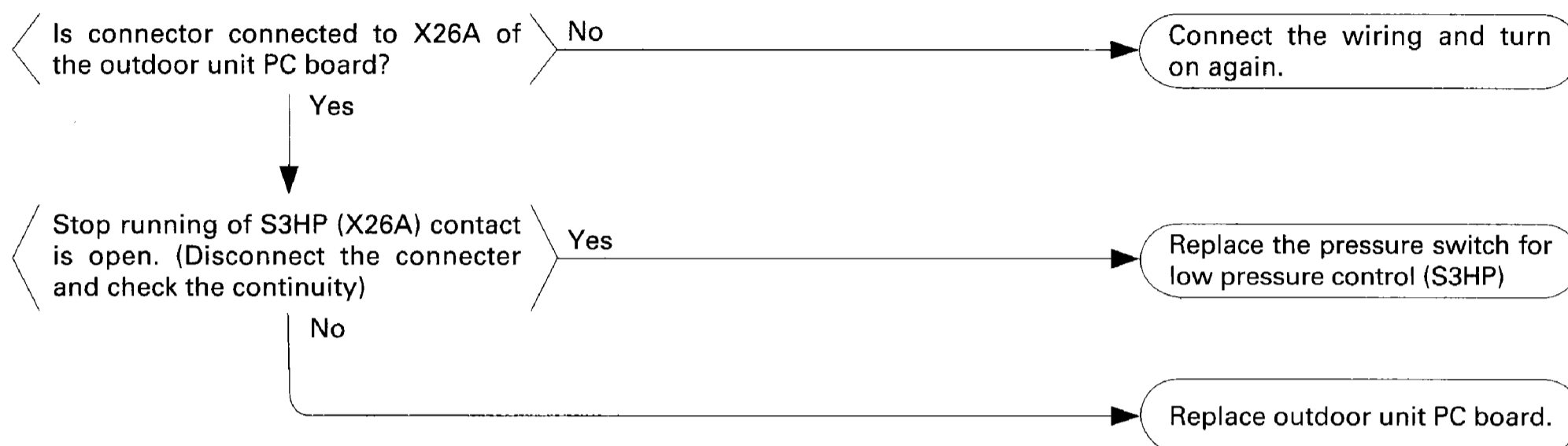

## Remote controller display

### Malfunction code "H4" blinks.

#### Cause of malfunction

- (1) Defect of pressure switch for low pressure control
- (2) Defect of outdoor unit PC board
- (3) Disconnected or faulty wiring connector

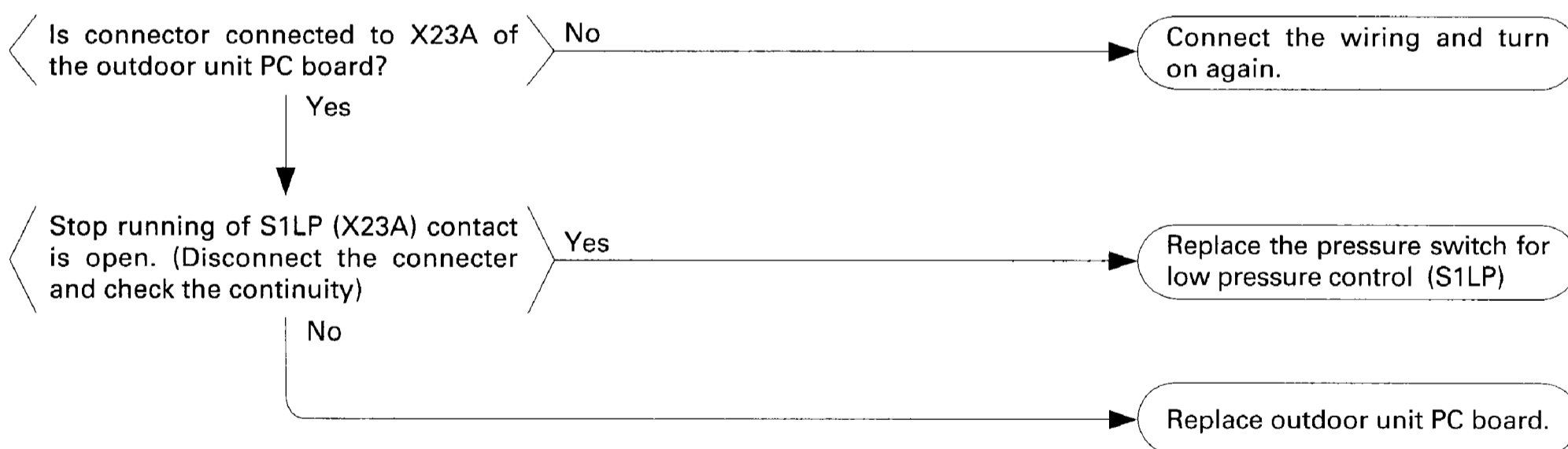

## Remote controller display

### Malfunction code "H9" blinks.

#### Cause of malfunction

- (1) Defect of thermistor (R1T) for outdoor unit outdoor air intake
- (2) Defect of outdoor unit PC board

Troubleshoot the outdoor unit for which the HWL is lit in accordance with the following flow chart.

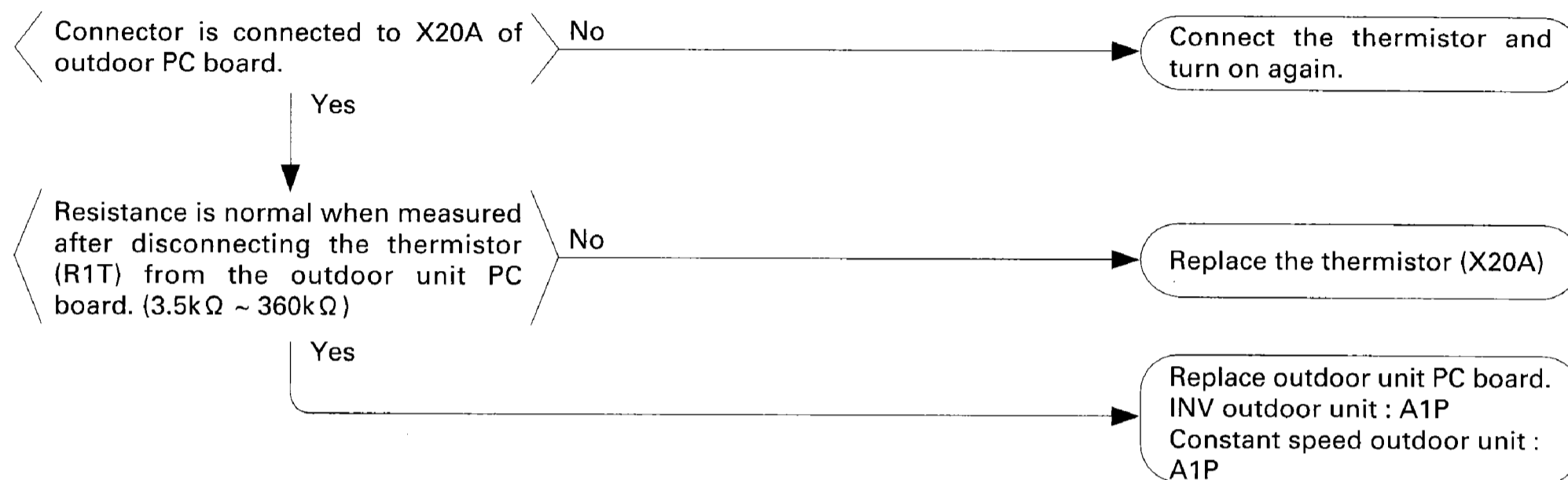

The alarm indicator is displayed when the fan is being used also.

## Remote controller display

### Malfunction code "J3" blinks.

#### Cause of malfunction

- (1) Defect of thermistor (R3T, R3-1T, R3-2T) for outdoor unit discharge pipe
- (2) Defect of outdoor unit PC board

Troubleshoot the outdoor unit for which the HWL is lit in accordance with the following flow chart.

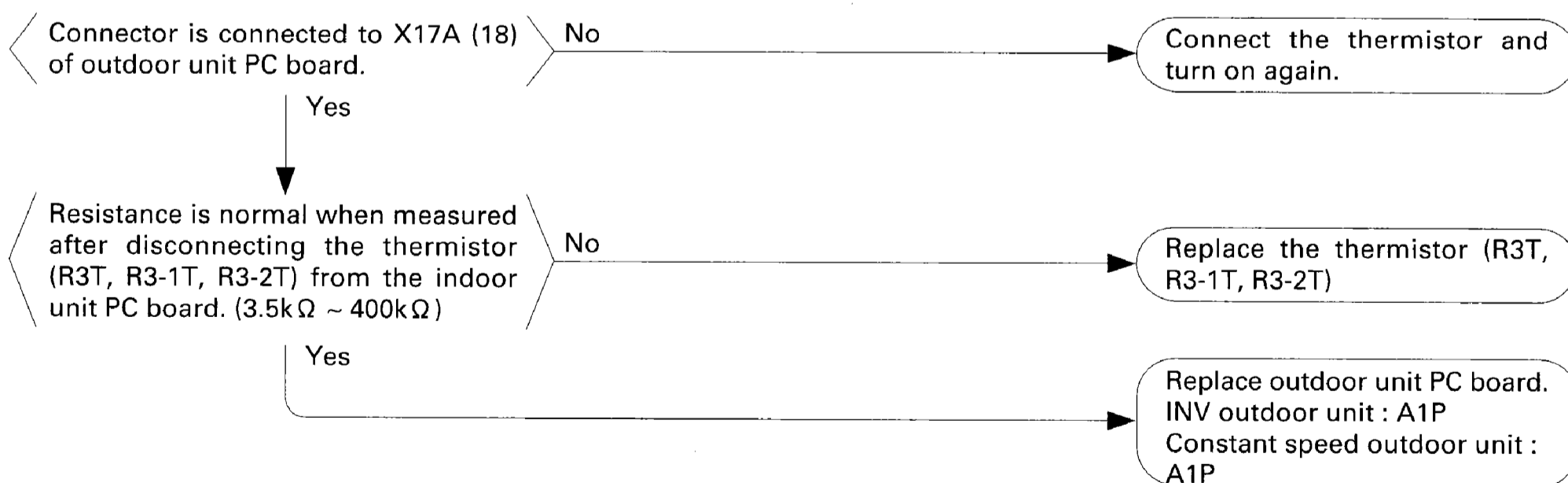

The alarm indicator is displayed when the fan is being used also.

## Remote controller display

### Malfunction code "J5" blinks.

#### Cause of malfunction

(1) Defect of thermistor (R4T) for outdoor unit suction pipe

(2) Defect of outdoor unit PC board

Troubleshoot the outdoor unit for which the HWL is lit in accordance with the following flow chart.

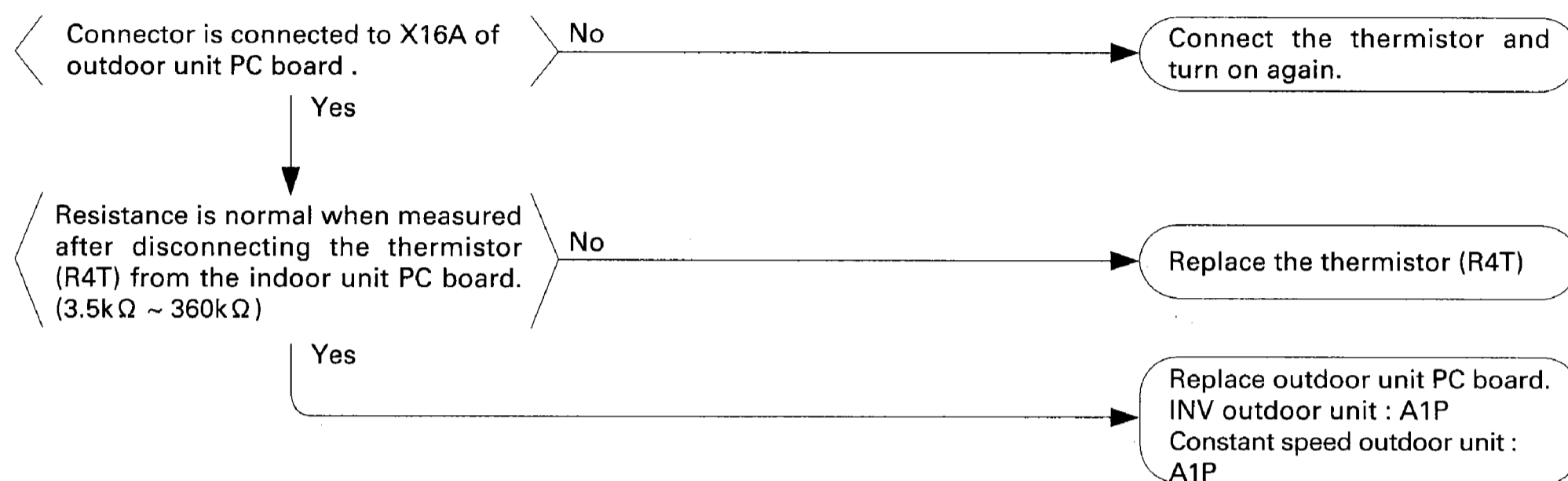

The alarm indicator is displayed when the fan is being used also.

## Remote controller display

### Malfunction code "J6" blinks.

#### Cause of malfunction

(1) Defect of thermistor (R2T) for outdoor unit coil

(2) Defect of outdoor unit PC board

Troubleshoot the outdoor unit for which the HWL is lit in accordance with the following flow chart.

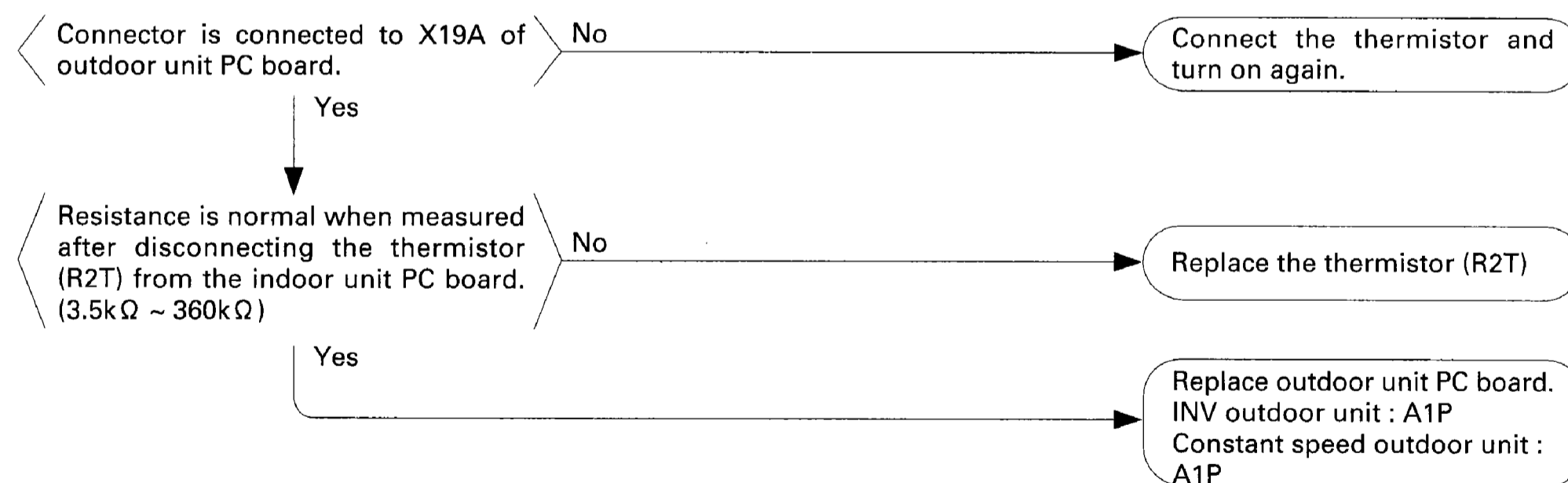

The alarm indicator is displayed when the fan is being used also.

## Remote controller display

### Malfunction code "J7" blinks.

#### Cause of malfunction

(1) Defect of thermistor (R6T) for outdoor unit header

(2) Defect of outdoor unit PC board

Troubleshoot the outdoor unit for which the HWL is lit in accordance with the following flow chart.

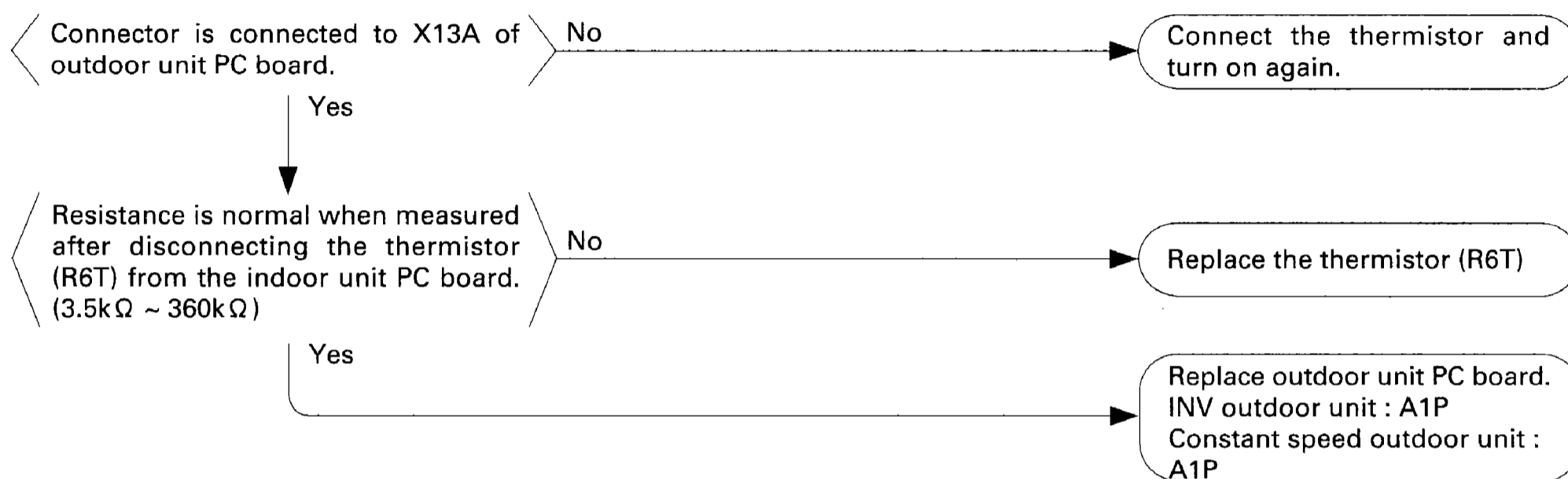

The alarm indicator is displayed when the fan is being used also.

## Remote controller display

### Malfunction code "JA" blinks.

#### Cause of malfunction

- (1) Defect of high pressure sensor system
- (2) Connection of low pressure sensor with wrong connection.
- (3) Defect of outdoor unit PC board.

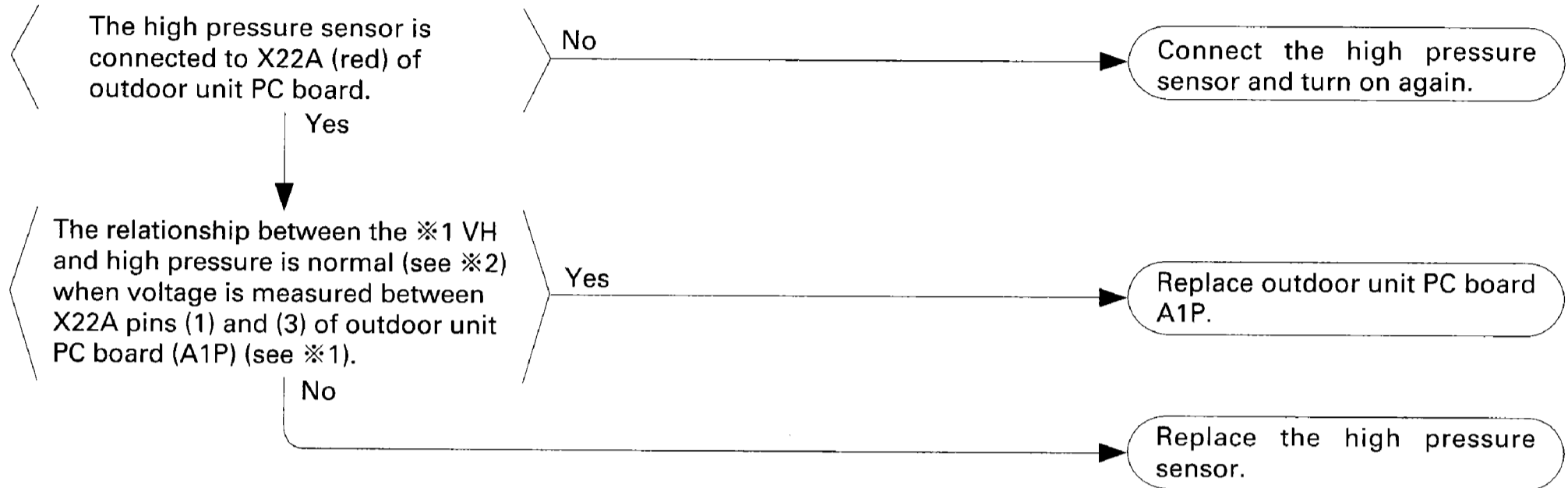

※1: Voltage measurement point

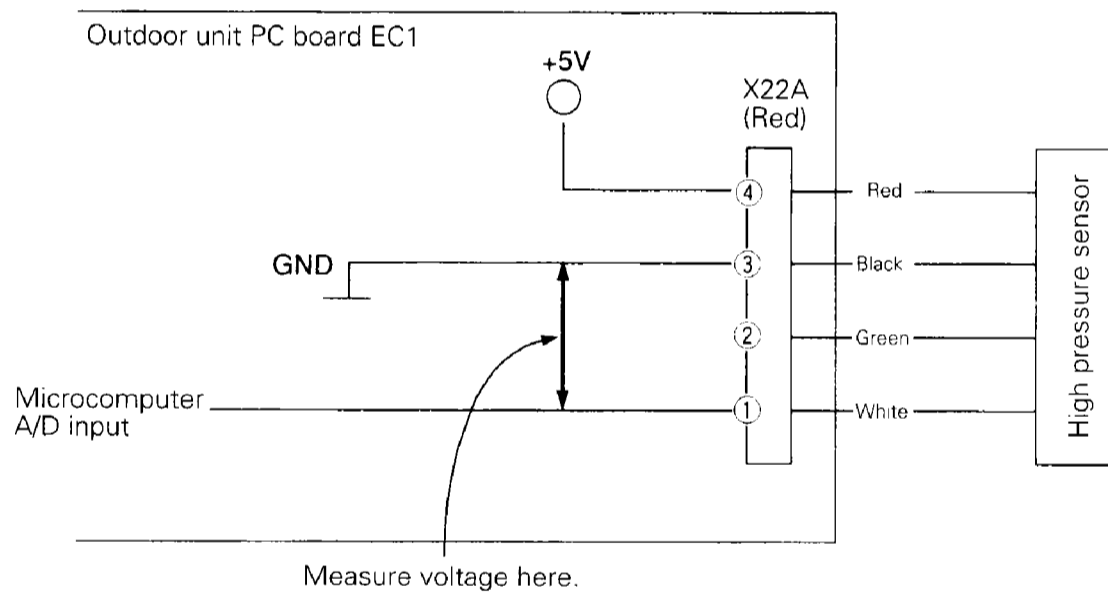

※2: Refer to pressure sensor, pressure / voltage characteristics table, P321.

## Remote controller display

### Malfunction code "JC" blinks.

#### Cause of malfunction

- (1) Defect of low pressure sensor system
- (2) Connection of high pressure sensor with wrong connection.
- (3) Defect of outdoor unit PC board.

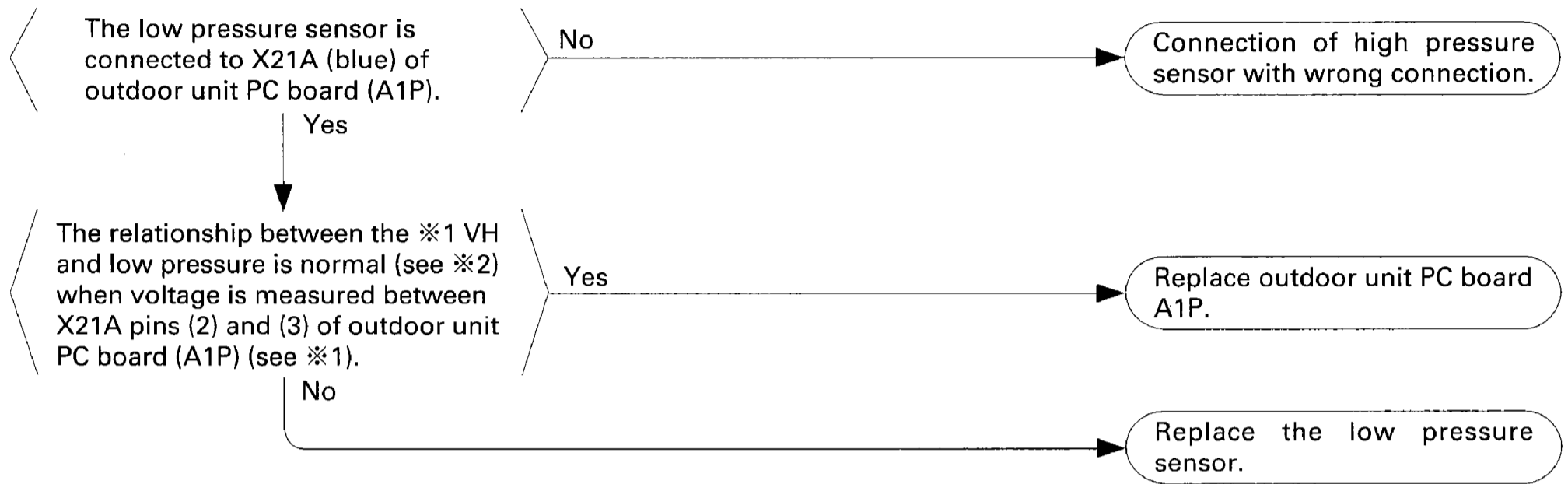

※1: Voltage measurement point

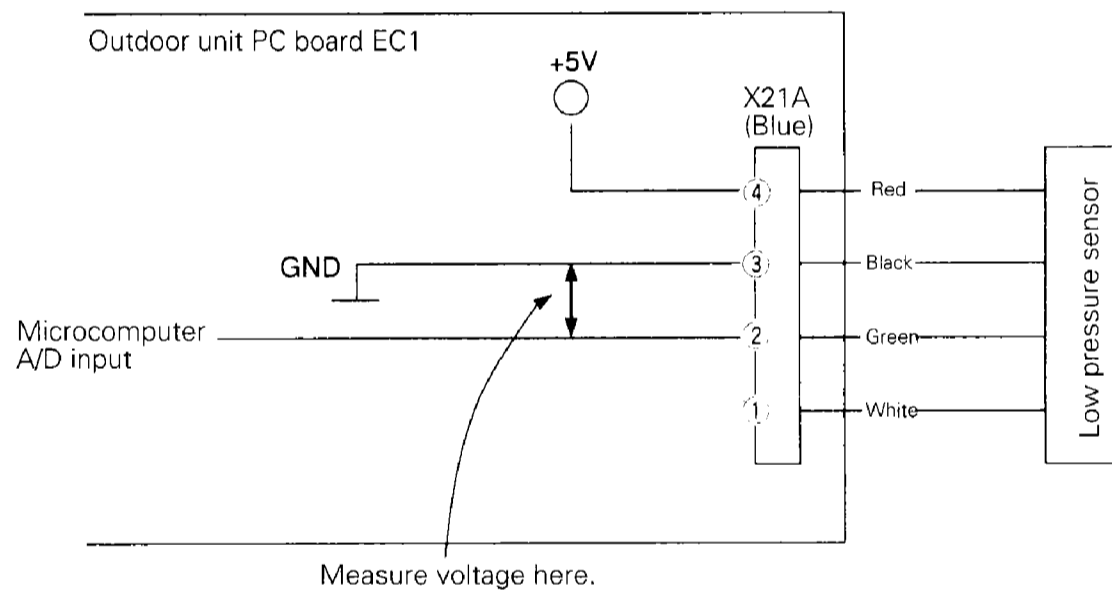

※2: Refer to pressure sensor, pressure/voltage characteristics table, P321.

## Remote controller display

### Malfunction code "JH" blinks.

#### Cause of malfunction

(1) Defect of oil temperature thermistor (R5T)

(2) Defect of outdoor unit PC board (A1P)

Troubleshoot the outdoor unit for which the HWL is lit in accordance with the following flow chart.

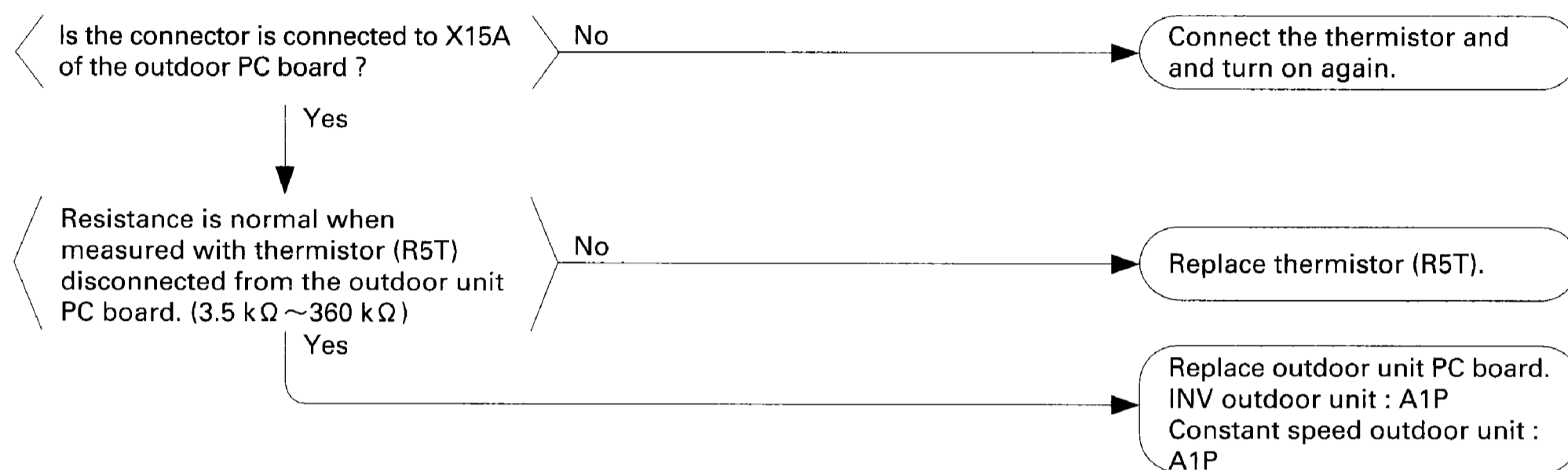



## Remote controller display

### Malfunction code "U0" blinks.

#### Cause of malfunction

- (1) Out of gas or refrigerant system clogging (incorrect piping)
- (2) Defect of thermistor (R2T, R4T) of INV outdoor unit
- (3) Defect of low pressure sensor of INV outdoor unit
- (4) Defect of outdoor unit PC board of INV outdoor unit

Troubleshoot the outdoor unit for which the HWL is lit in accordance with the following flow chart.

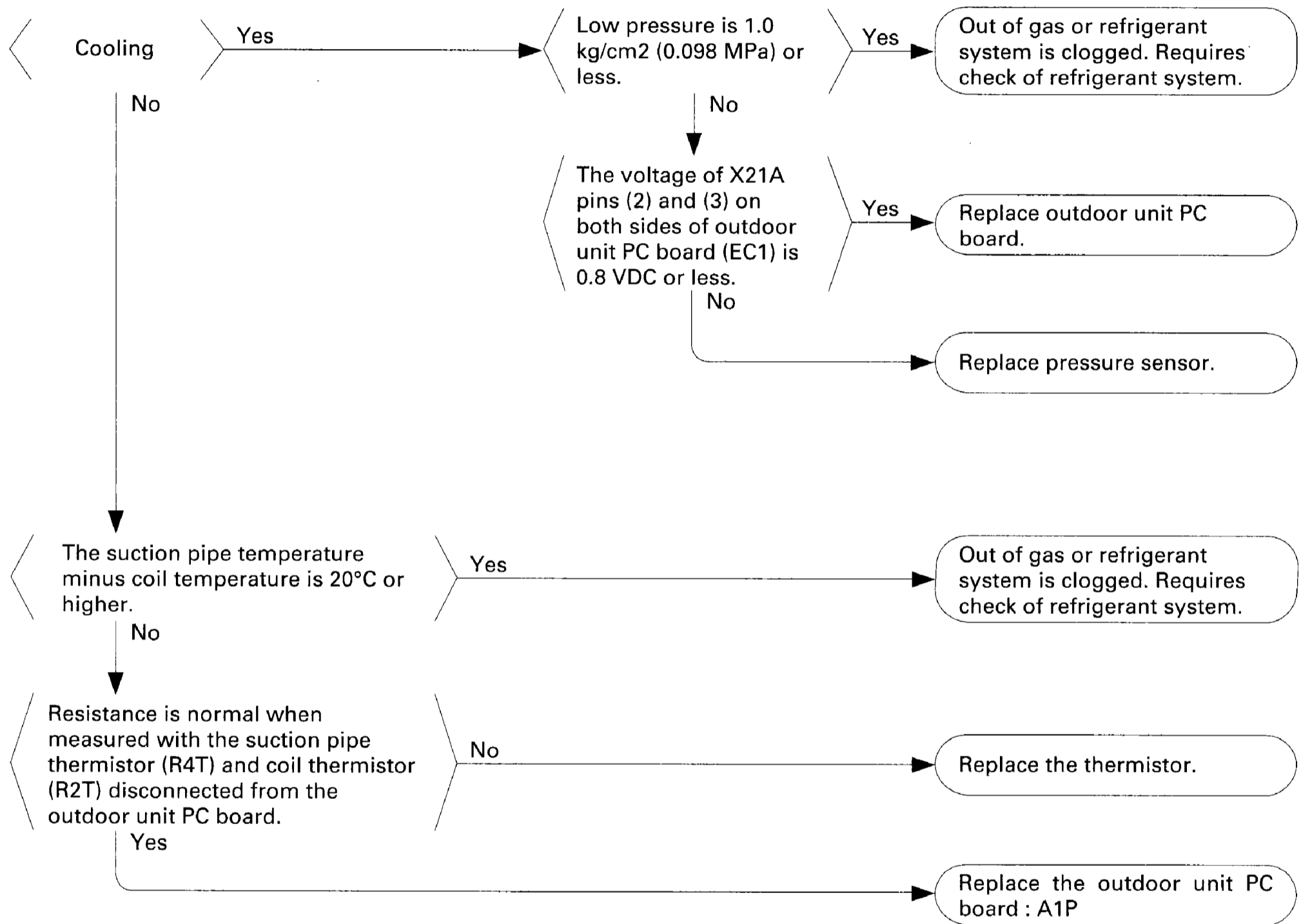

## Remote controller display

### Malfunction code "U1" blinks.

#### Cause of malfunction

(1) Power supply negative phase

(2) Power supply open phase

(3) Defect of outdoor PC board A1P

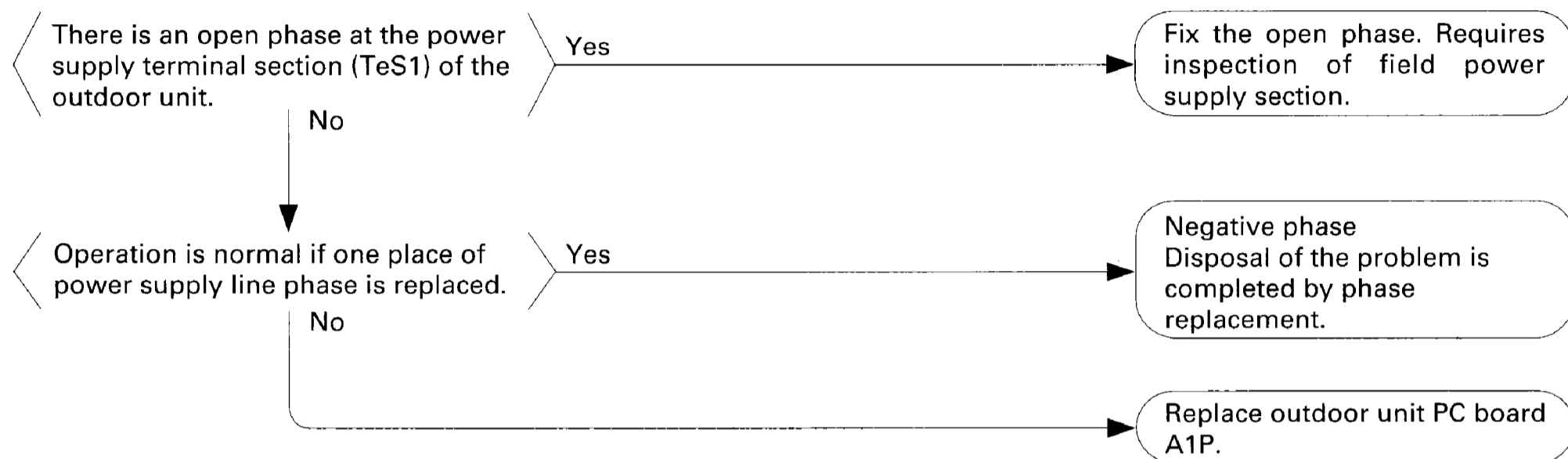

## Remote controller display

### Malfunction code "U4" blinks.

#### Cause of malfunction

- (1) Short circuited indoor or outdoor unit transmission wiring (F1, F2) or wiring mistake
- (2) Function unit power supply OFF
- (3) Incorrect system address
- (4) Faulty function unit PC board
- (5) Faulty indoor unit PC board

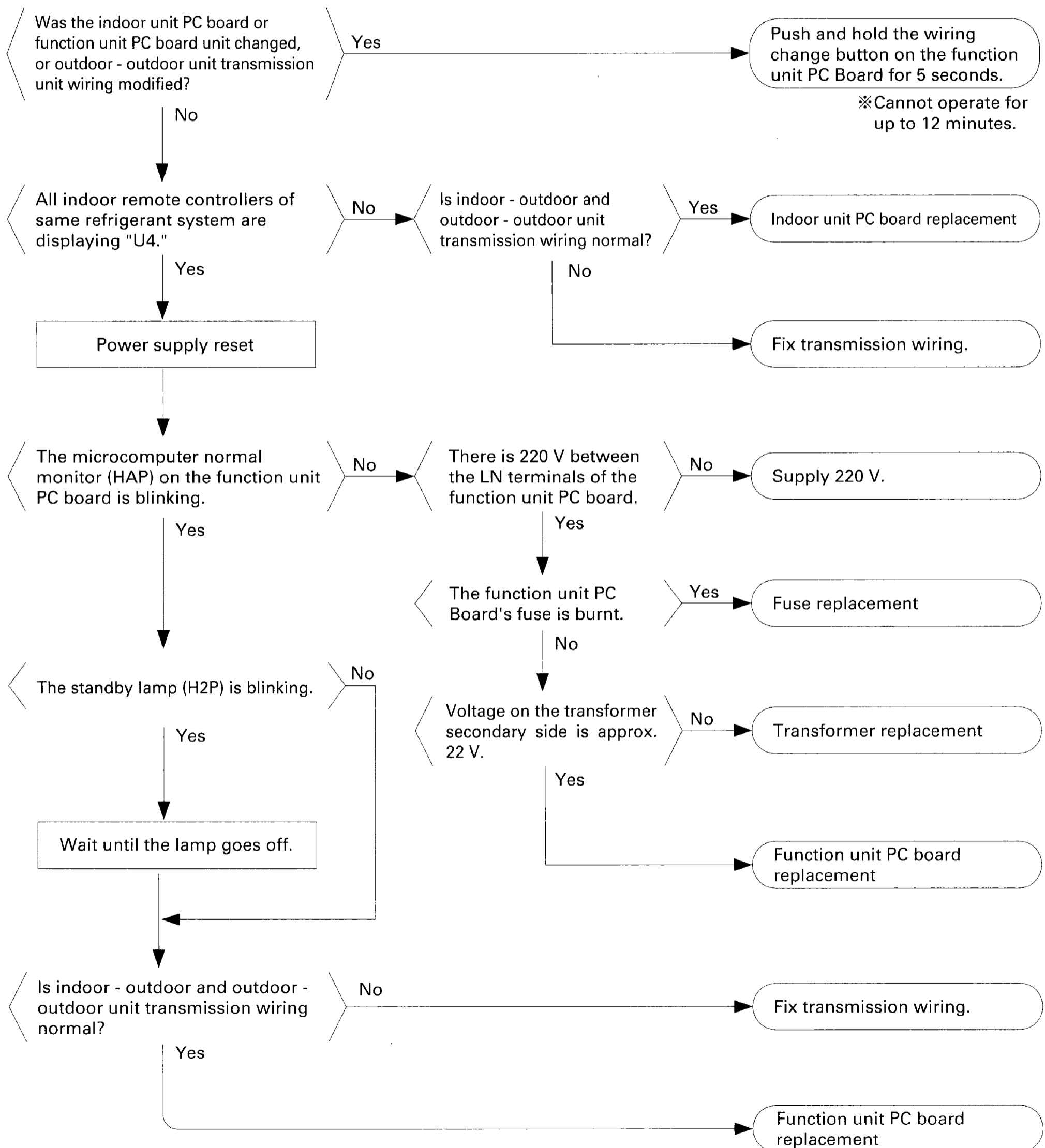

## Remote controller display

### Malfunction code "U7" blinks.

#### Cause of malfunction

- (1) Incorrect outdoor unit No. setting for constant speed type outdoor unit
- (2) Incorrect outdoor - outdoor unit transmission wiring connection (Q1Q2)
- (3) Incorrect function unit - outdoor unit external control adaptor transmission wiring connection
- (4) Incorrect C/H setting
- (5) Incorrect C/H unified address setting (function unit, outdoor unit external control adaptor)
- (6) Faulty function unit PC board
- (7) Faulty outdoor unit external control adaptor

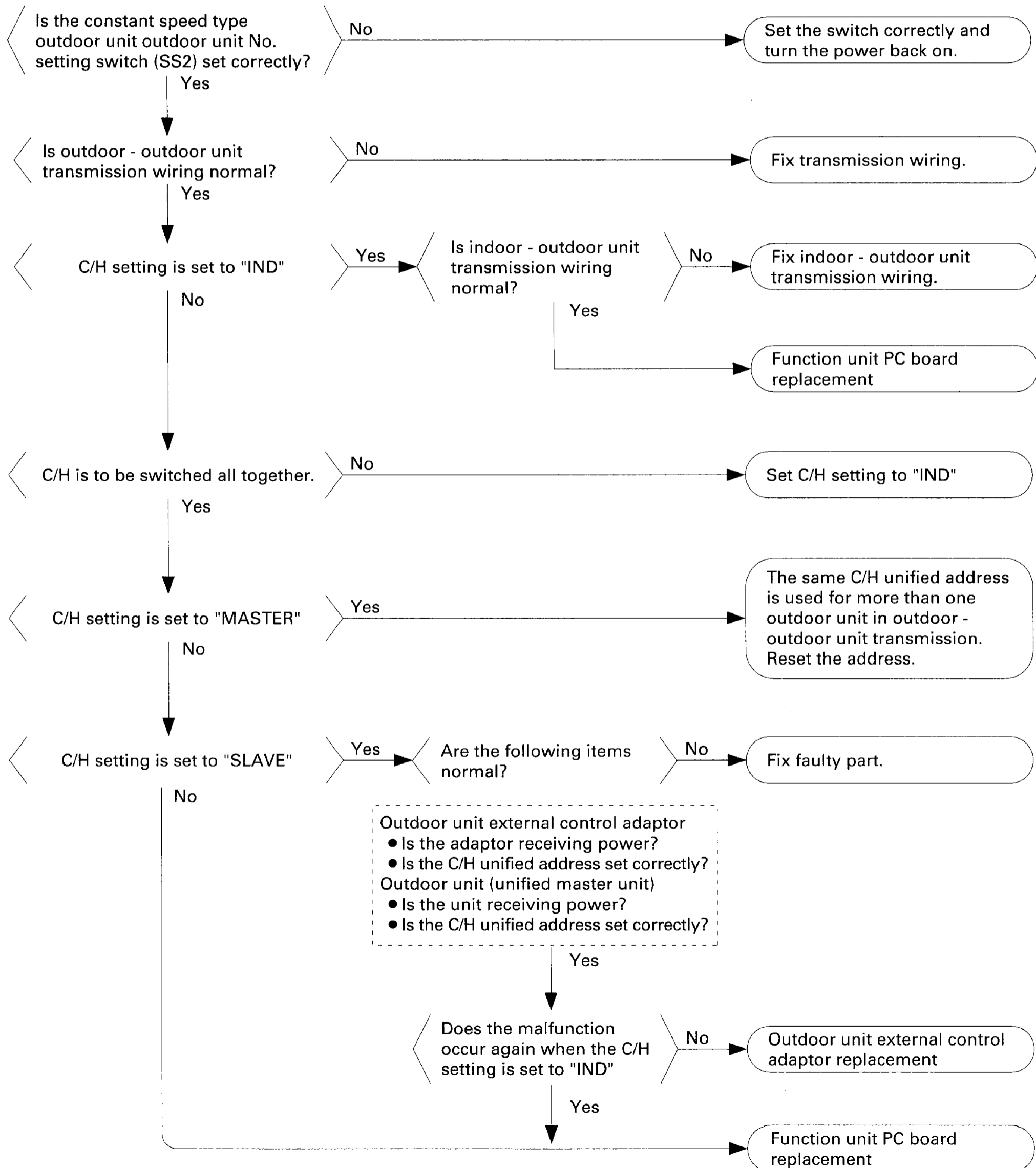

## Remote controller display

### Malfunction code "UA" blinks.

#### Cause of malfunction

- (1) The number of connectable indoor units has been exceeded.
- (2) Function unit PC board

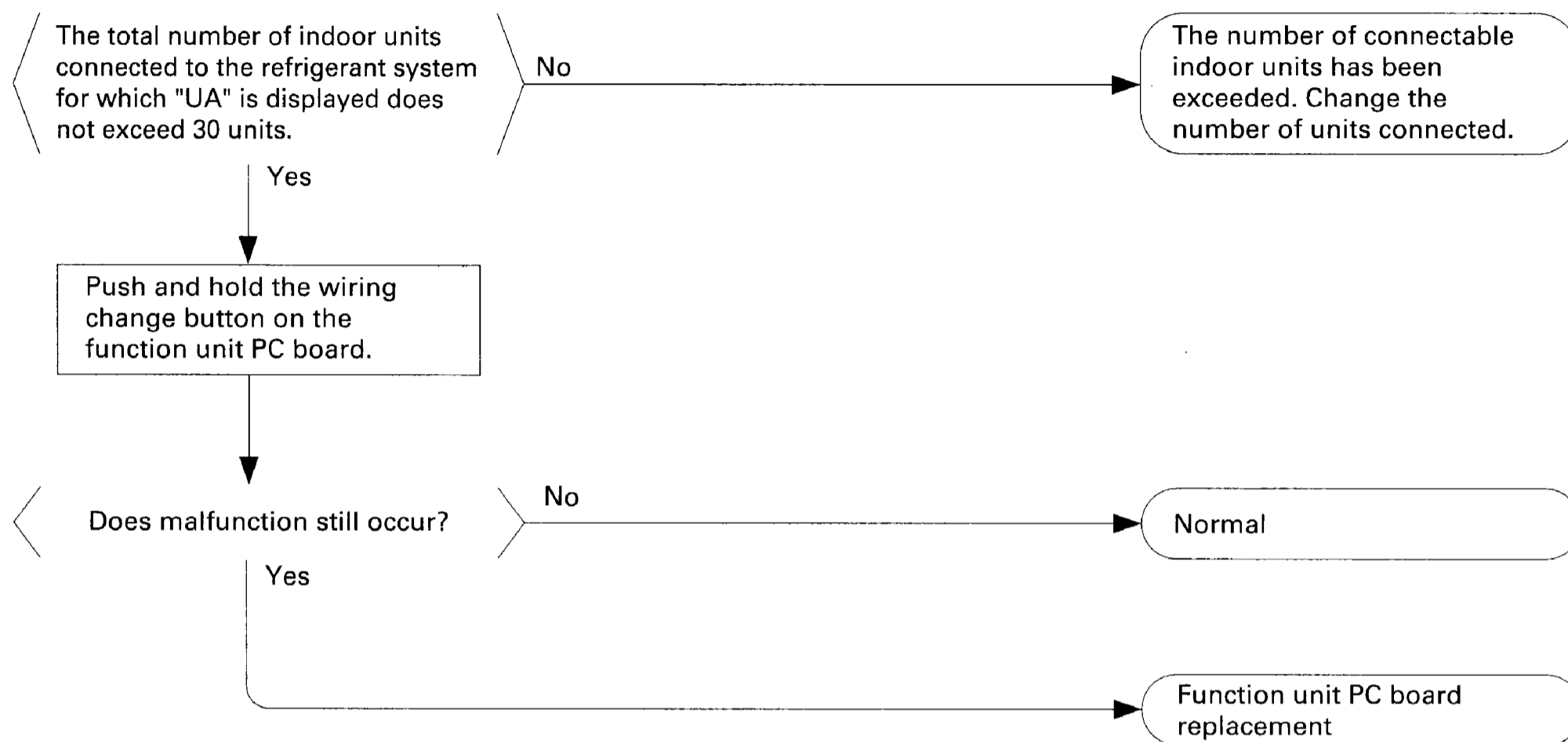

※The number of indoor units that can be connected to outdoor unit 1 system differs according to outdoor unit model.

RXY16K, RXY18K, RXY20K: Max. 20 units

RXY24K, 26K, 28K, 30K: 30 units

## Remote controller display

### Malfunction code "UF" blinks.

#### Cause of malfunction

- (1) Improper connection of transmission wiring between outdoor unit and outdoor unit outside control adaptor
- (2) Failure to execute wiring check operation
- (3) Defect of indoor unit PC board

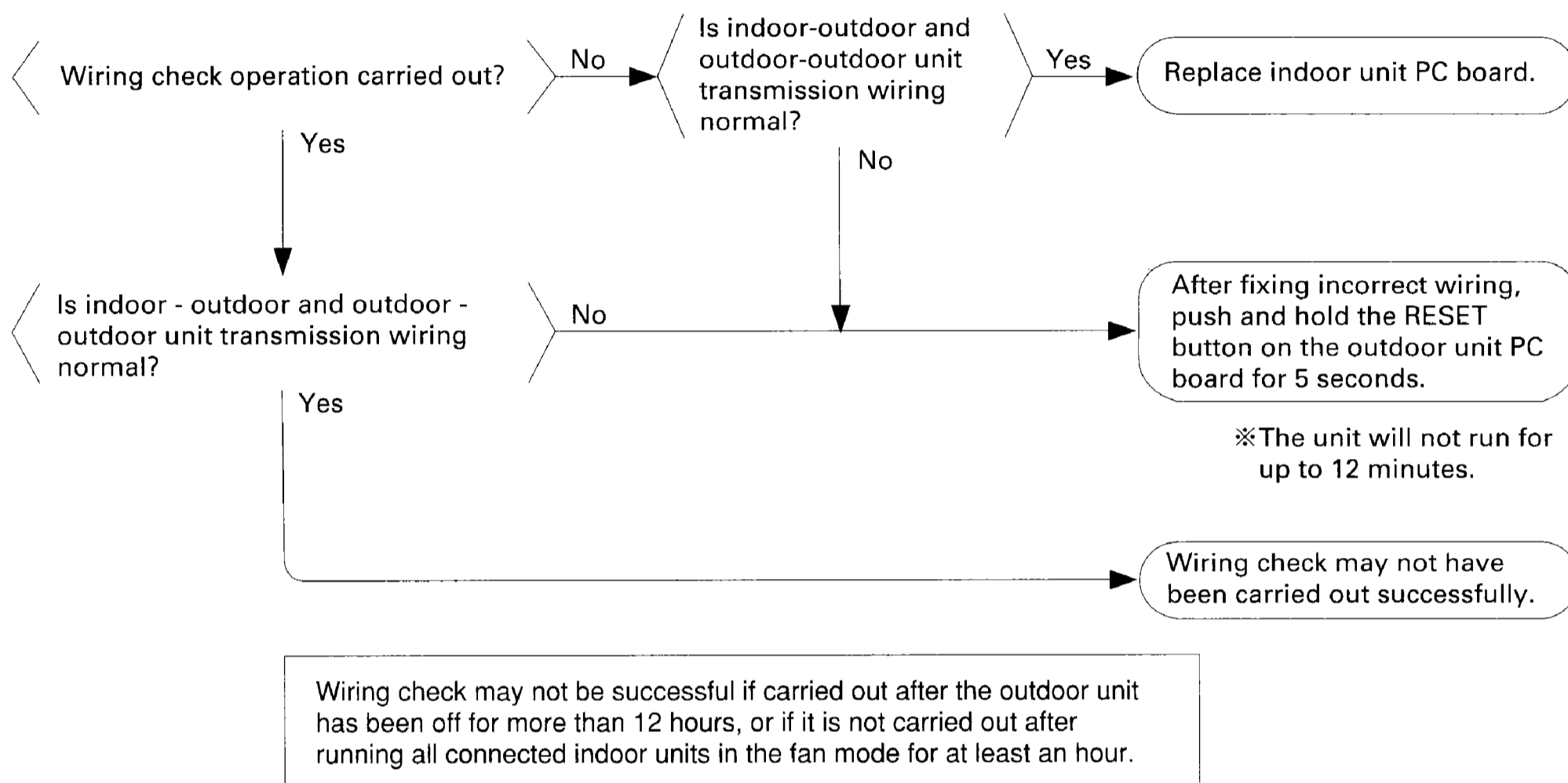

## Remote controller display

### Malfunction code "UH" blinks.

#### Cause of malfunction

- (1) Improper connection of transmission wiring between outdoor unit and outdoor unit outside control adaptor
- (2) Defect of indoor unit PC board
- (3) Defect of outdoor unit PC board (EC1)

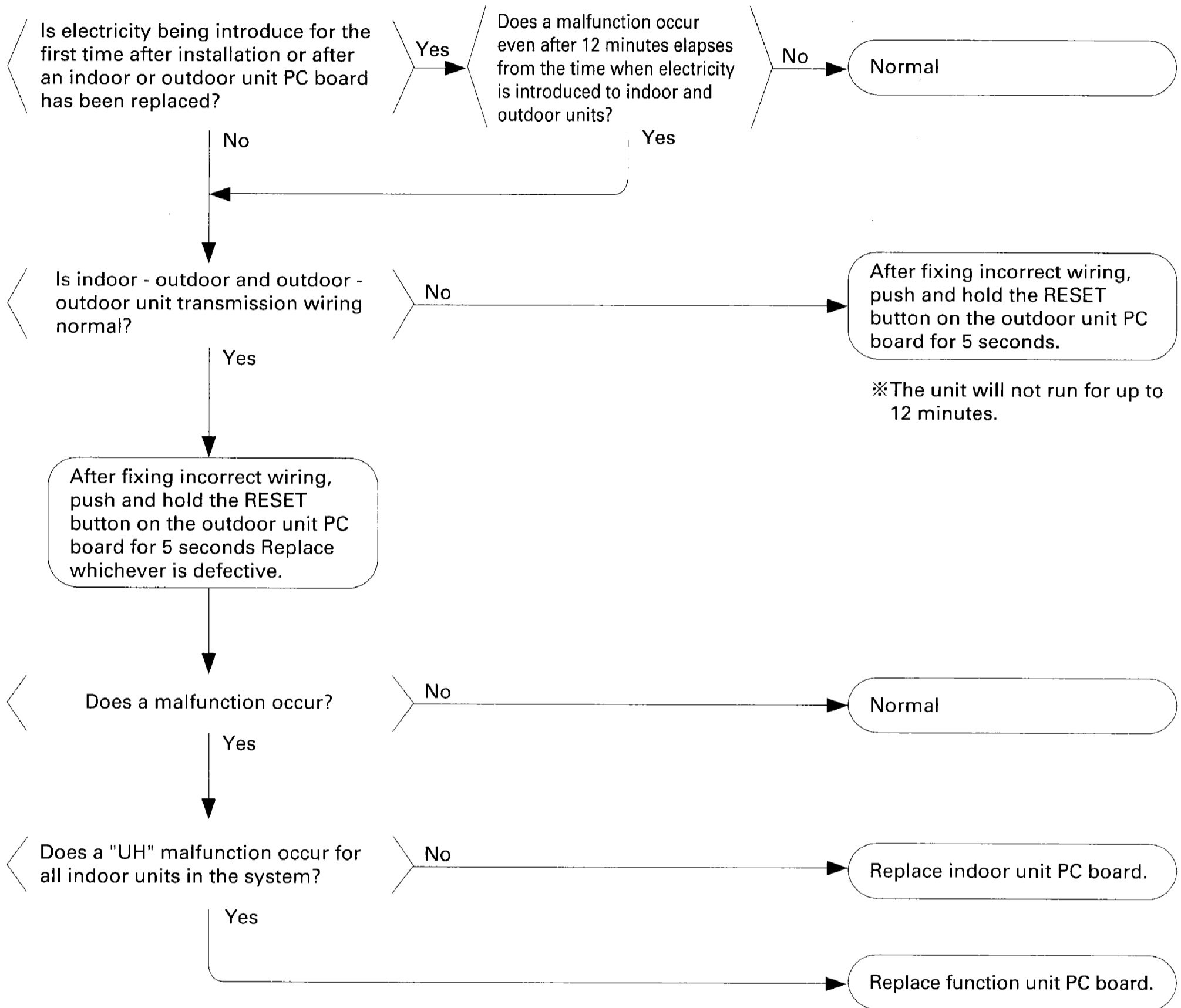

## 4. Failure Diagnosis for Inverter System

### Points of diagnosis

The main causes for each malfunction code are given in the table below. (For details refer to the next page and those following.)

- ◎ : Failure is probable
- : Failure is possible
- △ : Failure is improbable
- : Failure is impossible

Malfunction code	Contents of malfunction	Location of failure							Point of diagnosis
		Inverter		Compressor	Refrigerant system	Outdoor unit PC board	Other	Field cause	
		PC board power unit	Other						
L4	Radiator fin temperature rise	△	◎	—	—	—	—	△	Is the intake port of the radiator fin clogged?
L5	Instantaneous over-current	○	—	◎	△	—	—	—	Inspect the compressor.
L8	Electronic thermostat	△	—	◎	○	—	—	—	Inspect the compressor and refrigerant system.
L9	Stall prevention	△	—	○	◎	—	—	—	Inspect the compressor and refrigerant system.
LC	Malfunction of transmission between inverter PC board and outdoor unit PC board	○	◎	—	—	△	—	—	Inspect the connection between the inverter PC board and outdoor unit PC board. Next, inspect the inverter PC board.
U2	Insufficient current/voltage	○	○	—	—	—	△	◎	<ul style="list-style-type: none"> <li>● Inspect the fuse on the inverter PC board.</li> <li>● Check the DC voltage.</li> </ul>
P1	Over-ripple protection	○	○	—	—	—	—	○	<ul style="list-style-type: none"> <li>● Open phase</li> <li>● Current/voltage imbalance</li> <li>● Defect of main circuit wiring</li> </ul>
P4	Defect of radiator fin temperature sensor	○	△	—	—	—	—	—	Inspect the radiator fin thermistor.



## 5. How to use the Monitor switch on the Inverter PC Board

The monitor lets you know the contents of the latest stop due to malfunction by LED display on the inverter PC Board. The inverter is equipped with a retry function that retries operation each time stop due to malfunction occurs, and malfunction is therefore not ascertained by merely entering the five minutes standby while retry is attempted the prescribed number of times. If the number of retry times is exceeded within 60 minutes, malfunction is ascertained, and the corresponding malfunction code is displayed on the indoor unit remote controller.

LED	A	1	2	3	4	Malfunction contents	Retry times
	◐	●	●	●	●	Normal	
	◐	●	●	●	○	Malfunction of fin thermistor	3
	◐	○	○	●	●	Sensor malfunction	0
	◐	○	●	●	○	Insufficient voltage	3
	◐	●	●	○	●	Instantaneous over-current	3
	◐	●	○	○	○	Electronic thermistor	3
	◐	○	○	○	○	Stall prevention	3
	◐	●	○	●	●	Open phase detection	3
	●	●	●	●	●	Malfunction of microcomputer	Unlimited

- ◐ : Blink
- : On
- : Off

## Remote controller display

### Malfunction code "L4" blinks.

#### Cause of malfunction

(1) Actuation of fin thermal (Actuates at min. 90°C and resets at max. 80°C)

(2) Defect of inverter PC board

(3) Defect of fin thermistor

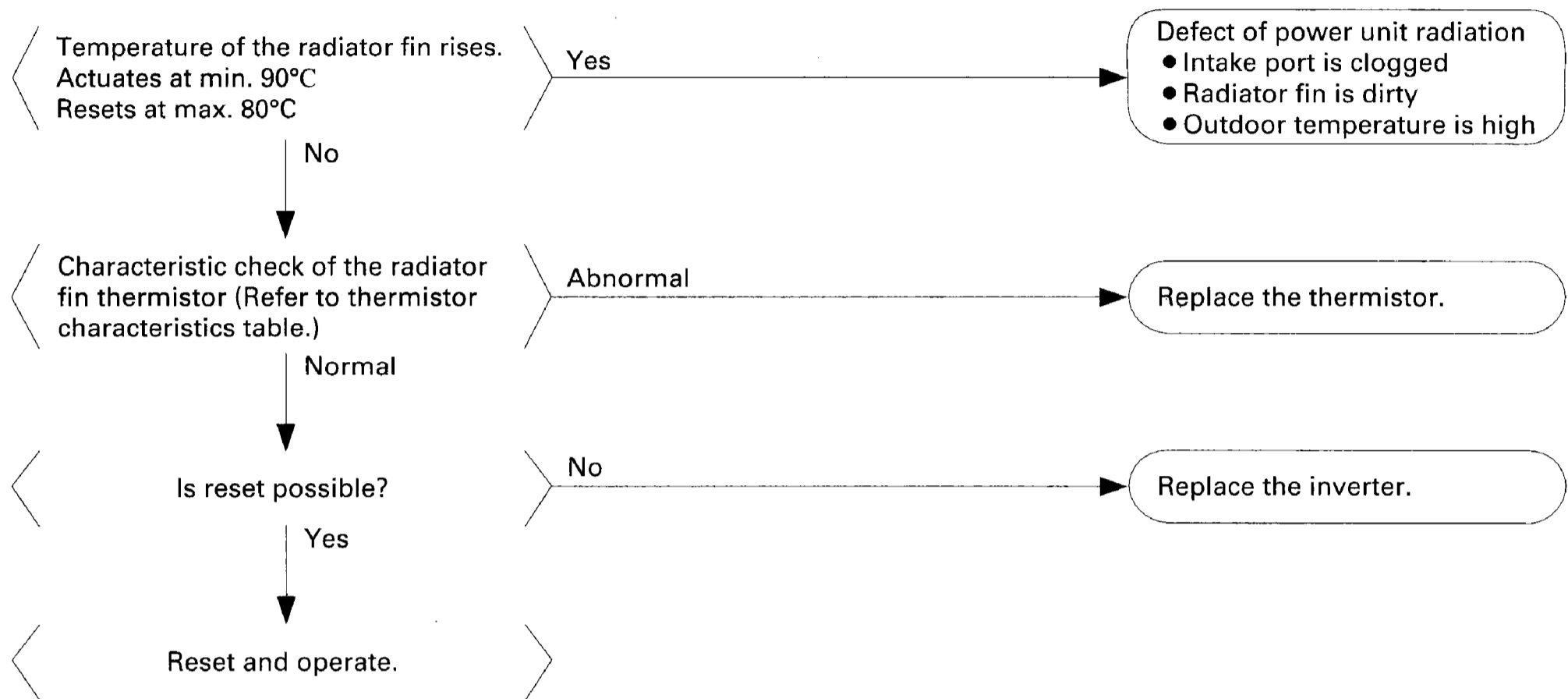

## Remote controller display

### Malfunction code "L5" blinks.

#### Cause of malfunction

- (1) Defect of compressor coil (disconnected, defective insulation)
- (2) Compressor start-up malfunction (mechanical lock)
- (3) Defect of inverter unit

#### Compressor inspection

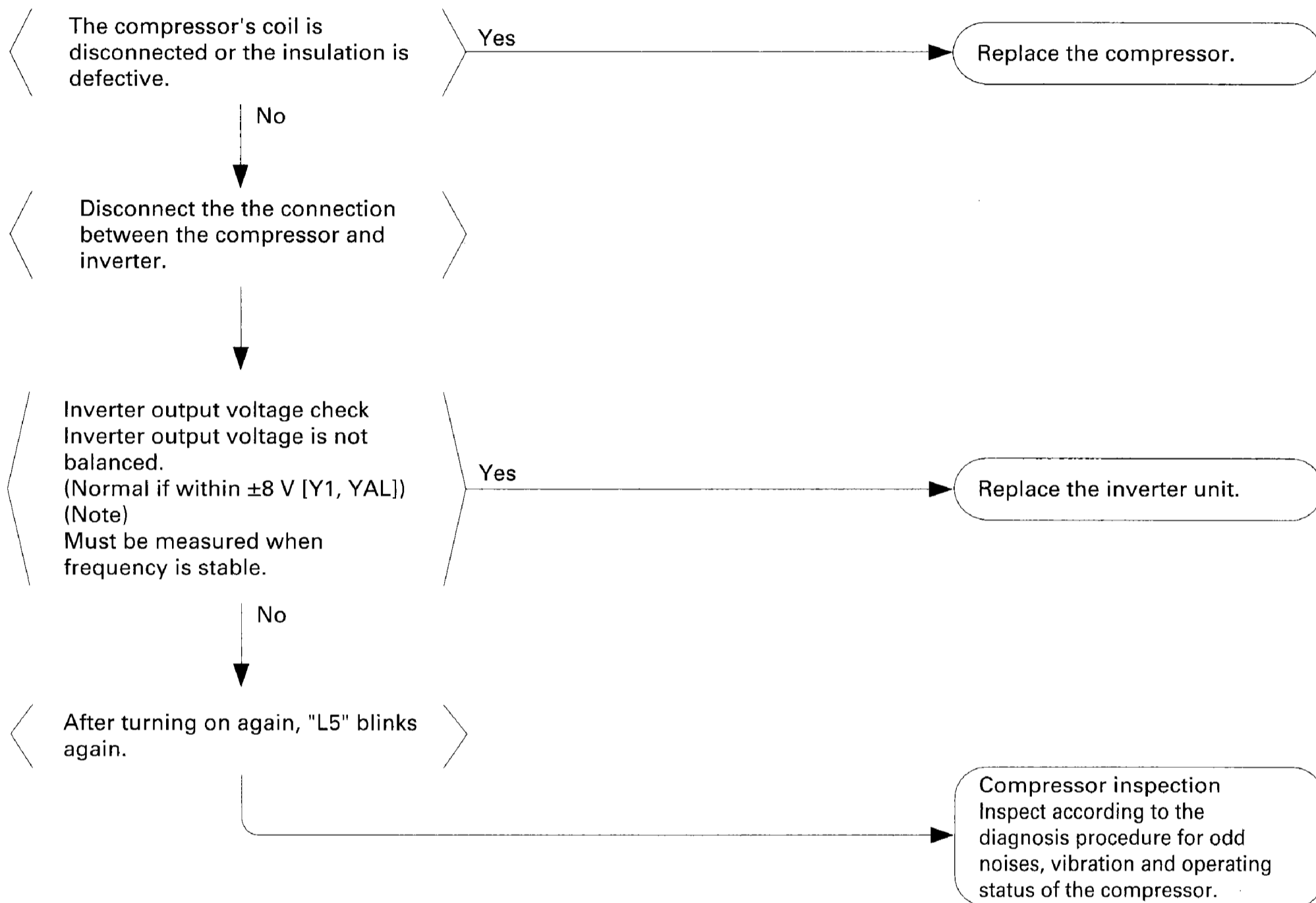

When you measure output voltage of an inverter, the reading is higher than the actual voltage.

## Remote controller display

### Malfunction code "L8" blinks.

#### Cause of malfunction

- (1) Compressor overload
- (2) Compressor coil disconnected
- (3) Defect of inverter unit

#### Output current check

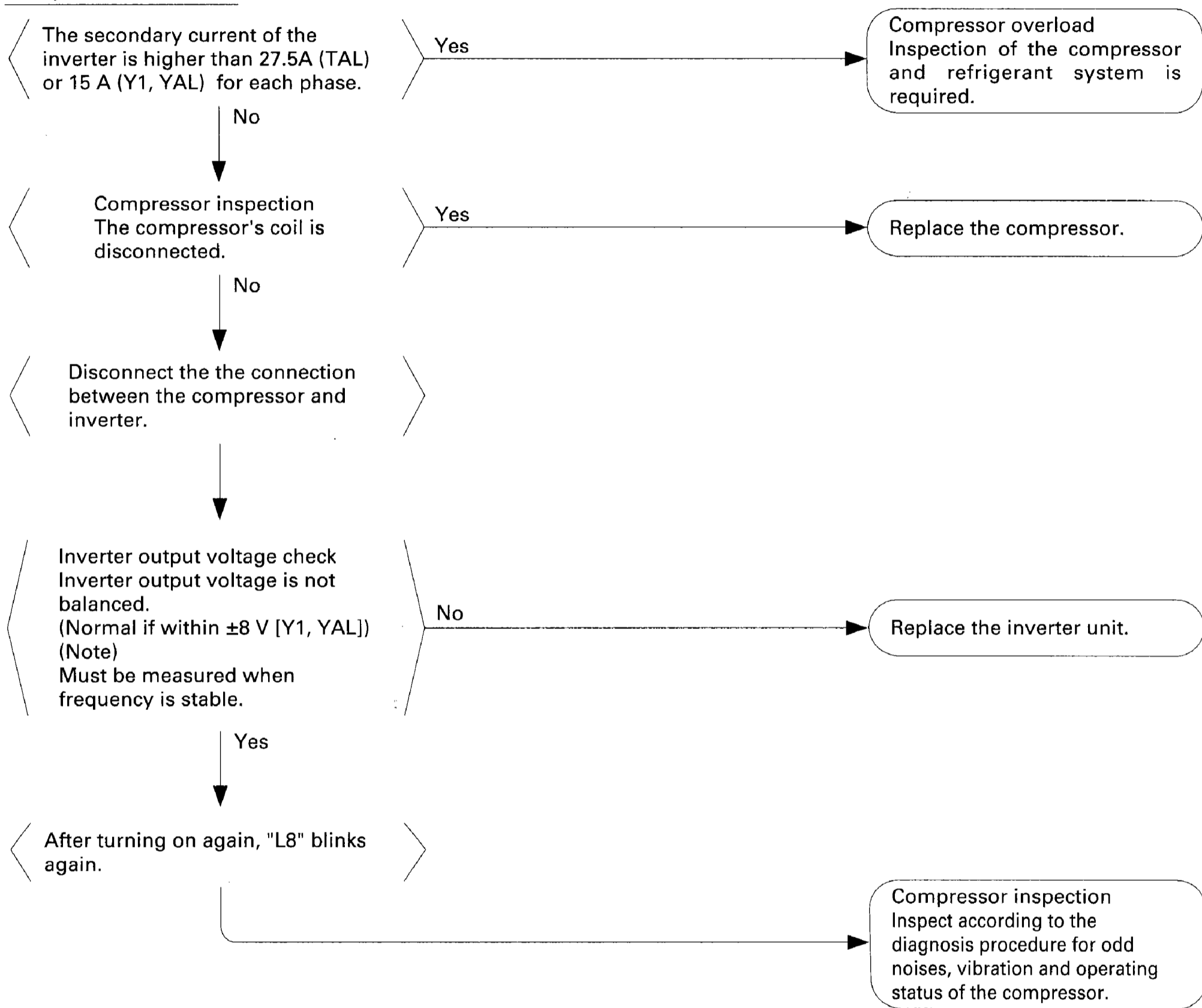

## Remote controller display

### Malfunction code "L9" blinks.

#### Cause of malfunction

- (1) Defect of compressor
- (2) Pressure differential start
- (3) Defect of inverter unit

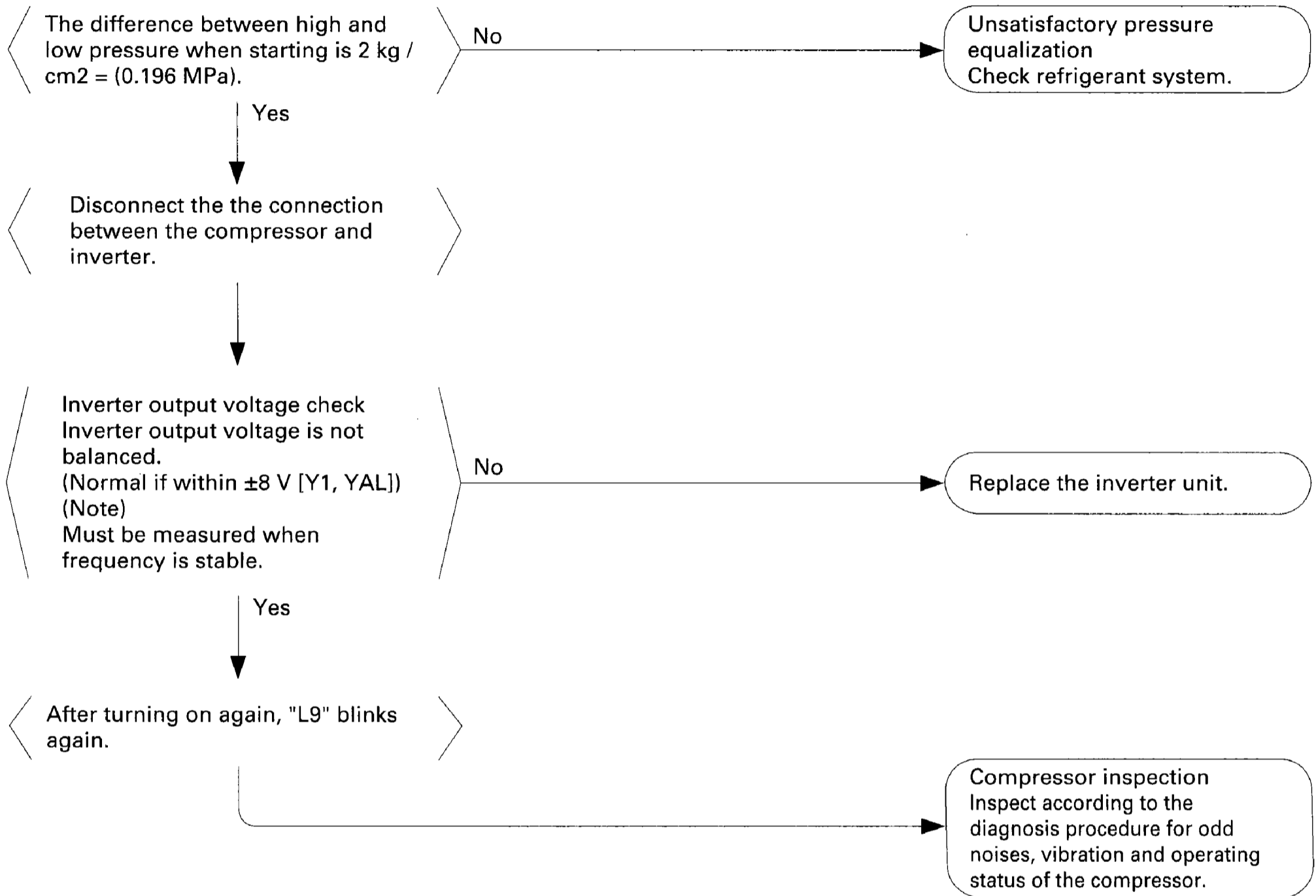

## Remote controller display

### Malfunction code "LC" blinks.

#### Cause of malfunction

- (1) Malfunction of connection between the inverter unit and outdoor unit PC board
- (2) Defect of outdoor unit PC board (transmission section)
- (3) Defect of inverter unit
- (4) Defect of noise filter (NF1)

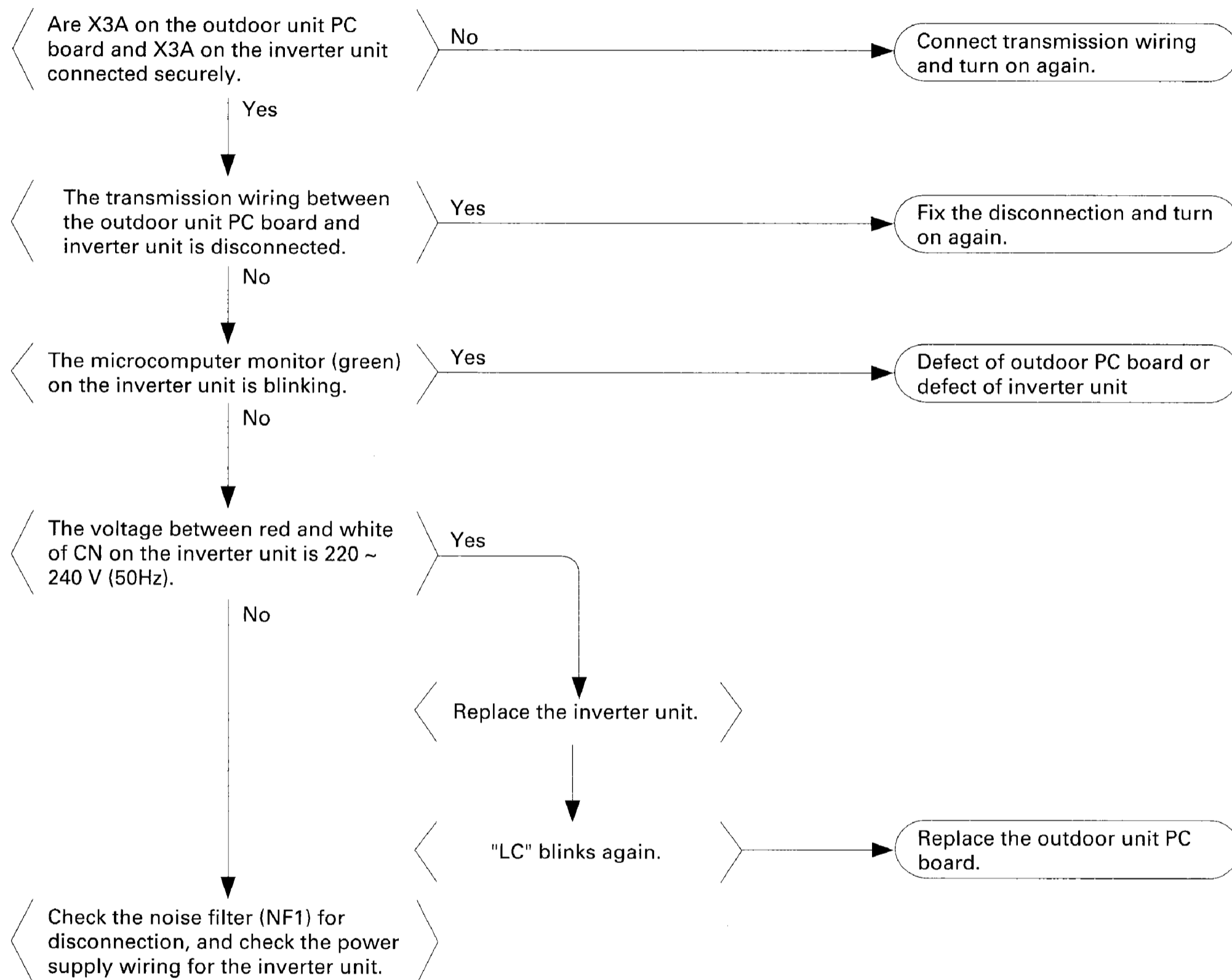

## Remote controller display

### Malfunction code "U2" blinks.

#### Cause of malfunction

- (1) Power supply insufficient
- (2) Instantaneous failure
- (3) Open phase
- (4) Defect of inverter unit
- (5) Defect of outdoor PC board
- (6) Defect of K1M.
- (7) Main circuit wiring defect

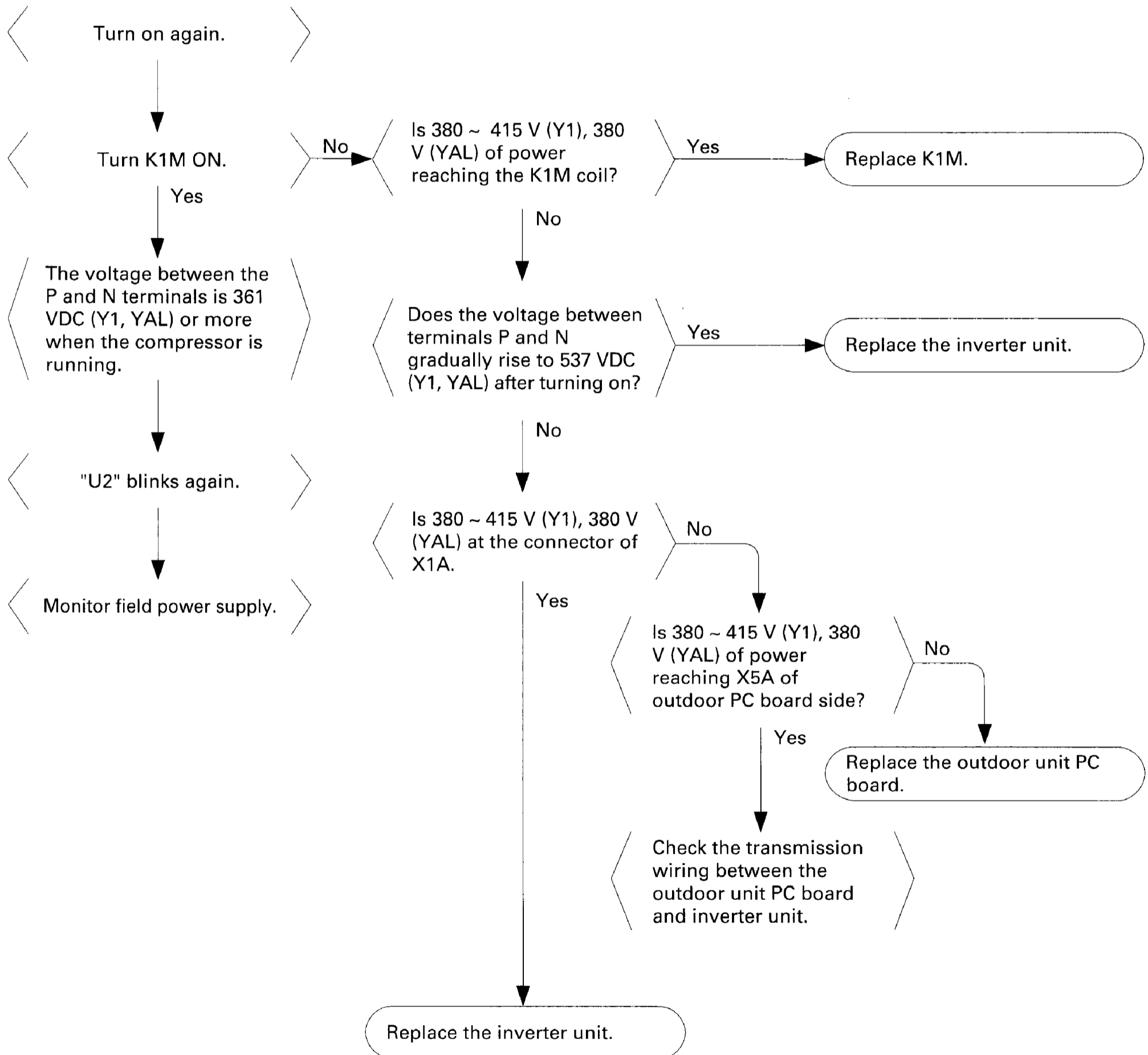

## Remote controller display

### Malfunction code "P1" blinks.

#### Cause of malfunction

- (1) Open phase
- (2) Voltage imbalance between phases
- (3) Defect of main circuit capacitor
- (4) Defect of inverter unit
- (5) Defect of K1M
- (6) Improper main circuit wiring

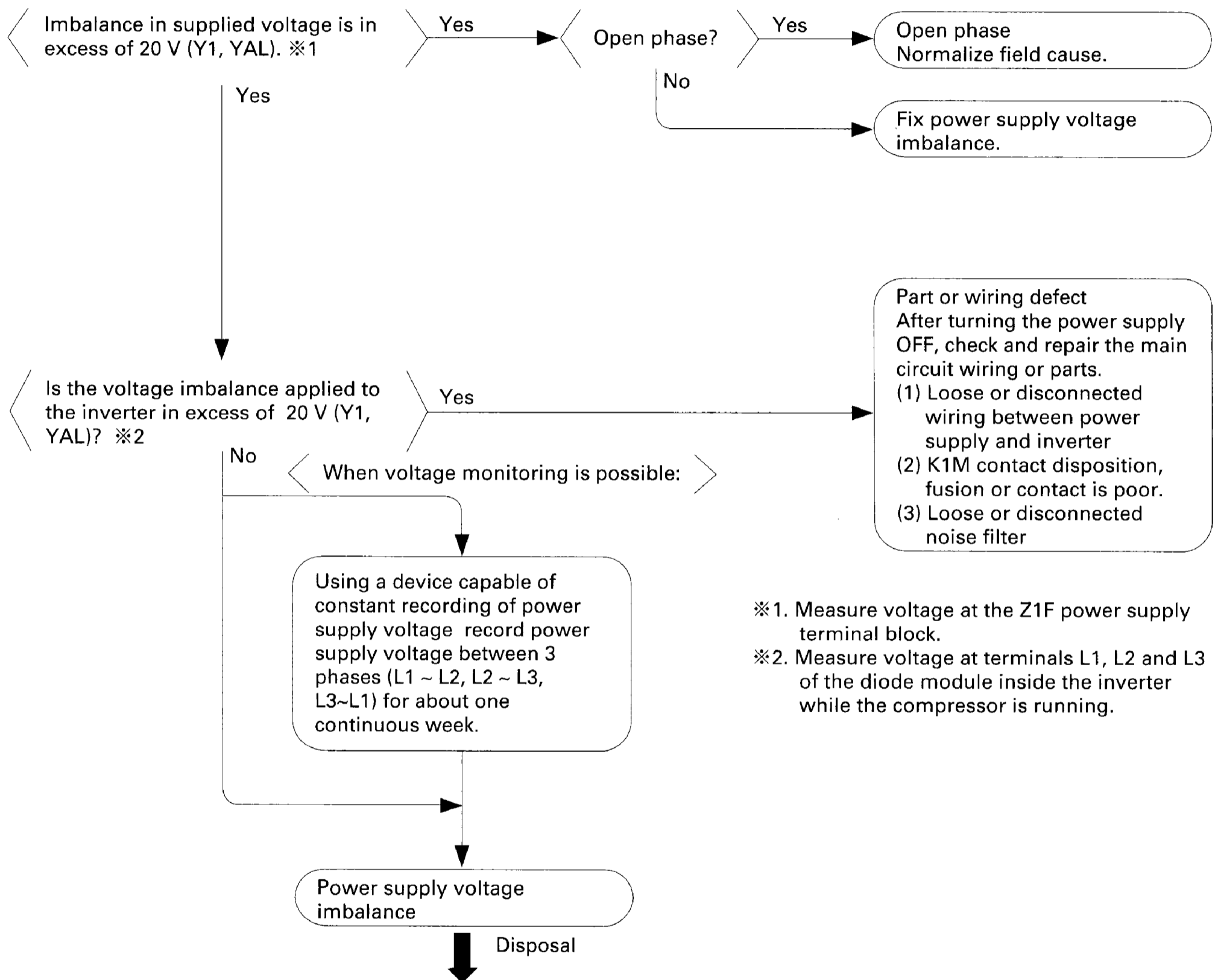

- ※1. Measure voltage at the Z1F power supply terminal block.
- ※2. Measure voltage at terminals L1, L2 and L3 of the diode module inside the inverter while the compressor is running.

Explanation for users	※In accordance with "notification of inspection results" accompanying spare parts.
Give the user a copy of "notification of inspection results" and leave it up to him to improve the imbalance.	Be sure to explain to the user that there is a "power supply imbalance" for which DAIKIN is not responsible.
Contact QC div.	
Be sure to send a product report of the imbalance.	



## Remote controller display

### Malfunction code "P4" blinks.

#### Cause of malfunction

- (1) Defect of radiator fin temperature sensor
- (2) Defect of inverter unit

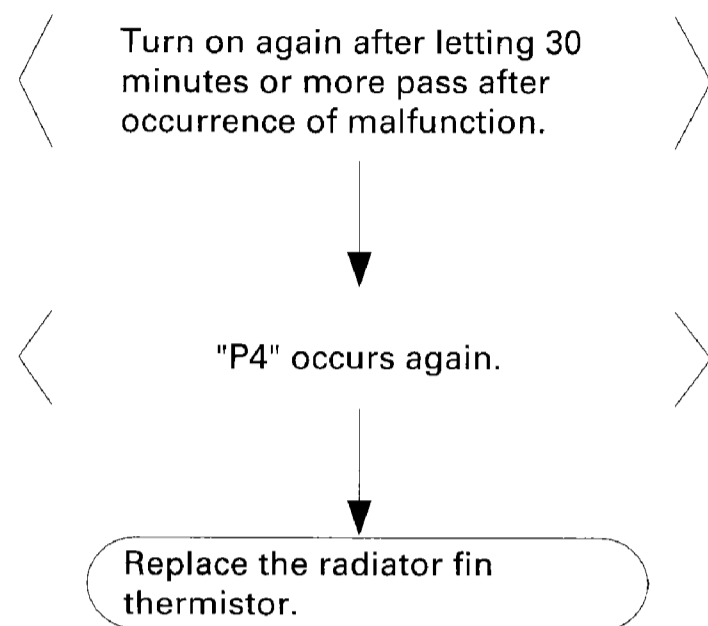

**MEMO**

# **SPECIAL SERVICE MODE**

## **PLUS Series**

# 1. Backup and Emergency Operation

The PLUS Series is equipped with a function whereby, if one outdoor unit becomes unable to operate, the system continues to operate without the faulty unit. You should note that this is accomplished by other methods for other VRV Series.

## (1) Backup Operation: Lets you operate by remote controller when a constant speed type outdoor unit malfunctions.

If a constant speed type outdoor unit malfunctions, if you restart operation by remote controller after the unit stops due to malfunction, you can continue to operate the system minus the faulty constant speed type outdoor unit. Operation however cannot be continued for some error types. (See the table below.)

The system can run by backup operation for up to 3 hours of total indoor unit operating time. When 3 hours is exceeded and the malfunction still remains, the system once again stops due to malfunction. If the malfunction returns to normal, the system continues to operate as is.

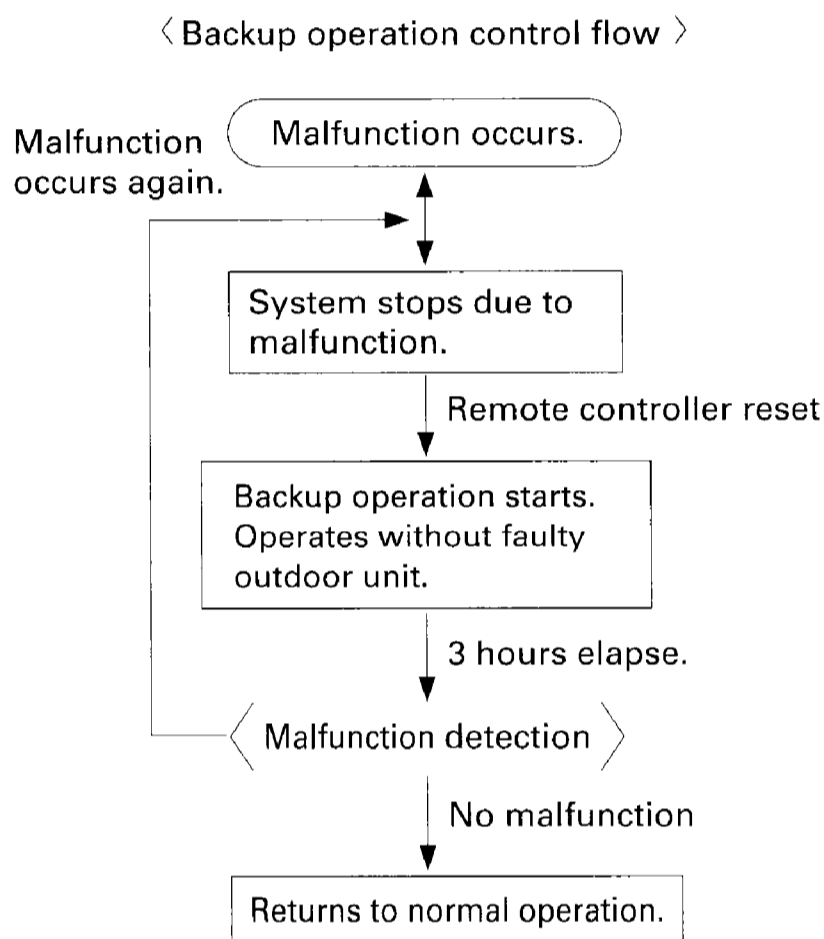

After the system briefly stops due malfunction in order to call attention to the problem, backup operation is started by remote controller.

For the reason described above, after about 3 hours of backup operation, the system again carries out malfunction detection, and the system once again stops due to malfunction if an error is detected.

〈 Malfunctions for which backup operation can or cannot be executed 〉

Malfunction	Malfunction code	PC board type	
		EB9446~9A	EB9446~9B (Applies to items manufactured from June on.)
Tripped safety device	E0	Cannot operate	Can operate
Faulty PC board	E1	Cannot operate	Cannot operate
Tripped LPS	E4	Cannot operate	Can operate
Solenoid valve malfunction	E9	Cannot operate	Can operate
Discharge pipe temperature malfunction	F3	Cannot operate	Can operate
Faulty control HPS	H3	Cannot operate	Cannot operate
Faulty control LPS	H4	Cannot operate	Cannot operate
Air thermistor malfunction	H9	Can operate	Can operate
Discharge pipe thermistor malfunction	J3	Cannot operate	Can operate
Suction pipe thermistor malfunction	J5	Can operate	Can operate
Heat exchange thermistor malfunction	J6	Can operate	Can operate
Oil temperature thermistor malfunction	JH	Can operate	Can operate
Header thermistor malfunction	J7	Can operate	Can operate
Reverse phase / negative phase	U1	Cannot operate	Cannot operate
Outdoor - L transmission malfunction	U7	Cannot operate	Cannot operate

**(2) Emergency Operation: Set in setting mode 2. Operates the system when an outdoor unit malfunctions.**

**① When an inverter type outdoor unit malfunctions (with exception of 13 HP)**

When an inverter type outdoor unit malfunctions, you can continue operation using constant speed type outdoor units only. (Emergency operation cannot be carried out if the inverter type outdoor unit's PC board or pressure sensor is malfunctioning.)

Malfunctions for which emergency operation can or cannot be executed when an inverter type outdoor unit malfunctions

**Emergency operation method**

**When cooling:**

1. Shut the stop valves of the pressure equalizing and liquid pipe of inverter type outdoor unit.
2. Set to "EMG" in setting mode 2.
3. The indoor unit is turned by thermostat at the following minimum capacities:  
 BL2K, BC2K -- 16.8 kW  
 BL3K, BC3K -- 33.6 kW  
 BR2K, BR3K -- All indoor units cool on by thermostat

**When heating:**

1. Shut the stop valves of the gas and liquid pipes of inverter type outdoor unit. (Pressure equalizing pipe open)
2. Set to "EMG" in setting mode 2.
3. The indoor unit is turned by thermostat at the following minimum capacities:  
 BL2K ----- 16.8 kW  
 BL3K ----- 33.6 kW  
 BR2K, BR3K -- All indoor units cool on by thermostat

Malfunction	Malfunction code	Emergency operation
Tripped safety device	E0	Can operate
Faulty PC board	E1	Cannot operate
Tripped HPS	E3	Can operate
Tripped LPS	E4	Can operate
Solenoid valve malfunction	E9	Can operate
Discharge pipe temperature malfunction	F3	Can operate
Air thermistor malfunction	H9	Can operate
Discharge pipe thermistor malfunction	J3	Can operate
Suction pipe thermistor malfunction	J5	Can operate
Heat exchange thermistor malfunction	J6	Can operate
Oil temperature thermistor malfunction	JH	Can operate
Header thermistor malfunction	J7	Can operate
High pressure sensor malfunction	JA	Cannot operate
Low pressure sensor malfunction	JC	Cannot operate
Faulty inverter system	L0	Can operate
Faulty inverter cooling	L4	Can operate
Compressor motor ground fault	L5	Can operate
Compressor overload, disconnection	L8	Can operate
Compressor lock	L9	Can operate
Inverter → outdoor unit PC board transmission malfunction	LC	Can operate
Power supply voltage imbalance	P1	Can operate
Power unit temperature sensor malfunction	P4	Can operate
Reverse phase / negative phase	U1	Cannot operate
Power supply voltage malfunction, instantaneous failure	U2	Can operate
Indoor - outdoor unit transmission failure	U4	Cannot operate
Outdoor ↔ L transmission malfunction	U7	Cannot operate

**[NOTES]**

- Operating range  
 When cooling: Outdoor temp. 10°C or higher  
 When heating: Outdoor temp. -5°C or higher  
 (Safety devices may trip when the outdoor temperature is high.)
- Do not perform emergency operation for 24 hours or more.
- In some cases the indoor unit fan may be L tap when cooling.

**② When a constant speed type outdoor unit malfunctions**

When a constant speed type outdoor unit malfunctions, you can continue to operate by setting to forced backup operation in setting mode 2. With backup operation, you can continue to operate for up to 3 hours, but there is no time restriction for this mode.

Malfunctions for which emergency operation can or cannot be executed when a constant speed type outdoor unit malfunctions

Malfunction	Malfunction code	Emergency operation
Tripped safety device	E0	Can operate
Faulty PC board	E1	Cannot operate
Tripped LPS	E4	Can operate
Solenoid valve malfunction	E9	Can operate
Discharge pipe temperature malfunction	F3	Can operate
Faulty control HPS	H3	Cannot operate
Faulty control LPS	H4	Cannot operate
Air thermistor malfunction	H9	Can operate
Discharge pipe thermistor malfunction	J3	Can operate
Suction pipe thermistor malfunction	J5	Can operate
Heat exchange thermistor malfunction	J6	Can operate
Oil temperature thermistor malfunction	JH	Can operate
Header thermistor malfunction	J7	Can operate
Reverse phase / negative phase	U1	Cannot operate
Outdoor ↔ L transmission malfunction	U7	Cannot operate

## 2. Pump Down Operation When Replacing the Compressor

Pump down operation is when refrigerant is removed from an outdoor unit if it malfunctions. In this case, outdoor units operate in the cooling mode and indoor units are automatically turned on by thermostat.

### [Method]

1. Fully shut stop valves of the liquid and pressure equalizing pipes of the unit from which you want to pump down refrigerant.  
(Pressure equalizing pipe open for simultaneous cool/heat type)
2. Set to pump down mode in setting mode 2 and execute pump down operation.  
(See the following page for details.)
  - For the simultaneous cool/heat type, it takes 3 ~ 10 minutes for the compressor to start operating.
  - LED 23 ~ 26 are for monitoring low pressure during operation.
  - Outdoor units stop for approximately 1 hour.
3. After about 50 minutes, shut the stop valve of the gas pipe. (Outdoor units stop for approximately 1 hour.)
4. Operation is complete if after 10 minutes elapse the pressure of the pumped down outdoor unit is ambient temperature equivalent saturation pressure or lower. If not, repeat steps 1 ~ 4.
5. Purge the remaining pressure and perform servicing.
6. After sealing and vacuum drying, fill with gas until ambient temperature equivalent saturation pressure is reached.
7. Shut the stop valve.

[NOTE] Perform the procedure when outdoor temperature is in the range of 10°C ~ 35°C.

# [Setting mode 2 pump down procedure]

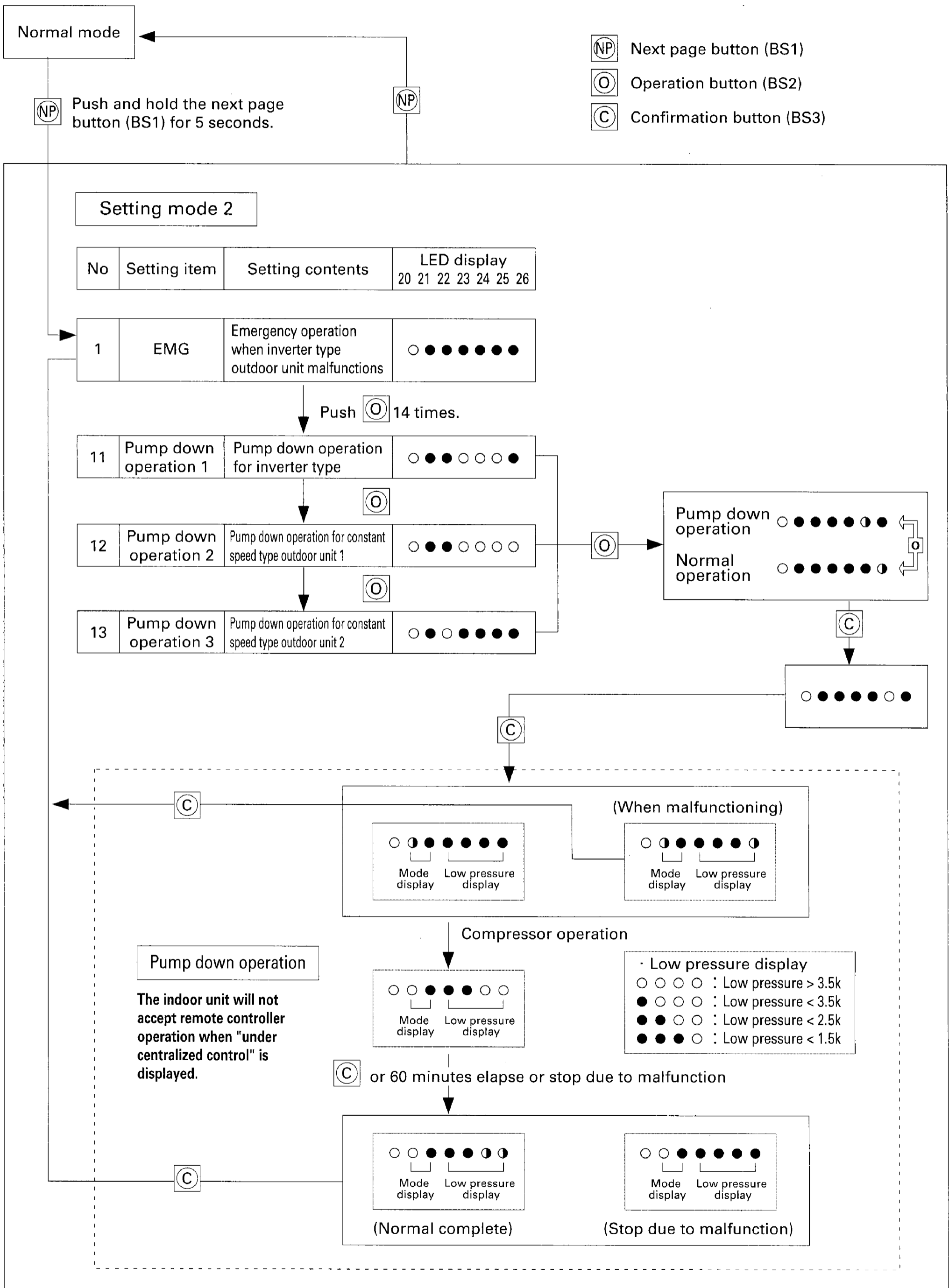

**MEMO**



# **APPENDIX**

## **Inveter K Series PLUS Series**

# 1. Wiring Diagrams

(1) Inverter K Series (Heat pump)

[50Hz 380~415V]

● RSXY5KY1

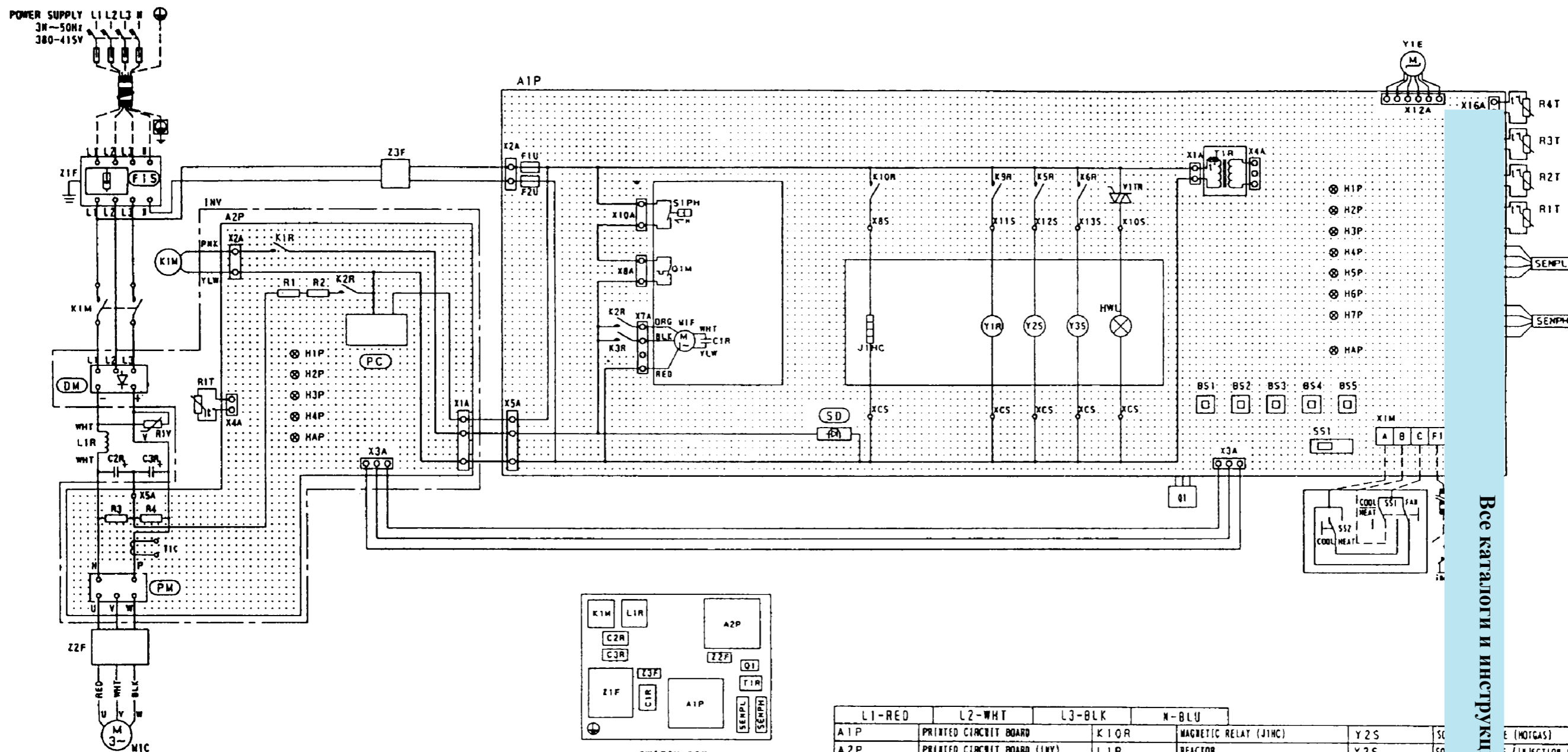

## NOTES)

- : TERMINAL   
  : CONNECTOR   
  : PROTECTIVE EARTH (SCREW)  
 : WIRE CLAMP   
 - - - - : FIELD WIRING

- COLORS:  
 BLK:BLACK RED:RED BUL:BLUE WHT:WHITE YLW:YELLOW ORG:ORANGE BRN:BROWN PNK:PINK GRN:GREEN GRY:GREY
- REFER TO THE INSTALLATION MANUAL, FOR CONNECTION WIRING TO INDOOR-OUTDOOR TRANSMISSION F1 · F2, OUTDOOR-OUTDOOR TRANSMISSION F1 · F2. REFER TO INSTALLATION MANUAL ATTACHED TO THE CENTRAL REMOTE CONTROLLER, WHEN CONNECTING THE CENTRAL REMOTE CONTROLLER.
- THIS WIRING DIAGRAM IS APPLIED ONLY TO THE OUTDOOR UNIT.

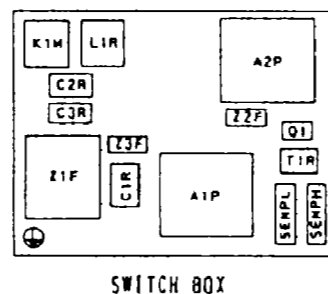

	L1-RED	L2-WHT	L3-BLK	N-BLU		
A1P	PRINTED CIRCUIT BOARD		K10R	MAGNETIC RELAY (J1HC)	Y2S	SC
A2P	PRINTED CIRCUIT BOARD (INV)		L1R	REACTOR	Y3S	SC
BS1-5	PUSH BUTTON SWITCH (MODE, SET, RETURN, WIRING CHECK, RESET)		M1C	MOTOR (COMPRESSOR)	Z1F-3F	NC
C1R-3R	CAPACITOR		M1F	MOTOR (FAN)	(DM)	DE
F1U-2U	FUSE (250V, 10A)		Q1	POWER TRANSISTOR	(FIS)	SU
H1P-7P	LIGHT EMITTING DIODE (SERVICE MONITOR -ORANGE)(A1P)		R1-4	RESISTOR	(PC)	PC
H1P-4P	LIGHT EMITTING DIODE (SERVICE MONITOR -RED)(A2P)		R1T	THERMISTOR (F1R) (A2P)	(SD)	SA
HAP	LIGHT EMITTING DIODE (SERVICE MONITOR -GREEN)(A1P)		R2T	THERMISTOR (AIR) (A1P)		
HAP	LIGHT EMITTING DIODE (SERVICE MONITOR -GREEN)(A2P)		R3T	THERMISTOR (COIL)		
HWL	PILOT LAMP (ALARM-WHITE)		R4T	THERMISTOR (DISCHARGE)		
INV	INVERTER (A2P)		R1V	THERMISTOR (SUCTION)		
J1HC	CRANKCASE HEATER		SEMPH	VARIATOR		
K1M	MAGNETIC CONTACTOR (NIC)		SEMPH	PRESSURE SENSOR (HIGH)		
K2R-2R	MAGNETIC RELAY (A2P)		SS1	PRESSURE SENSOR (LOW)		
K2R-3R	MAGNETIC RELAY (M1F)		SS1	SELECTOR SWITCH (C/W SELECT)		
K5R	MAGNETIC RELAY (Y2S)		S1PH	PRESSURE SWITCH (HIGH)		
K6R	MAGNETIC RELAY (Y3S)		T1R	DC CURRENT TRANSFORMER		
K9R	MAGNETIC RELAY (Y1R)		V1TR	SOLID STATE RELAY	OPTIONAL PAF	
			X1M	TERMINAL STRIP	COOL/HEAT S	
			Y1E	EXPANSION VALVE (ELECTRONIC TYPE)	SS1	SE
			Y1R	4 WAY VALVE	SS2	SE

Все каталоги и инструкции здесь: <https://sp>

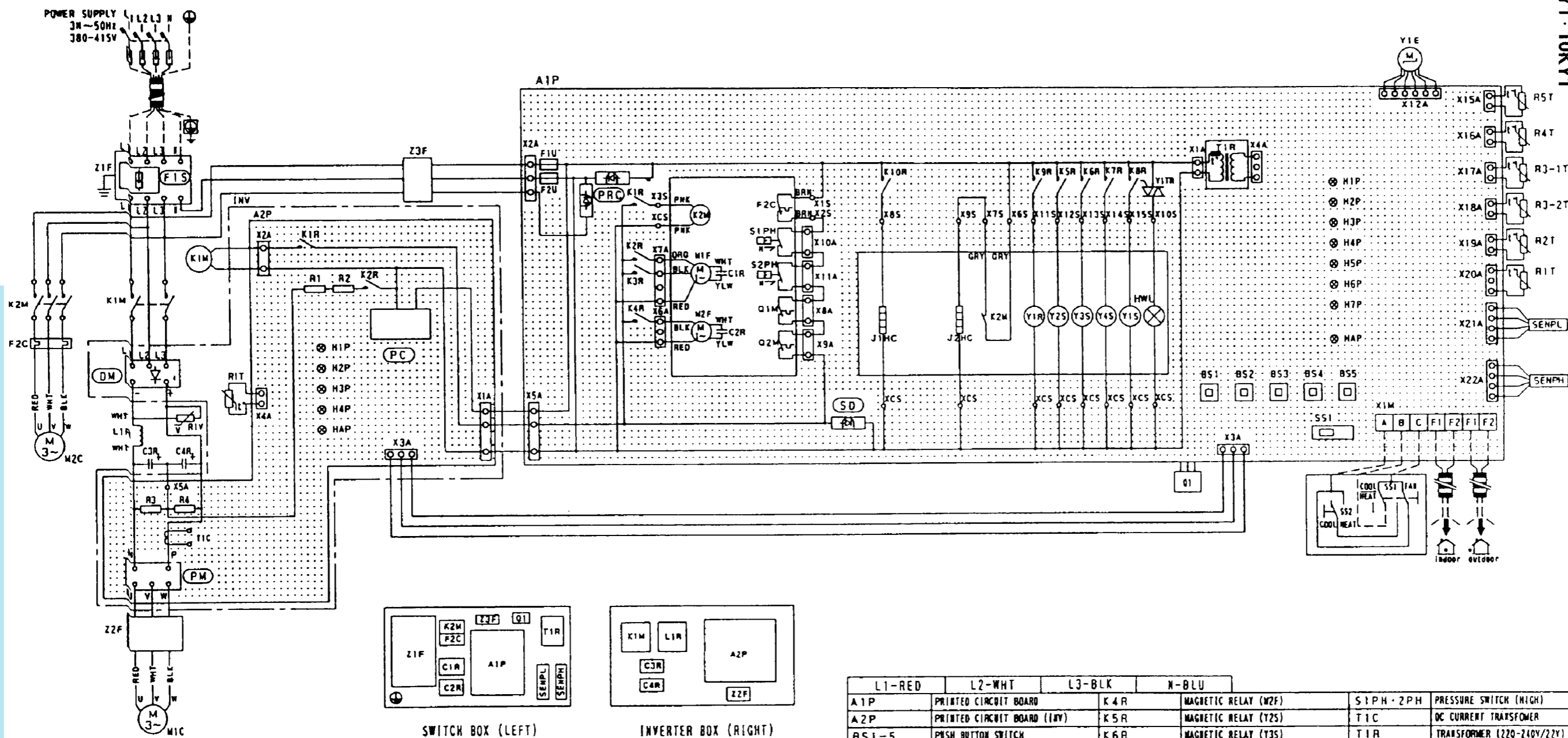

NOTES

- : TERMINAL    ○: CONNECTOR    Ⓜ: PROTECTIVE EARTH (SCREW)

○: WIRE CLAMP    - - - - : FIELD WIRING
- COLORS:

BLK:BLACK RED:RED BLU:BLUE WHT:WHITE YLW:YELLOW ORG:ORANGE BRN:BROWN PKK:PINK GRM:GREEN GRY:GREY
- REFER TO THE INSTALLATION MANUAL, FOR CONNECTION WIRING TO INDOOR-OUTDOOR TRANSMISSION F1 · F2, OUTDOOR-OUTDOOR TRANSMISSION F1 · F2. REFER TO INSTALLATION MANUAL ATTACHED TO THE CENTRAL REMOTE CONTROLLER, WHEN CONNECTING THE CENTRAL REMOTE CONTROLLER.
- THIS WIRING DIAGRAM IS APPLIED ONLY TO THE OUTDOOR UNIT.

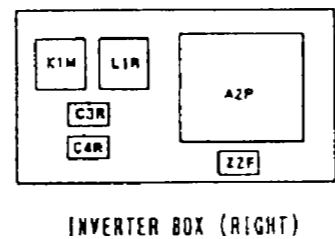
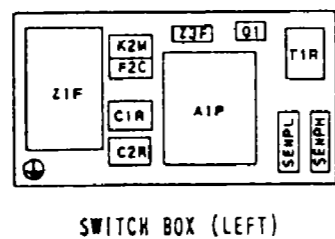

	L1-RED	L2-WHT	L3-BLK	N-BLU	
A1P	PRINTED CIRCUIT BOARD		K4R	MAGNETIC RELAY (W2F)	S1PH · 2PH PRESSURE SWITCH (HIGH)
A2P	PRINTED CIRCUIT BOARD (INV)		K5R	MAGNETIC RELAY (Y2S)	T1C DC CURRENT TRANSFORMER
BS1-5	PNH BUTTON SWITCH (MODE, SET, RETURN, WIRING CHECK, RESET)		K6R	MAGNETIC RELAY (Y3S)	T1R TRANSFORMER (220-240V/22Y)
C1R-4R	CAPACITOR		K7R	MAGNETIC RELAY (Y4S)	Y1TR SOLID STATE RELAY
F2C	OVER CURRENT RELAY (M2C)		K8R	MAGNETIC RELAY (Y1S)	X1M TERMINAL STRIP
F1U · 2U	FUSE (250V, 10A)		K9R	MAGNETIC RELAY (Y1R)	Y1E EXPANSION VALVE (ELECTRONIC TYPE)
H1P-7P	LIGHT EMITTING DIODE (SERVICE MONITOR -ORANGE) (A1P)		K10R	MAGNETIC RELAY (J1MC)	Y1R 4 WAY VALVE
H1P-4P	LIGHT EMITTING DIODE (SERVICE MONITOR -RED) (A2P)		L1R	REACTOR	Y1S SOLENOID VALVE (HOTGAS COULIZING)
HAP	LIGHT EMITTING DIODE (SERVICE MONITOR -GREEN) (A1P)		M1C · 2C	MOTOR (COMPRESSOR)	Y2S SOLENOID VALVE (HOTGAS)
HAP	LIGHT EMITTING DIODE (SERVICE MONITOR -GREEN) (A2P)		M1F · 2F	MOTOR (FAN)	Y3S SOLENOID VALVE (INJECTION MIC)
HAP	LIGHT EMITTING DIODE (SERVICE MONITOR -GREEN) (A1P)		Q1	POWER TRANSISTOR	Y4S SOLENOID VALVE (INJECTION W2C)
HAP	LIGHT EMITTING DIODE (SERVICE MONITOR -GREEN) (A2P)		Q1M · 2M	THERMO SWITCH (W1F, W2F)	Z1F-3F ROIZE FILTER
HAP	LIGHT EMITTING DIODE (SERVICE MONITOR -GREEN) (A2P)		R1-4	RESISTOR	(DM) DIODE MODULE
HAP	LIGHT EMITTING DIODE (SERVICE MONITOR -GREEN) (A2P)		R1T	THERMISTOR (FIN) (A2P)	(F1S) SURGE ABSORBER
HAP	LIGHT EMITTING DIODE (SERVICE MONITOR -GREEN) (A2P)		R1T	THERMISTOR (AIR) (A1P)	(PC) POWER CIRCUIT
HAP	LIGHT EMITTING DIODE (SERVICE MONITOR -GREEN) (A2P)		R2T	THERMISTOR (COIL)	(PM) POWER MODULE
HAP	LIGHT EMITTING DIODE (SERVICE MONITOR -GREEN) (A2P)		R3-1T · 2T	THERMISTOR (DISCHARGE)	(PRC) PHASE REVERSAL DEFECT CIRCUIT
HAP	LIGHT EMITTING DIODE (SERVICE MONITOR -GREEN) (A2P)		R4T	THERMISTOR (SACTION)	(SD) SAFETY DEVICES INPUT
HAP	LIGHT EMITTING DIODE (SERVICE MONITOR -GREEN) (A2P)		R5T	THERMISTOR (OIL)	
HAP	LIGHT EMITTING DIODE (SERVICE MONITOR -GREEN) (A2P)		R1V	VARISTOR	OPTIONAL PARTS
HAP	LIGHT EMITTING DIODE (SERVICE MONITOR -GREEN) (A2P)		SENPH	PRESSURE SENSOR (HIGH)	COOL/HEAT SELECTOR (KRC19-26)
HAP	LIGHT EMITTING DIODE (SERVICE MONITOR -GREEN) (A2P)		SENPL	PRESSURE SENSOR (LOW)	SS1 SELECTOR SWITCH (FAN/COOL · HEAT)
HAP	LIGHT EMITTING DIODE (SERVICE MONITOR -GREEN) (A2P)		SS1	SELECTOR SWITCH (C/M SELECT)	SS2 SELECTOR SWITCH (COOL/HEAT)

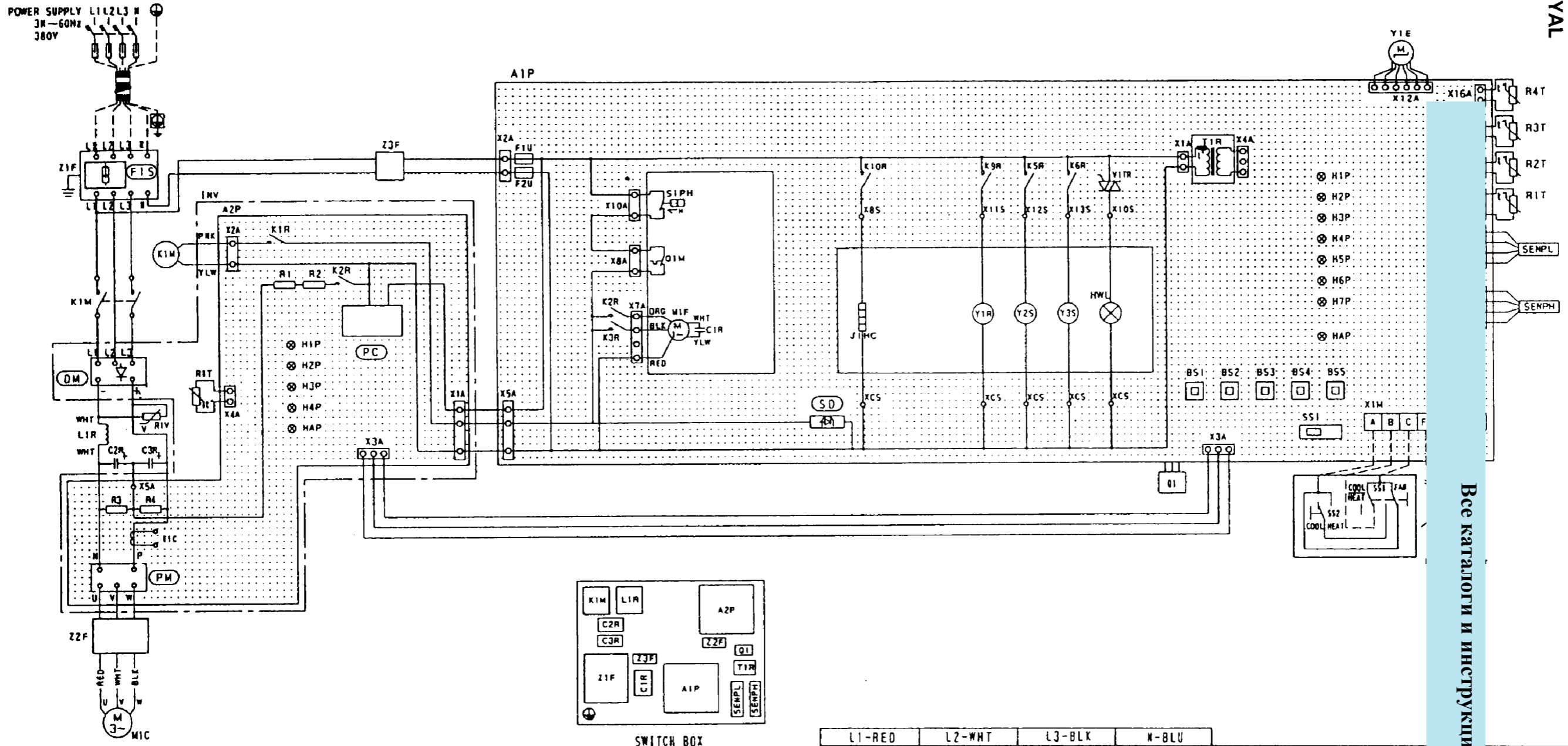

NOTES)

- : TERMINAL    ⊙: CONNECTOR    ⊕: PROTECTIVE EARTH (SCREW)

○: WIRE CLAMP    - - - : FIELD WIRING
- COLORS:

BLK:BLACK RED:RED BUL:BLUE WHT:WHITE YLW:YELLOW ORG:ORANGE BRN:BROWN PNK:PINK GRN:GREEN GRY:GREY
- REFER TO THE INSTALLATION MANUAL, FOR CONNECTION WIRING TO INDOOR-OUTDOOR TRANSMISSION F1 · F2, OUTDOOR-OUTDOOR TRANSMISSION F1 · F2, REFER TO INSTALLATION MANUAL ATTACHED TO THE CENTRAL REMOTE CONTROLLER, WHEN CONNECTING THE CENTRAL REMOTE CONTROLLER.
- THIS WIRING DIAGRAM IS APPLIED ONLY TO THE OUTDOOR UNIT.

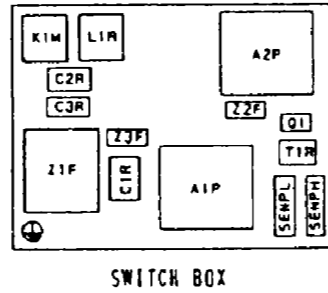

	L1-RED	L2-WHT	L3-BLK	N-BLU	
A1P	PRINTED CIRCUIT BOARD		K6R	MAGNETIC RELAY (Y3S)	V1TR
A2P	PRINTED CIRCUIT BOARD (INV)		K9R	MAGNETIC RELAY (Y1R)	X1M
BS1-5	PUSH BUTTON SWITCH (MODE, SET, RETURN, WIRING CHECK, RESET)		K10R	MAGNETIC RELAY (J1HC)	Y1E
C1R-3R	CAPACITOR		L1R	REACTOR	Y1R
F1U-2U	FUSE (250V, 10A)		M1C	MOTOR (COMPRESSOR)	Y2S
H1P-7P	LIGHT EMITTING DIODE (SERVICE MONITOR -ORANGE) (A1P)		M1F	MOTOR (FAN)	Y3S
H1P-4P	LIGHT EMITTING DIODE (SERVICE MONITOR -RED) (A2P)		Q1	POWER TRANSISTOR	Z1F-3F
HAP	LIGHT EMITTING DIODE (SERVICE MONITOR -GREEN) (A1P)		Q1M	THERMO SWITCH (M1F)	DM
HAP	LIGHT EMITTING DIODE (SERVICE MONITOR -GREEN) (A2P)		R1-4	RESISTOR	F1S
HAP	LIGHT EMITTING DIODE (SERVICE MONITOR -ORANGE) (A1P)		R1T	THERMISTOR (FIR) (A2P)	PC
HAP	LIGHT EMITTING DIODE (SERVICE MONITOR -GREEN) (A2P)		R2T	THERMISTOR (AIR) (A1P)	PM
HAP	LIGHT EMITTING DIODE (SERVICE MONITOR -GREEN) (A2P)		R3T	THERMISTOR (COIL)	SD
HAP	LIGHT EMITTING DIODE (SERVICE MONITOR -GREEN) (A2P)		R4T	THERMISTOR (DISCHARGE)	
HWL	PILOT LAMP (ALARM-WHITE)		R1V	VARISTOR	
INV	INVERTER (A2P)		SENPH	PRESSURE SENSOR (HIGH)	
J1HC	CRANKCASE HEATER		SENPL	PRESSURE SENSOR (LOW)	
K1M	MAGNETIC CONTACTOR (M1C)		SS1	SELECTOR SWITCH (C/N SELECT)	OPTIONAL PART
K1R-2R	MAGNETIC RELAY (A2P)		S1PH	PRESSURE SWITCH (HIGH)	COOL/HEAT S
K2R-3R	MAGNETIC RELAY (M1F)		T1C	DC CURRENT TRANSFORMER	SS1
K5R	MAGNETIC RELAY (Y2S)		T1R	TRANSFORMER (220V/22V)	SS2

Все каталоги и инструкции здесь: <https://sp>

[60Hz 380V]

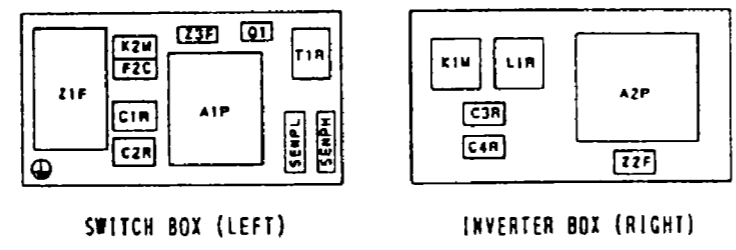
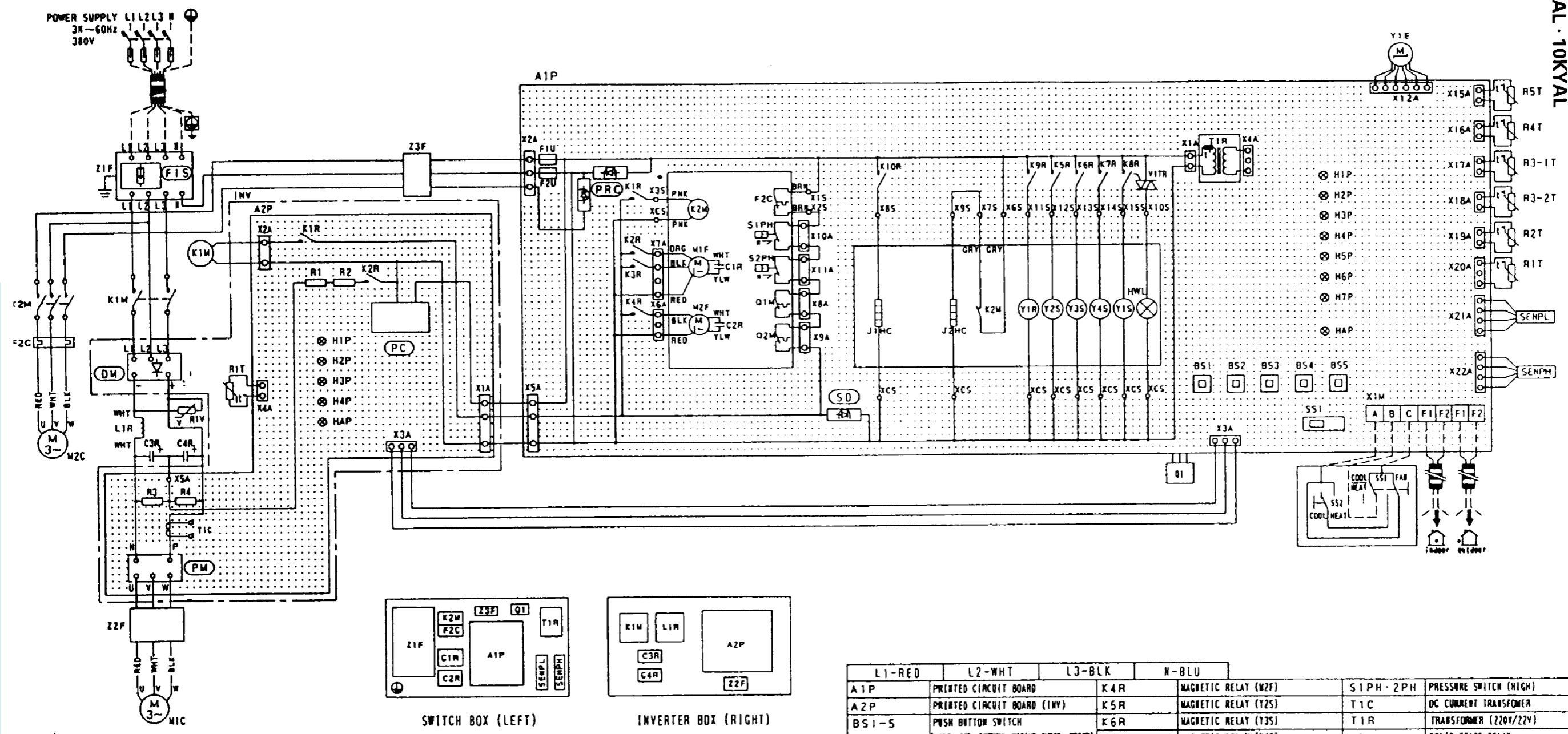

- NOTES)**
- : TERMINAL    : CONNECTOR    : PROTECTIVE EARTH (SCREW)  
 : WIRE CLAMP    - - - : FIELD WIRING
  - COLORS:**  
 BLK:BLACK RED:RED BLU:BLUE WHT:WHITE YLW:YELLOW ORG:ORANGE BRN:BROWN PNK:PINK GRN:GREEN GRY:GREY
  - REFER TO THE INSTALLATION MANUAL, FOR CONNECTION WIRING TO INDOOR-OUTDOOR TRANSMISSION F1 · F2, OUTDOOR-OUTDOOR TRANSMISSION F1 · F2. REFER TO INSTALLATION MANUAL ATTACHED TO THE CENTRAL REMOTE CONTROLLER, WHEN CONNECTING THE CENTRAL REMOTE CONTROLLER.
  - THIS WIRING DIAGRAM IS APPLIED ONLY TO THE OUTDOOR UNIT.

	L1-RED	L2-WHT	L3-BLK	N-BLU	
A1P	PRINTED CIRCUIT BOARD		K4R	MAGNETIC RELAY (M2F)	S1PH · 2PH PRESSURE SWITCH (HIGH)
A2P	PRINTED CIRCUIT BOARD (INV)		K5R	MAGNETIC RELAY (Y2S)	T1C DC CURRENT TRANSFORMER
BS1-5	PUSH BUTTON SWITCH (MODE · SET · NETWORK WIRING CHECK · RESET)		K6R	MAGNETIC RELAY (Y3S)	T1R TRANSFORMER (220V/22V)
C1R-4R	CAPACITOR		K7R	MAGNETIC RELAY (Y4S)	V1TR SOLID STATE RELAY
F2C	OVER CURRENT RELAY (M2C)		K8R	MAGNETIC RELAY (Y1S)	X1M TERMINAL STRIP
F1U · 2U	FUSE(250V, 10A)		K9R	MAGNETIC RELAY (Y1R)	Y1E EXPANSION VALVE (ELECTRONIC TYPE)
H1P-7P	LIGHT EMITTING DIODE (SERVICE MONITOR -ORANGE)(A1P)		K10R	MAGNETIC RELAY (J1HC)	Y1R 4 WAY VALVE
H1P-4P	LIGHT EMITTING DIODE (SERVICE MONITOR -RED)(A2P)		L1R	REACTOR	Y1S SOLENOID VALVE (HOTGAS EQUILIZING)
HAP	LIGHT EMITTING DIODE (SERVICE MONITOR -GREEN)(A1P)		M1C · 2C	MOTOR (COMPRESSOR)	Y2S SOLENOID VALVE (HOTGAS)
HAP	LIGHT EMITTING DIODE (SERVICE MONITOR -GREEN)(A2P)		M1F · 2F	MOTOR (FAN)	Y3S SOLENOID VALVE (INJECTION M1C)
HWL	PILOT LAMP (ALARM-WHITE)		Q1	POWER TRANSISTOR	Y4S SOLENOID VALVE (INJECTION M2C)
INV	INVERTER		Q1M · 2M	THERMO SWITCH (M1F, M2F)	Z1F-3F ROIZE FILTER
J1HC · 2HC	CRAPCASE HEATER		R1-4	RESISTOR	DM DIODE MODULE
K1M	MAGNETIC CONTACTOR (M1C)		R1T	THERMISTOR (F1R) (A2P)	F1S SURGE ABSORBER
K2M	MAGNETIC CONTACTOR (M2C)		R1T	THERMISTOR (A1R) (A1P)	PC POWER CIRCUIT
K1R · 2R	MAGNETIC RELAY (A2P)		R2T	THERMISTOR (COIL)	PM POWER MODULE
K1R	MAGNETIC RELAY (K2R)		R3-1T · 2T	THERMISTOR (DISCHARGE)	PRC PHASE REVERSAL DETECT CIRCUIT
K2R · 3R	MAGNETIC RELAY (M1F) (A1P)		R4T	THERMISTOR (SUCTION)	SD SAFETY DEVICES INPUT
			R5T	THERMISTOR (OIL)	
			R1V	VARISTOR	
			SENPH	PRESSURE SENSOR (HIGH)	OPTIONAL PARTS
			SENPL	PRESSURE SENSOR (LOW)	COOL/HEAT SELECTOR (KRC19-26)
			SS1	SELECTOR SWITCH (C/W SELECT)	SS1 SELECTOR SWITCH (FAN/COOL · HEAT)
			SS1	SELECTOR SWITCH (C/W SELECT)	SS2 SELECTOR SWITCH (COOL/HEAT)

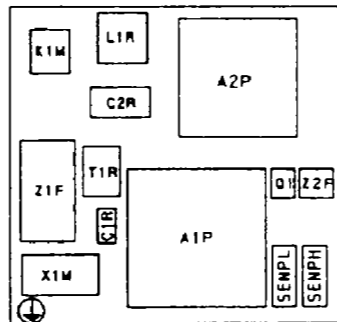
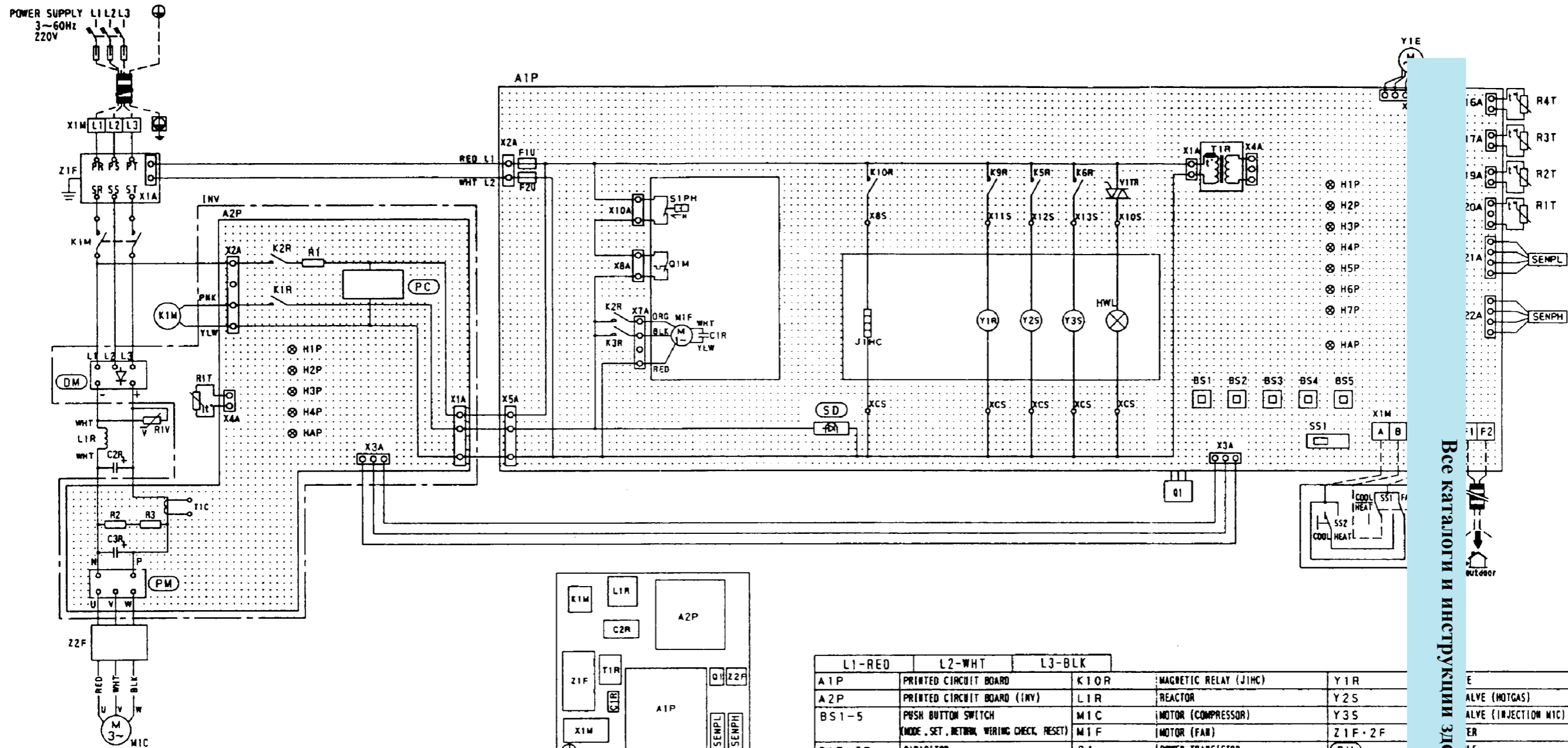

	L1-RED	L2-WHT	L3-BLK	
A1P	PRINTED CIRCUIT BOARD	K1OR	MAGNETIC RELAY (J1HC)	Y1R
A2P	PRINTED CIRCUIT BOARD (INV)	L1R	REACTOR	Y2S
BS1-5	PUSH BUTTON SWITCH (MODE, SET, RETURN, WIRING CHECK, RESET)	M1C	MOTOR (COMPRESSOR)	Y3S
C1R-3R	CAPACITOR	M1F	MOTOR (FAN)	Z1F-2F
F1U-2U	FUSE (250V, 10A)	Q1	POWER TRANSISTOR	DM
H1P-7P	LIGHT EMITTING DIODE (SERVICE MONITOR -ORANGE) (A1P)	Q1M	THERMO SWITCH (M1F)	PC
H1P-4P	LIGHT EMITTING DIODE (SERVICE MONITOR -RED) (A2P)	R1-3	RESISTOR	PM
H4P	LIGHT EMITTING DIODE (SERVICE MONITOR -GREEN) (A1P)	R1T	THERMISTOR (FIN) (A2P)	SD
H4P	LIGHT EMITTING DIODE (SERVICE MONITOR -GREEN) (A2P)	R1T	THERMISTOR (AIR) (A1P)	
H4P	LIGHT EMITTING DIODE (SERVICE MONITOR -GREEN) (A2P)	R2T	THERMISTOR (COIL)	
H4P	LIGHT EMITTING DIODE (SERVICE MONITOR -GREEN) (A2P)	R3T	THERMISTOR (DISCHARGE)	
H4P	LIGHT EMITTING DIODE (SERVICE MONITOR -GREEN) (A2P)	R4T	THERMISTOR (SUCTION)	
H4P	LIGHT EMITTING DIODE (SERVICE MONITOR -GREEN) (A2P)	R1V	VARISTOR	
H4P	LIGHT EMITTING DIODE (SERVICE MONITOR -GREEN) (A2P)	SEMPH	PRESSURE SENSOR (HIGH)	
H4P	LIGHT EMITTING DIODE (SERVICE MONITOR -GREEN) (A2P)	SEMPH	PRESSURE SENSOR (LOW)	
INV	INVERTER (A2P)	SS1	SELECTOR SWITCH (C/M SELECT)	
J1HC	CRANKCASE HEATER	S1PH	PRESSURE SWITCH (HIGH)	
K1M	MAGNETIC CONTACTOR (M1C)	T1C	DC CURRENT TRANSFORMER	
K1R-2R	MAGNETIC RELAY (A2P)	T1R	TRANSFORMER (220V/22V)	
K2R-3R	MAGNETIC RELAY (M1F)	V1TR	SOLID STATE RELAY	OPTIONAL
K5R	MAGNETIC RELAY (Y2S)	X1M	TERMINAL STRIP	COOL/HEAT
K6R	MAGNETIC RELAY (Y3S)	X1M	TERMINAL STRIP (A1P)	SS1
K9R	MAGNETIC RELAY (Y1R)	Y1E	EXPANSION VALVE (ELECTRONIC TYPE)	SS2

- NOTES)
- : TERMINAL   
 : CONNECTOR   
 : PROTECTIVE EARTH (SCREW)  
 : WIRE CLAMP   
 : FIELD WIRING
  - COLORS:  
 BLK:BLACK RED:RED WHT:WHITE YLW:YELLOW ORG:ORANGE PNK:PINK
  - REFER TO THE INSTALLATION MANUAL, FOR CONNECTION WIRING TO INDOOR-OUTDOOR TRANSMISSION F1 · F2, OUTDOOR-OUTDOOR TRANSMISSION F1 · F2, REFER TO INSTALLATION MANUAL ATTACHED TO THE CENTRAL REMOTE CONTROLLER, WHEN CONNECTING THE CENTRAL REMOTE CONTROLLER.
  - THIS WIRING DIAGRAM IS APPLIED ONLY TO THE OUTDOOR UNIT.

Все каталоги и инструкции здесь: <https://sp>

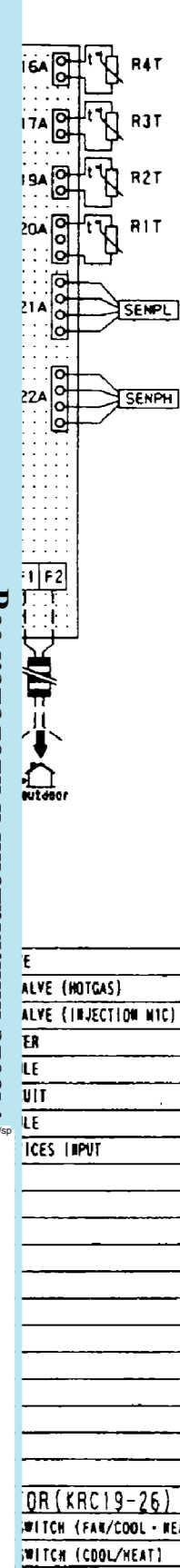

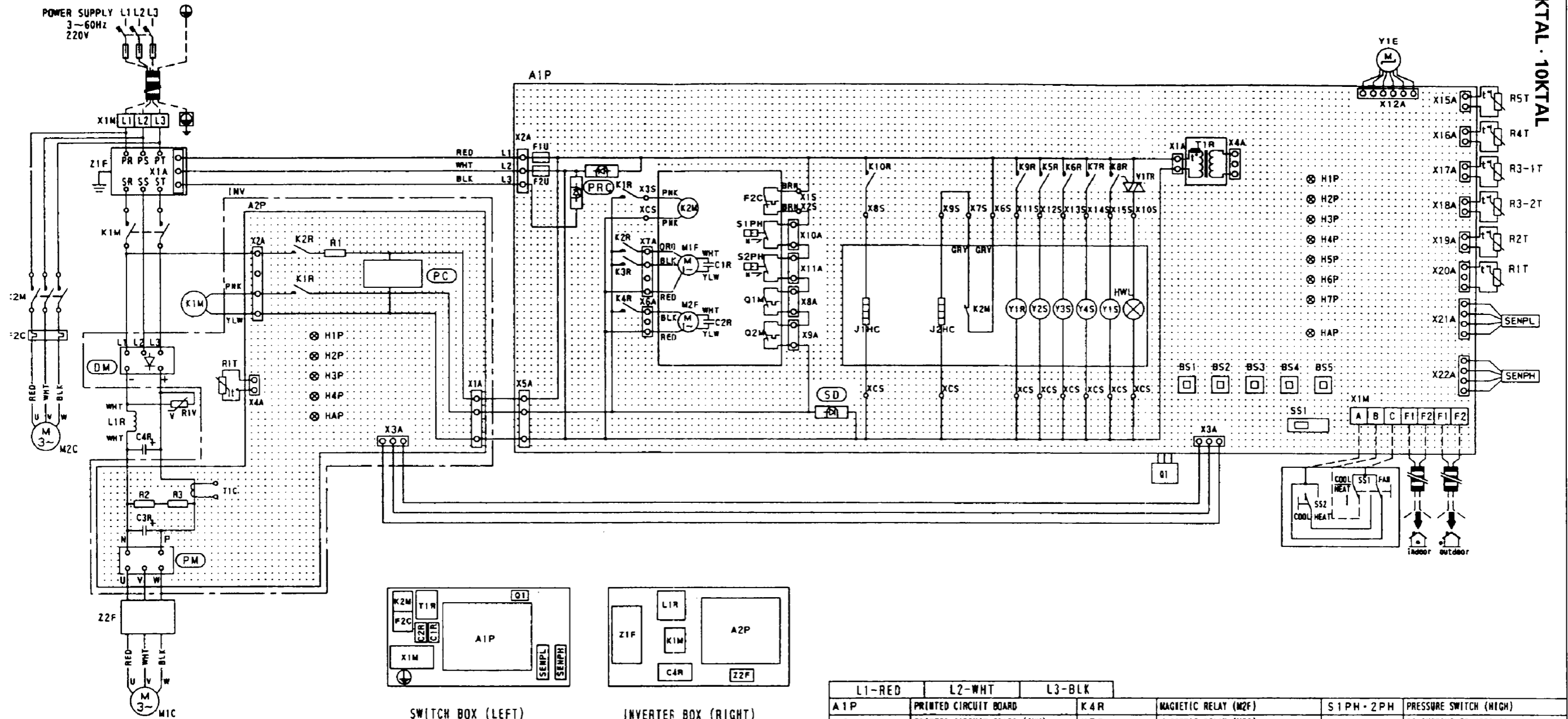

- NOTES)
- : TERMINAL    : CONNECTOR    : PROTECTIVE EARTH (SCREW)  
 : WIRE CLAMP    : FIELD WIRING
  - COLORS:  
 BLK:BLACK RED:RED WHT:WHITE YLW:YELLOW ORG:ORANGE BRN:BROWN PNK:PINK GRY:GREY
  - REFER TO THE INSTALLATION MANUAL, FOR CONNECTION WIRING TO INDOOR-OUTDOOR TRANSMISSION F1 · F2, OUTDOOR-OUTDOOR TRANSMISSION F1 · F2. REFER TO INSTALLATION MANUAL ATTACHED TO THE CENTRAL REMOTE CONTROLLER, WHEN CONNECTING THE CENTRAL REMOTE CONTROLLER.
  - THIS WIRING DIAGRAM IS APPLIED ONLY TO THE OUTDOOR UNIT.

	L1-RED	L2-WHT	L3-BLK		
A1P	PRINTED CIRCUIT BOARD		K4R	MAGNETIC RELAY (M2F)	S1PH · 2PH PRESSURE SWITCH (HIGH)
A2P	PRINTED CIRCUIT BOARD (INV)		K5R	MAGNETIC RELAY (Y2S)	T1C DC CURRENT TRANSFORMER
BS1-5	PUSH BUTTON SWITCH (MODE, SET, RETURN, WIRING CHECK, RESET)		K6R	MAGNETIC RELAY (Y3S)	T1R TRANSFORMER (220V/22V)
			K7R	MAGNETIC RELAY (Y4S)	V1TR SOLID STATE RELAY
C1R-4R	CAPACITOR		K8R	MAGNETIC RELAY (Y1S)	X1M TERMINAL STRIP
F2C	OVER CURRENT RELAY (M2C)		K9R	MAGNETIC RELAY (Y1R)	X1M TERMINAL STRIP (A1P)
F1U · 2U	FUSE (250V, 10A)		K10R	MAGNETIC RELAY (J1MC)	X1E EXPANSION VALVE (ELECTRONIC TYPE)
H1P-7P	LIGHT EMITTING DIODE (SERVICE MONITOR -ORANGE) (A1P)		L1R	REACTOR	Y1R 4 WAY VALVE
			M1C · 2C	MOTOR (COMPRESSOR)	Y1S SOLENOID VALVE (HOTGAS EQUILIZING)
H1P-4P	LIGHT EMITTING DIODE (SERVICE MONITOR -RED) (A2P)		M1F · 2F	MOTOR (FAN)	Y2S SOLENOID VALVE (HOTGAS)
			Q1	POWER TRANSISTOR	Y3S SOLENOID VALVE (INJECTION M1C)
HAP	LIGHT EMITTING DIODE (SERVICE MONITOR -GREEN) (A1P)		Q1M · 2M	THERMO SWITCH (M1F, M2F)	Y4S SOLENOID VALVE (INJECTION M2C)
			R1-3	RESISTOR	Z1F · 2F NOIZE FILTER
HAP	LIGHT EMITTING DIODE (SERVICE MONITOR -GREEN) (A2P)		R1T	THERMISTOR (FIN) (A2P)	DM DIODE MODULE
			R1T	THERMISTOR (AIR) (A1P)	PC POWER CIRCUIT
HWL	PILOT LAMP (ALARM-WHITE)		R2T	THERMISTOR (COIL)	PM POWER MODULE
INV	INVERTER (A2P)		R3-1T · 2T	THERMISTOR (DISCHARGE)	PRC PHASE REVERSAL DETECT CIRCUIT
J1HC · 2HC	CRANKCASE HEATER		R4T	THERMISTOR (SACTION)	SD SAFETY DEVICES INPUT
K1M	MAGNETIC CONTACTOR (M1C)		R5T	THERMISTOR (OIL)	
K2M	MAGNETIC CONTACTOR (M2C)		R1V	VARIABLE	OPTIONAL PARTS
K1R · 2R	MAGNETIC RELAY (A2P)		SENPB	PRESSURE SENSOR (HIGH)	COOL/HEAT SELECTOR (KRC19-26)
K1R	MAGNETIC RELAY (K2M)		SENPB	PRESSURE SENSOR (LOW)	SS1 SELECTOR SWITCH (FAN/COOL-HEAT)
K2R · 3R	MAGNETIC RELAY (M1F) (A1P)		SS1	SELECTOR SWITCH (C/H SELECT)	SS2 SELECTOR SWITCH (COOL/HEAT)

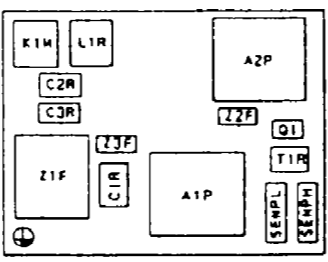
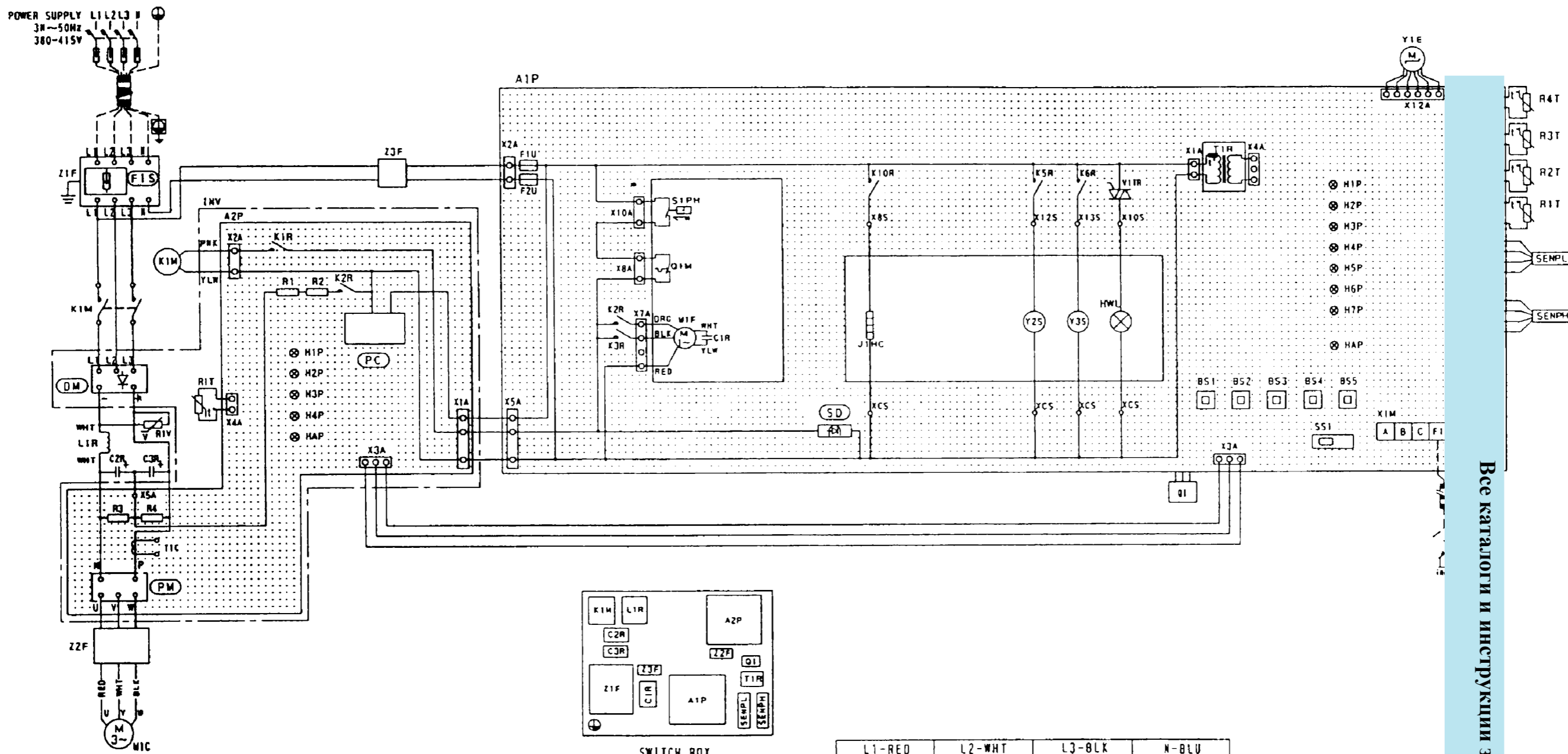

SWITCH BOX

NOTES)  
 1. [ ]: TERMINAL [ ]: CONNECTOR [ ]: PROTECTIVE EARTH (SCREEN)  
 [ ]: WIRE CLAMP [ ]: FIELD WIRING

2. COLORS:  
 BLK:BLACK RED:RED BUL:BLUE WHT:WHITE YLW:YELLOW ORG:ORANGE BRN:BROWN PNK:PINK GRN:GREEN GRY:GREY

3. REFER TO THE INSTALLATION MANUAL, FOR CONNECTION WIRING TO INDOOR-OUTDOOR TRANSMISSION F1 - F2, OUTDOOR-OUTDOOR TRANSMISSION F1 - F2. REFER TO INSTALLATION MANUAL ATTACHED TO THE CENTRAL REMOTE CONTROLLER, WHEN CONNECTING THE CENTRAL REMOTE CONTROLLER.

4. THIS WIRING DIAGRAM IS APPLIED ONLY TO THE OUTDOOR UNIT.

L1-RED	L2-WHT	L3-BLK	N-BLU
A1P	PRINTED CIRCUIT BOARD	K5R	MAGNETIC RELAY (Y2S)
A2P	PRINTED CIRCUIT BOARD (INV)	K6R	MAGNETIC RELAY (Y3S)
BS1-5	PUSH BUTTON SWITCH (MODE, SET, NETWORK WIRING CHECK, RESET)	K10R	MAGNETIC RELAY (J1HC)
C1R-3R	CAPACITOR	M1C	MOTOR (COMPRESSOR)
F1U-2U	FUSE(250V, 10A)	M1F	MOTOR (FAN)
H1P-7P	LIGHT EMITTING DIODE (SERVICE MONITOR -ORANGE)(A1P)	Q1	POWER TRANSISTOR
H1P-4P	LIGHT EMITTING DIODE (A1P) (SERVICE MONITOR -RED)(A2P)	Q1M	THERMO SWITCH (W1F)
HAP	LIGHT EMITTING DIODE (SERVICE MONITOR -GREEN)	R1-4	RESISTOR
HAP	LIGHT EMITTING DIODE (SERVICE MONITOR -GREEN)(A2P)	R1T	THERMISTOR (F1B) (A2P)
		R1R	THERMISTOR (A1R) (A1P)
		R2T	THERMISTOR (COIL)
		R3T	THERMISTOR (DISCHARGE)
		R4T	THERMISTOR (SUCTION)
HWL	PILOT LAMP (ALARM-WHITE)	R1V	VARIABLE RESISTOR
INV	INVERTER (A2P)	SEMPH	PRESSURE SENSOR (HIGH)
J1HC	CRANKCASE HEATER	SENPL	PRESSURE SENSOR (LOW)
K1M	MAGNETIC CONTACTOR (W1C)	SS1	SELECTOR SWITCH (C/M SELECT)
K1R-2R	MAGNETIC RELAY (A2P)	S1PH	PRESSURE SWITCH (HIGH)
K2R-3R	MAGNETIC RELAY (W1F)	T1C	DC CURRENT TRANSFORMER
		T1R	THERMISTOR
		V1TR	VARIABLE RESISTOR
		Y2S	MAGNETIC RELAY
		Y3S	MAGNETIC RELAY
		Y1E	ELECTRONIC TYPE
		Z1F-3F	INJECTION WIC
		Z2F	INPUT

Все каталоги и инструкции здесь: <https://sp>

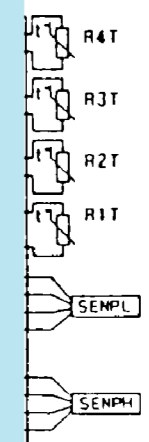

220-240V/22Y)
LAY
VE (ELECTRONIC TYPE)
(HOT GAS)
(INJECTION WIC)
INPUT



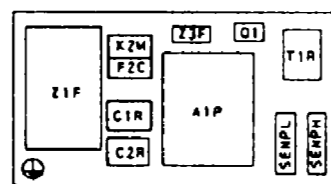
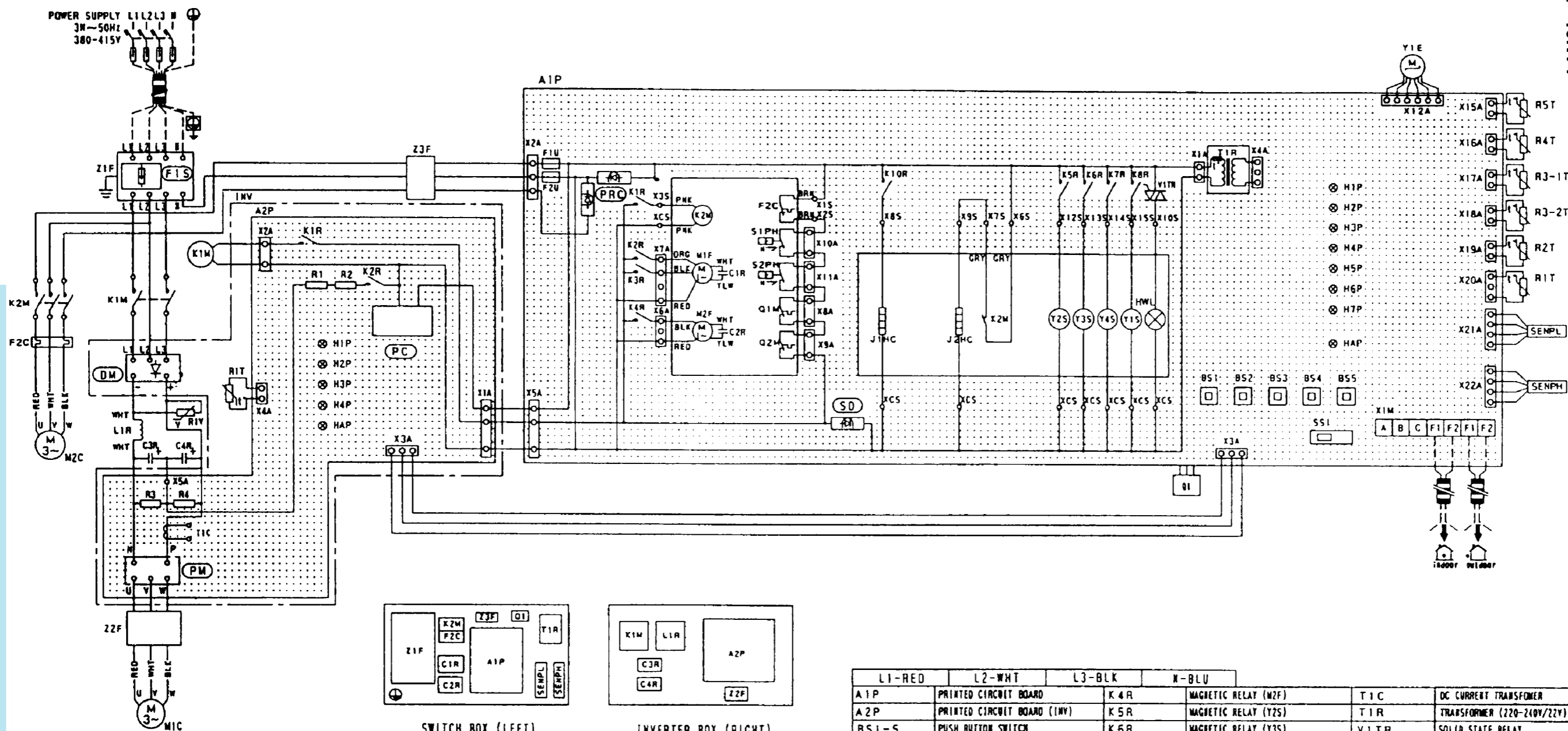

SWITCH BOX (LEFT)

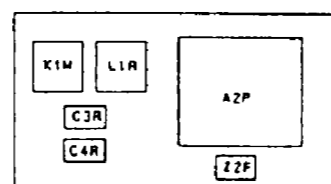

INVERTER BOX (RIGHT)

NOTES

- : TERMINAL    ○: CONNECTOR    ⊕: PROTECTIVE EARTH (SCREW)  
 ○: WIRE CLAMP    - - - : FIELD WIRING
- COLORS:  
 BLK: BLACK RED: RED BLU: BLUE WHT: WHITE YLW: YELLOW ORG: ORANGE BRN: BROWN PNK: PINK GRN: GREEN GRY: GREY
- REFER TO THE INSTALLATION MANUAL, FOR CONNECTION WIRING TO INDOOR-OUTDOOR TRANSMISSION F1 · F2, OUTDOOR-OUTDOOR TRANSMISSION F1 · F2, REFER TO INSTALLATION MANUAL ATTACHED TO THE CENTRAL REMOTE CONTROLLER, WHEN CONNECTING THE CENTRAL REMOTE CONTROLLER.
- THIS WIRING DIAGRAM IS APPLIED ONLY TO THE OUTDOOR UNIT.

	L1-RED	L2-WHT	L3-BLK	N-BLU		
A1P	PRINTED CIRCUIT BOARD		K4R	MAGNETIC RELAY (M2F)	T1C	DC CURRENT TRANSFORMER
A2P	PRINTED CIRCUIT BOARD (INV)		K5R	MAGNETIC RELAY (Y2S)	T1R	TRANSFORMER (220-240V/22Y)
BS1-5	PUSH BUTTON SWITCH (MODE, SET, RETURN, WIRING CHECK, RESET)		K6R	MAGNETIC RELAY (Y3S)	V1TR	SOLID STATE RELAY
C1R-4R	CAPACITOR		K7R	MAGNETIC RELAY (Y4S)	X1M	TERMINAL STRIP
F2C	OVER CURRENT RELAY (M2C)		K8R	MAGNETIC RELAY (Y1S)	Y1E	EXPANSION VALVE (ELECTRONIC TYPE)
F1U-2U	FUSE (250V, 10A)		K10R	MAGNETIC RELAY (J1MC)	Y1S	SOLENOID VALVE (HOTGAS EQUILIBRING)
H1P-7P	LIGHT EMITTING DIODE (SERVICE MONITOR -ORANGE)(A1P)		L1R	REACTOR	Y2S	SOLENOID VALVE (HOTGAS)
H1P-4P	LIGHT EMITTING DIODE (SERVICE MONITOR -RED)(A2P)		M1C-2C	MOTOR (COMPRESSOR)	Y3S	SOLENOID VALVE (INJECTION MIC)
HAP	LIGHT EMITTING DIODE (SERVICE MONITOR -GREEN)(A1P)		M1F-2F	MOTOR (FAN)	Y4S	SOLENOID VALVE (INJECTION M2C)
HAP	LIGHT EMITTING DIODE (SERVICE MONITOR -GREEN)(A2P)		Q1	POWER TRANSISTOR	Z1F-3F	NOISE FILTER
HWL	PILOT LAMP (ALARM-WHITE)		Q1M-2M	THERMO SWITCH (MIF, M2F)	Q1	DIODE MODULE
INV	INVERTER		R1-4	RESISTOR	(F1S)	SURGE ABSORBER
J1HC-2HC	CRANKCASE HEATER		R1T	THERMISTOR (FIN) (A2P)	(PC)	POWER CIRCUIT
K1M	MAGNETIC CONTACTOR (M1C)		R1T	THERMISTOR (AIR) (A1P)	(PM)	POWER MODULE
K2M	MAGNETIC CONTACTOR (M2C)		R2T	THERMISTOR (COIL)	(PRC)	PHASE REVERSAL DETECT CIRCUIT
K1R-2R	MAGNETIC RELAY (A2P)		R3-1T-2T	THERMISTOR (DISCHARGE)	(SD)	SAFETY DEVICES INPUT
K1R	MAGNETIC RELAY (K2M)		R4T	THERMISTOR (SUCTION)		
K2R-3R	MAGNETIC RELAY (M1F)(A1P)		R5T	THERMISTOR (OIL)		
			R1V	VARISTOR		
			SENPH	PRESSURE SENSOR (HIGH)		
			SENPL	PRESSURE SENSOR (LOW)		
			SSI	SELECTOR SWITCH (C/M SELECT)		
			S1PH-2PH	PRESSURE SWITCH (HIGH)		

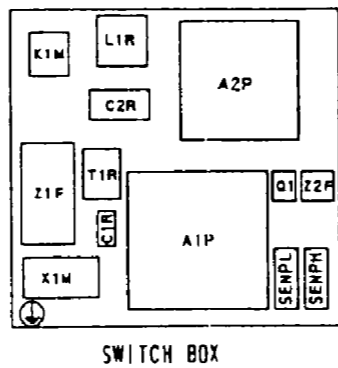
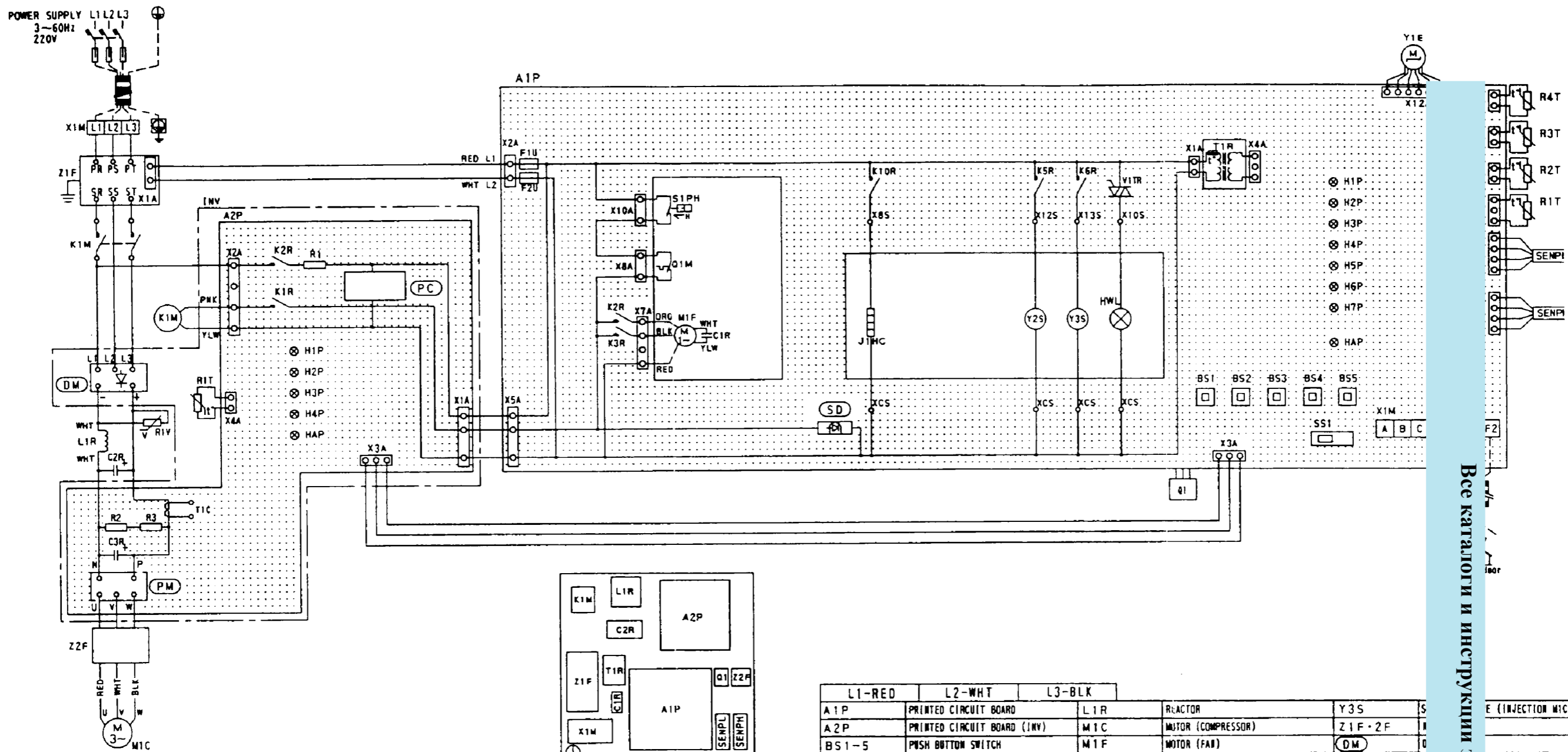

NOTES)

1. [Terminal symbol]: TERMINAL [Connector symbol]: CONNECTOR [Protective Earth symbol]: PROTECTIVE EARTH (SCREW)  
[Wire Clamp symbol]: WIRE CLAMP [Field Wiring symbol]: FIELD WIRING
2. COLORS:  
BLK:BLACK RED:RED WHT:WHITE YLW:YELLOW ORG:ORANGE PNK:PINK
3. REFER TO THE INSTALLATION MANUAL, FOR CONNECTION WIRING TO INDOOR-OUTDOOR TRANSMISSION F1 · F2, OUTDOOR-OUTDOOR TRANSMISSION F1 · F2, REFER TO INSTALLATION MANUAL ATTACHED TO THE CENTRAL REMOTE CONTROLLER, WHEN CONNECTING THE CENTRAL REMOTE CONTROLLER.
4. THIS WIRING DIAGRAM IS APPLIED ONLY TO THE OUTDOOR UNIT.

	L1-RED	L2-WHT	L3-BLK		
A1P	PRINTED CIRCUIT BOARD	L1R	REACTOR	Y3S	S
A2P	PRINTED CIRCUIT BOARD (INV)	M1C	MOTOR (COMPRESSOR)	Z1F-2F	M
BS1-5	PUSH BUTTON SWITCH (MODE, SET, RETURN, WIRING CHECK, RESET)	M1F	MOTOR (FAN)	DM	D
C1R-3R	CAPACITOR	Q1M	POWER TRANSISTOR	PC	P
F1U · 2U	FUSE (250V, 10A)	R1-3	RESISTOR	PM	P
H1P-7P	LIGHT EMITTING DIODE (SERVICE MONITOR -ORANGE) (A1P)	R1T	THERMISTOR (FIN) (A2P)	SD	S
H1P-4P	LIGHT EMITTING DIODE (SERVICE MONITOR -RED) (A2P)	R1T	THERMISTOR (AIR) (A1P)		
HAP	LIGHT EMITTING DIODE (SERVICE MONITOR -GREEN) (A1P)	R2T	THERMISTOR (COIL)		
HAP	LIGHT EMITTING DIODE (SERVICE MONITOR -GREEN) (A2P)	R3T	THERMISTOR (DISCHARGE)		
HWL	PILOT LAMP (ALARM-WHITE)	R4T	THERMISTOR (SUCTION)		
INV	INVERTER (A2P)	R1V	VARIABLE RESISTOR		
J1HC	CRANKCASE HEATER	SENPH	PRESSURE SENSOR (HIGH)		
K1M	MAGNETIC CONTACTOR (M1C)	SENPL	PRESSURE SENSOR (LOW)		
K1R-2R	MAGNETIC RELAY (A2P)	SS1	SELECTOR SWITCH (C/M SELECT)		
K2R-3R	MAGNETIC RELAY (M1F)	S1PH	PRESSURE SWITCH (HIGH)		
K5R	MAGNETIC RELAY (Y2S)	T1C	DC CURRENT TRANSFORMER		
K6R	MAGNETIC RELAY (Y3S)	T1R	TRANSFORMER (220V/22V)		
K1OR	MAGNETIC RELAY (J1HC)	V1TR	SOLID STATE RELAY		
		X1M	TERMINAL STRIP (A1P)		
		X1M	TERMINAL STRIP (A2P)		
		Y1E	EXPANSION VALVE (ELECTRONIC TYPE)		
		Y2S	SELENOID VALVE (HOTGAS)		

Все каталоги и инструкции здесь: <https://sp>

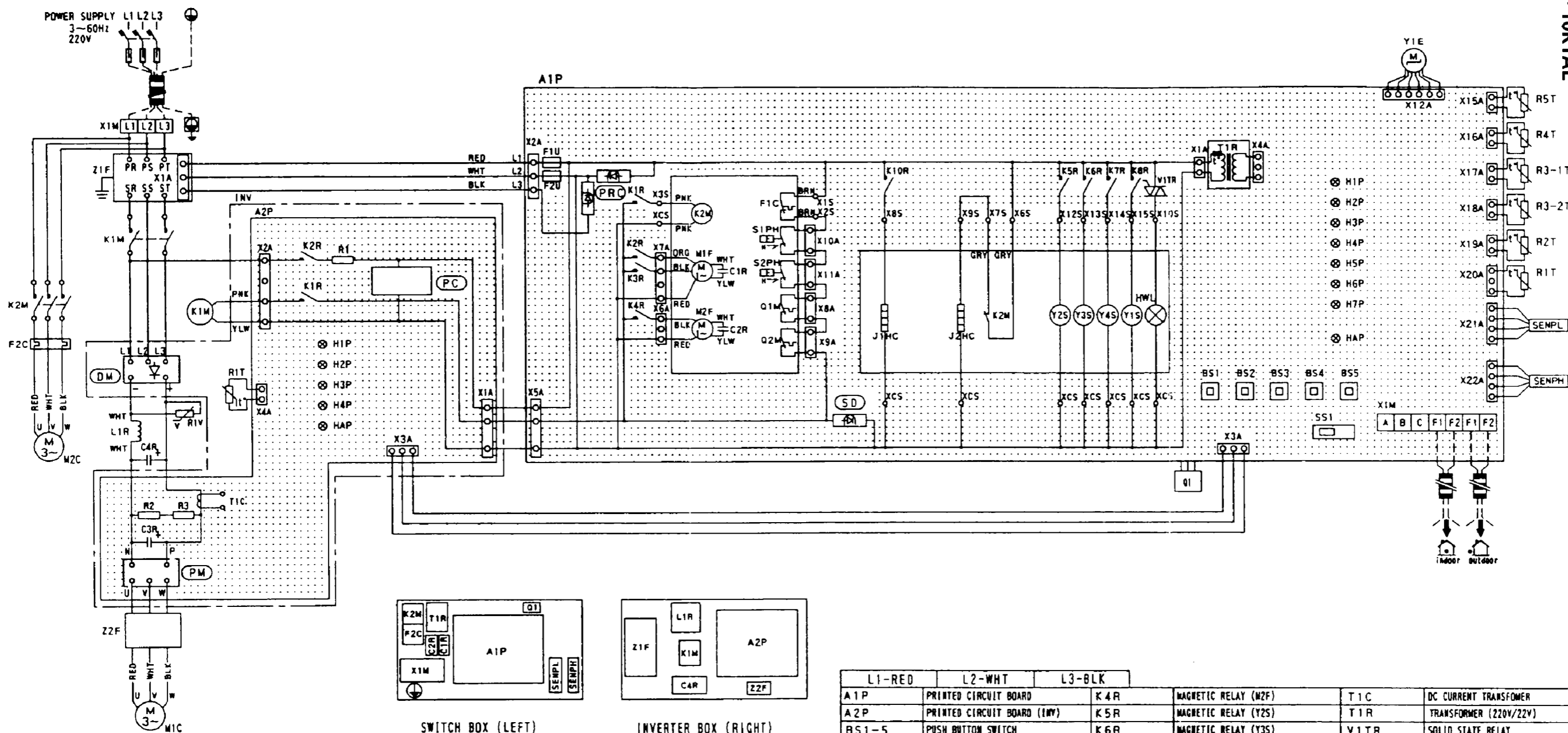

NOTES

- : TERMINAL    ○ : CONNECTOR    ⊕ : PROTECTIVE EARTH (SCREW)

○ : WIRE CLAMP    - - - : FIELD WIRING
- COLORS:

BLK:BLACK RED:RED WHT:WHITE YLW:YELLOW ORG:ORANGE BRN:BROWN PNK:PINK GRY:GREY
- REFER TO THE INSTALLATION MANUAL, FOR CONNECTION WIRING TO INDOOR-OUTDOOR TRANSMISSION F1 · F2, OUTDOOR-OUTDOOR TRANSMISSION F1 · F2, REFER TO INSTALLATION MANUAL ATTACHED TO THE CENTRAL REMOTE CONTROLLER, WHEN CONNECTING THE CENTRAL REMOTE CONTROLLER,
- THIS WIRING DIAGRAM IS APPLIED ONLY TO THE OUTDOOR UNIT.

L1-RED	L2-WHT	L3-BLK			
A1P	PRINTED CIRCUIT BOARD	K4R	MAGNETIC RELAY (M2F)	T1C	DC CURRENT TRANSFORMER
A2P	PRINTED CIRCUIT BOARD (INV)	K5R	MAGNETIC RELAY (Y2S)	T1R	TRANSFORMER (220V/22V)
BS1-5	PUSH BUTTON SWITCH (MODE, SET, RETURN, WIRING CHECK, RESET)	K6R	MAGNETIC RELAY (Y3S)	V1TR	SOLID STATE RELAY
C1R-4R	CAPACITOR	K7R	MAGNETIC RELAY (Y4S)	X1M	TERMINAL STRIP
F1C	OVER CURRENT RELAY (M2C)	K8R	MAGNETIC RELAY (Y1S)	X1M	TERMINAL STRIP (A1P)
F1U-2U	FUSE (250V, 10A)	K10R	MAGNETIC RELAY (J1NC)	Y1E	EXPANSION VALVE (ELECTRONIC TYPE)
H1P-7P	LIGHT EMITTING DIODE (SERVICE MONITOR -ORANGE)(A1P)	L1R	REACTOR	Y1S	SOLENOID VALVE (HOTGAS EQUILIZING)
H1P-4P	LIGHT EMITTING DIODE (SERVICE MONITOR -RED)(A2P)	M1C-2C	MOTOR (COMPRESSOR)	Y2S	SOLENOID VALVE (HOTGAS)
HAP	LIGHT EMITTING DIODE (SERVICE MONITOR -GREEN)(A1P)	M1F-2F	MOTOR (FAN)	Y3S	SOLENOID VALVE (INJECTION MIC)
HAP	LIGHT EMITTING DIODE (SERVICE MONITOR -GREEN)(A2P)	Q1	POWER TRANSISTOR	Y4S	SOLENOID VALVE (INJECTION M2C)
HWL	PILDT LAMP (ALARM-WHITE)	Q1M-2M	THERMO SWITCH (M1F, M2F)	Z1F-2F	BOIIZE FILTER
INV	INVERTER (A2P)	R1-3	RESISTOR	DM	DIODE MODULE
J1HC-2HC	CRANKCASE HEATER	R1T	THERMISTOR (F1W) (A2P)	PC	POWER CIRCUIT
K1M	MAGNETIC CONTACTOR (M1C)	R2T	THERMISTOR (A1R) (A1P)	PM	POWER MODULE
K2M	MAGNETIC CONTACTOR (M2C)	R3-1T-2T	THERMISTOR (DISCHARGE)	PRC	PHASE REVERSAL DETECT CIRCUIT
K1R-2R	MAGNETIC RELAY (A2P)	R4T	THERMISTOR (SUCTIOW)	SD	SAFETY DEVICES INPUT
K1R	MAGNETIC RELAY (K2M)	R5T	THERMISTOR (OIL)		
K2R-3R	MAGNETIC RELAY (M1F) (A1P)	R1V	VARISTOR		
		SEMPH	PRESSURE SENSOR (HIGH)		
		SEMPL	PRESSURE SENSOR (LOW)		
		SS1	SELECTOR SWITCH (C/M SELECT)		
		S1PH-2PH	PRESSURE SWITCH (HIGH)		

● BL2K

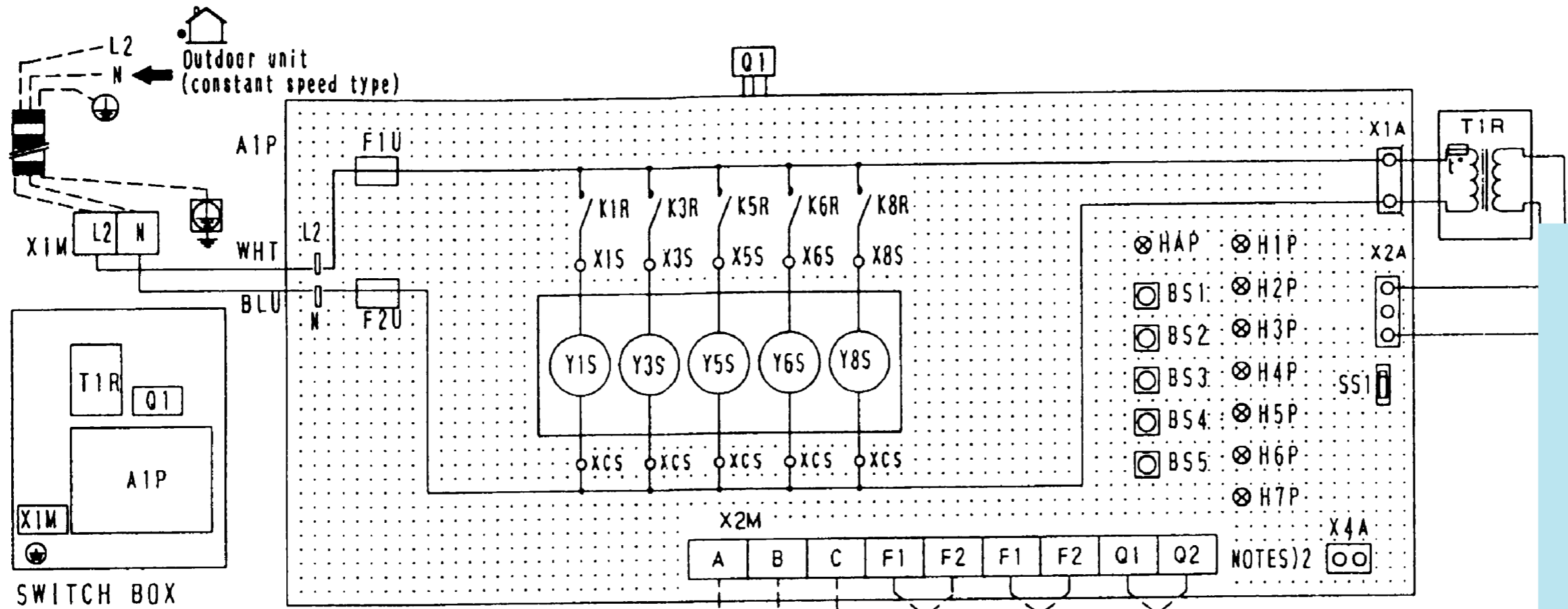

- NOTES)
1. : TERMINAL : CONNECTOR  
 : PROTECTIVE EARTH (SCREW)  
 : WIRE CLAMP : FIELD WIRING
  2. WHEN USING THE EXTERNAL CONTROL ADAPTOR FOR OUTDOOR UNIT, REFER TO THE INSTALLATION MANUAL.
  3. REFER TO THE INSTALLATION MANUAL, FOR CONNECTION WIRING TO INDOOR-OUTDOOR TRANSMISSION F1 · F2, OUTDOOR-OUTDOOR TRANSMISSION F1 · F2, FUNCTION UNIT · OUTDOOR-OUTDOOR TRANSMISSION Q1 · Q2.
  4. THIS WIRING DIAGRAM IS APPLIED ONLY TO THE FUNCTION UNIT.

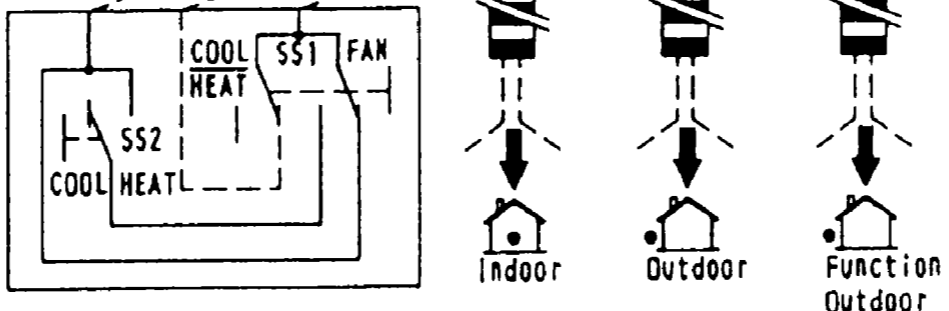

A1P	PRINTED CIRCUIT BOARD	HAP	LIGHT EMITTING DIODE (SERVICE MONITOR -GREEN)	Y3S	SOLENOID VALVE (PRESSURIZING PIPE)
BS1-5	PUSH BUTTON SWITCH (MODE, SET, RETURN, WIRING CHECK, RESET)	Q1	POWER TRANSISTOR	Y5S-6S	SOLENOID VALVE (BYPASS)
FIU-2U	FUSE (250V, 5A)	SS1	SELECTOR SWITCH (C/H SELECT)	Y8S	SOLENOID VALVE (HOT WATER CIRCULATING)
K1R	MAGNETIC RELAY (Y1S)	T1R	TRANSFORMER (220V-240V/22V)	OPTIONAL PARTS	
K3R	MAGNETIC RELAY (Y3S)	X4A	CONNECTOR ADAPTOR	CONTROL ADAPTOR (OUTDOOR UNIT)	
K5R	MAGNETIC RELAY (Y5S)	X1M-2M	TERMINAL STRIP	COOL/HEAT SELECTOR (RC19-26)	
K6R	MAGNETIC RELAY (Y6S)	Y1S	SOLENOID VALVE (GAS PIPE)	COOL/HEAT SELECTOR (COOL/HEAT)	
K8R	MAGNETIC RELAY (Y8S)			SS1	SELECTOR SWITCH (COOL/HEAT)
H1P-7P	LIGHT EMITTING DIODE (SERVICE MONITOR -ORANGE)			SS2	SELECTOR SWITCH (COOL/HEAT)

Все каталоги и инструкции здесь: <https://sp>

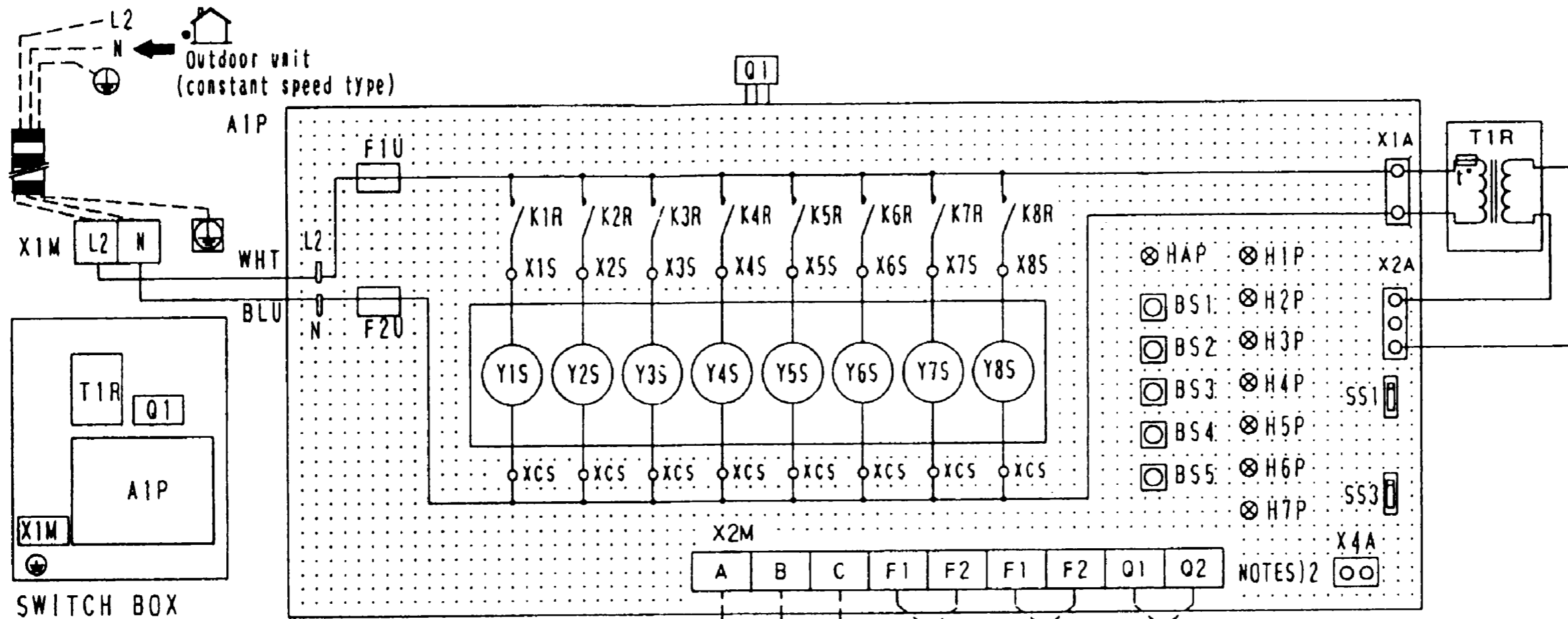

NOTES)

1. : TERMINAL : CONNECTOR  
 : PROTECTIVE EARTH (SCREW)  
 : WIRE CLAMP - - - : FIELD WIRING
2. WHEN USING THE EXTERNAL CONTROL ADAPTOR FOR OUTDOOR UNIT, REFER TO THE INSTALLATION MANUAL.
3. REFER TO THE INSTALLATION MANUAL, FOR CONNECTION WIRING TO INDOOR-OUTDOOR TRANSMISSION F1 · F2, OUTDOOR-OUTDOOR TRANSMISSION F1 · F2, FUNCTION UNIT · OUTDOOR-OUTDOOR TRANSMISSION Q1 · Q2.
4. THIS WIRING DIAGRAM IS APPLIED ONLY TO THE FUNCTION UNIT.

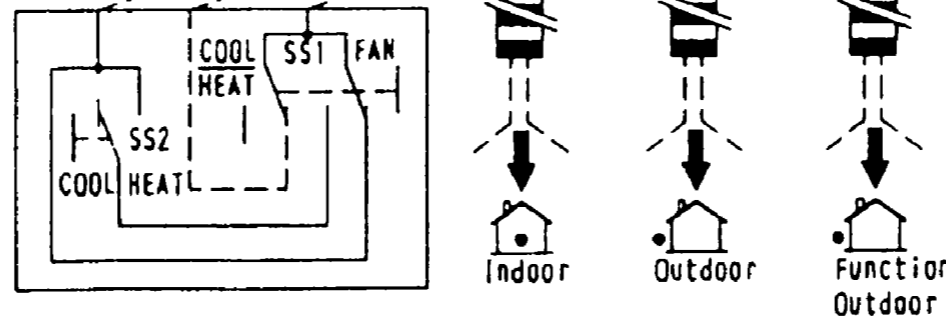

AIP	PRINTED CIRCUIT BOARD	H1P-7P	LIGHT EMITTING DIODE (SERVICE MONITOR -ORANGE)	Y3S-4S	SOLENOID VALVE (PRESSURE EQUALIZING PIPE)
BS1-5	PUSH BUTTON SWITCH (MODE, SET, RETURN, WIRING CHECK, RESET)	HAP	LIGHT EMITTING DIODE (SERVICE MONITOR -GREEN)	Y5S-7S	SOLENOID VALVE (FOR BYPASS)
FIU-2U	FUSE(250V, 5A)	Q1	POWER TRANSISTOR	Y8S	SOLENOID VALVE (HOT GAS EQUALIZING)
K1R	MAGNETIC RELAY(Y1S)	SS1	SELECTOR SWITCH(C/H SELECT)	OPTIONAL PARTS	
K2R	MAGNETIC RELAY(Y2S)	SS3	SELECTOR SWITCH (NUMBER OF OUTDOOR UNITS)		
K3R	MAGNETIC RELAY(Y3S)	T1R	TRANSFORMER(220-240/22V)	X 4 A	CONNECTOR (EXTERNAL CONTROL ADAPTOR FOR OUTDOOR UNIT)
K4R	MAGNETIC RELAY(Y4S)	X1M-2M	TERMINAL STRIP	COOL/HEAT SELECTOR (KRC19-26)	
K5R	MAGNETIC RELAY(Y5S)	Y1S-2S	SOLENOID VALVE (GAS PIPE)	SS 1	SELECTOR SWITCH (FAN/COOL · HEAT)
K6R	MAGNETIC RELAY(Y6S)			SS 2	SELECTOR SWITCH (COOL/HEAT)
K7R	MAGNETIC RELAY(Y7S)				
K8R	MAGNETIC RELAY(Y8S)				

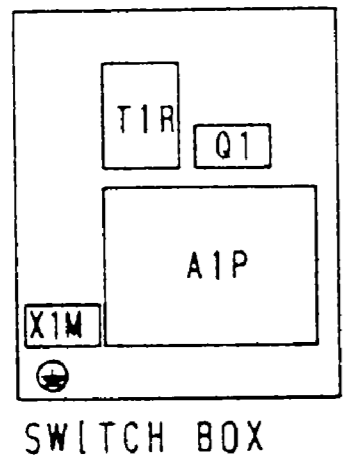
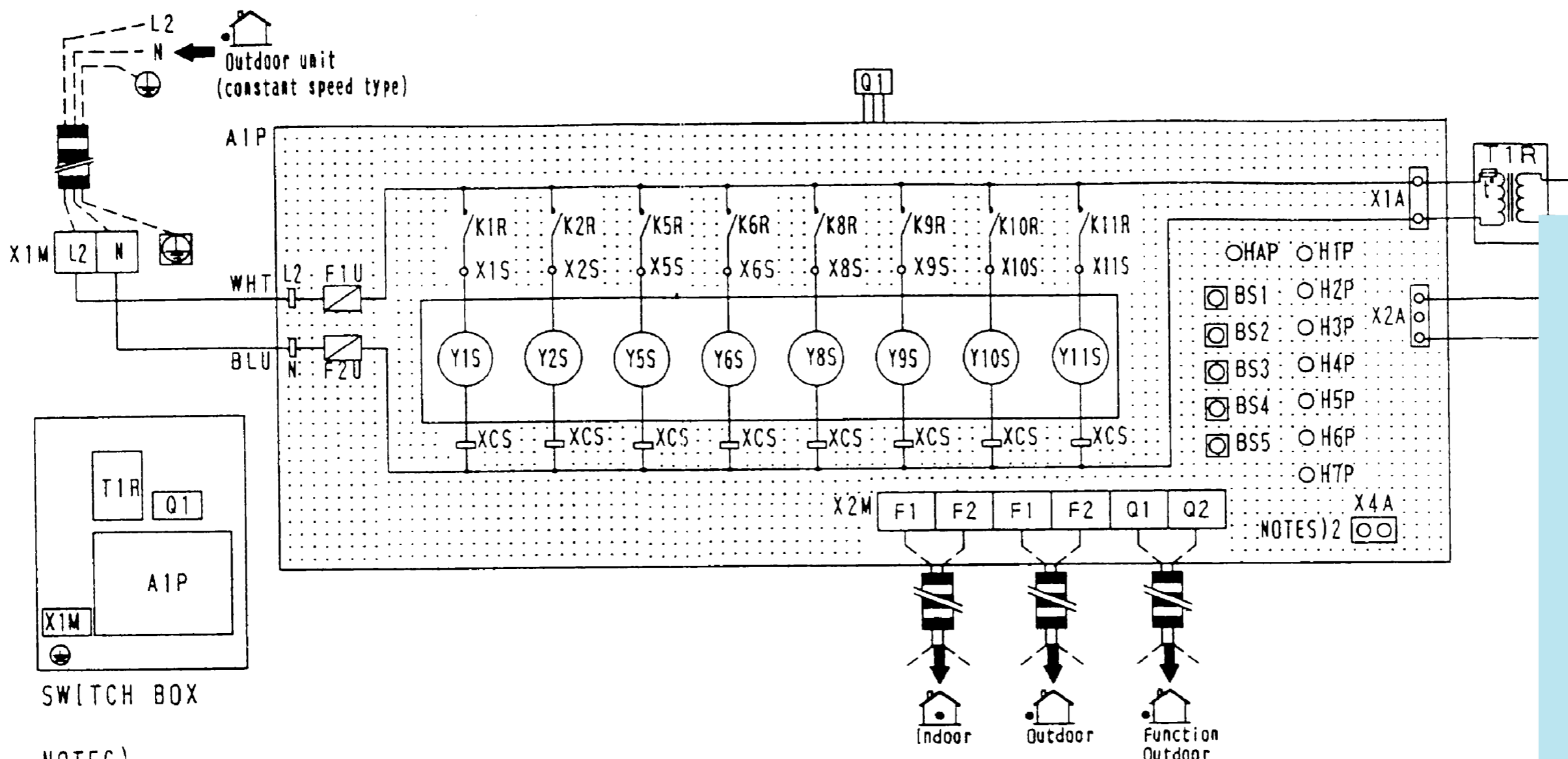

NOTES)

1. : TERMINAL : CONNECTOR  
 : PROTECTIVE EARTH (SCREW)  
 : WIRE CLAMP : FIELD WIRING
2. WHEN USING THE EXTERNAL CONTROL ADAPTOR FOR OUTDOOR UNIT, REFER TO THE INSTALLATION MANUAL.
3. REFER TO THE INSTALLATION MANUAL, FOR CONNECTION WIRING TO INDOOR-OUTDOOR TRANSMISSION F1 · F2, OUTDOOR-OUTDOOR TRANSMISSION F1 · F2, FUNCTION UNIT · OUTDOOR-OUTDOOR TRANSMISSION Q1 · Q2.
4. THIS WIRING DIAGRAM IS APPLIED ONLY TO THE FUNCTION UNIT.

AIP	PRINTED CIRCUIT BOARD	H1P-7P	LIGHT EMITTING DIODE (SERVICE MONITOR -ORANGE)	Y5S	SOLENOID VALVE (DISCHARGE)
BS1-5	PUSH BUTTON SWITCH (MODE, SET, RETURN, WIRING CHECK, RESET)			Y6S	SOLENOID VALVE (DISCHARGE)
F1U-2U	FUSE(250V, 5A)	HAP	LIGHT EMITTING DIODE (SERVICE MONITOR -GREEN)	Y8S	SOLENOID VALVE (DISCHARGE)
K1R	MAGNETIC RELAY(Y1S)	Q1	POWER TRANSISTOR	Y9S	SOLENOID VALVE (DISCHARGE)
K2R	MAGNETIC RELAY(Y2S)	T1R	TRANSFORMER(220-240/22V)	Y10S	SOLENOID VALVE (DISCHARGE)
K5R	MAGNETIC RELAY(Y5S)	X1M-2M	TERMINAL STRIP	Y11S	SOLENOID VALVE (DISCHARGE)
K6R	MAGNETIC RELAY(Y6S)				
K8R	MAGNETIC RELAY(Y8S)	Y1S	SOLENOID VALVE (PRESS, EQUALIZING PIPE FOR BYPASS)		OPTIONAL PARTS
K9R	MAGNETIC RELAY(Y9S)				X 4 A CONNECTOR ADAPTOR
K10R	MAGNETIC RELAY(Y10S)	Y2S	SOLENOID VALVE (GAS PIPE—PRESS, EQUALIZING PIPE )		
K11R	MAGNETIC RELAY(Y11S)				

Все каталоги и инструкции здесь: <https://sp>

EQUALIZING 1)
EQUALIZING 2)
25S EQUALIZING)
35S EQUALIZING PIPE)
45S EQUALIZING PIPE)
55S EQUALIZING)
65S EQUALIZING PIPE)
75S EQUALIZING)
85S EQUALIZING PIPE)
95S EQUALIZING)
105S EQUALIZING PIPE)
115S EQUALIZING)
125S EQUALIZING PIPE)
135S EQUALIZING)
145S EQUALIZING PIPE)
155S EQUALIZING)
165S EQUALIZING PIPE)
175S EQUALIZING)
185S EQUALIZING PIPE)
195S EQUALIZING)
205S EQUALIZING PIPE)
215S EQUALIZING)
225S EQUALIZING PIPE)
235S EQUALIZING)
245S EQUALIZING PIPE)
255S EQUALIZING)
265S EQUALIZING PIPE)
275S EQUALIZING)
285S EQUALIZING PIPE)
295S EQUALIZING)
305S EQUALIZING PIPE)
315S EQUALIZING)
325S EQUALIZING PIPE)
335S EQUALIZING)
345S EQUALIZING PIPE)
355S EQUALIZING)
365S EQUALIZING PIPE)
375S EQUALIZING)
385S EQUALIZING PIPE)
395S EQUALIZING)
405S EQUALIZING PIPE)
415S EQUALIZING)
425S EQUALIZING PIPE)
435S EQUALIZING)
445S EQUALIZING PIPE)
455S EQUALIZING)
465S EQUALIZING PIPE)
475S EQUALIZING)
485S EQUALIZING PIPE)
495S EQUALIZING)
505S EQUALIZING PIPE)
515S EQUALIZING)
525S EQUALIZING PIPE)
535S EQUALIZING)
545S EQUALIZING PIPE)
555S EQUALIZING)
565S EQUALIZING PIPE)
575S EQUALIZING)
585S EQUALIZING PIPE)
595S EQUALIZING)
605S EQUALIZING PIPE)
615S EQUALIZING)
625S EQUALIZING PIPE)
635S EQUALIZING)
645S EQUALIZING PIPE)
655S EQUALIZING)
665S EQUALIZING PIPE)
675S EQUALIZING)
685S EQUALIZING PIPE)
695S EQUALIZING)
705S EQUALIZING PIPE)
715S EQUALIZING)
725S EQUALIZING PIPE)
735S EQUALIZING)
745S EQUALIZING PIPE)
755S EQUALIZING)
765S EQUALIZING PIPE)
775S EQUALIZING)
785S EQUALIZING PIPE)
795S EQUALIZING)
805S EQUALIZING PIPE)
815S EQUALIZING)
825S EQUALIZING PIPE)
835S EQUALIZING)
845S EQUALIZING PIPE)
855S EQUALIZING)
865S EQUALIZING PIPE)
875S EQUALIZING)
885S EQUALIZING PIPE)
895S EQUALIZING)
905S EQUALIZING PIPE)
915S EQUALIZING)
925S EQUALIZING PIPE)
935S EQUALIZING)
945S EQUALIZING PIPE)
955S EQUALIZING)
965S EQUALIZING PIPE)
975S EQUALIZING)
985S EQUALIZING PIPE)
995S EQUALIZING)
1005S EQUALIZING PIPE)

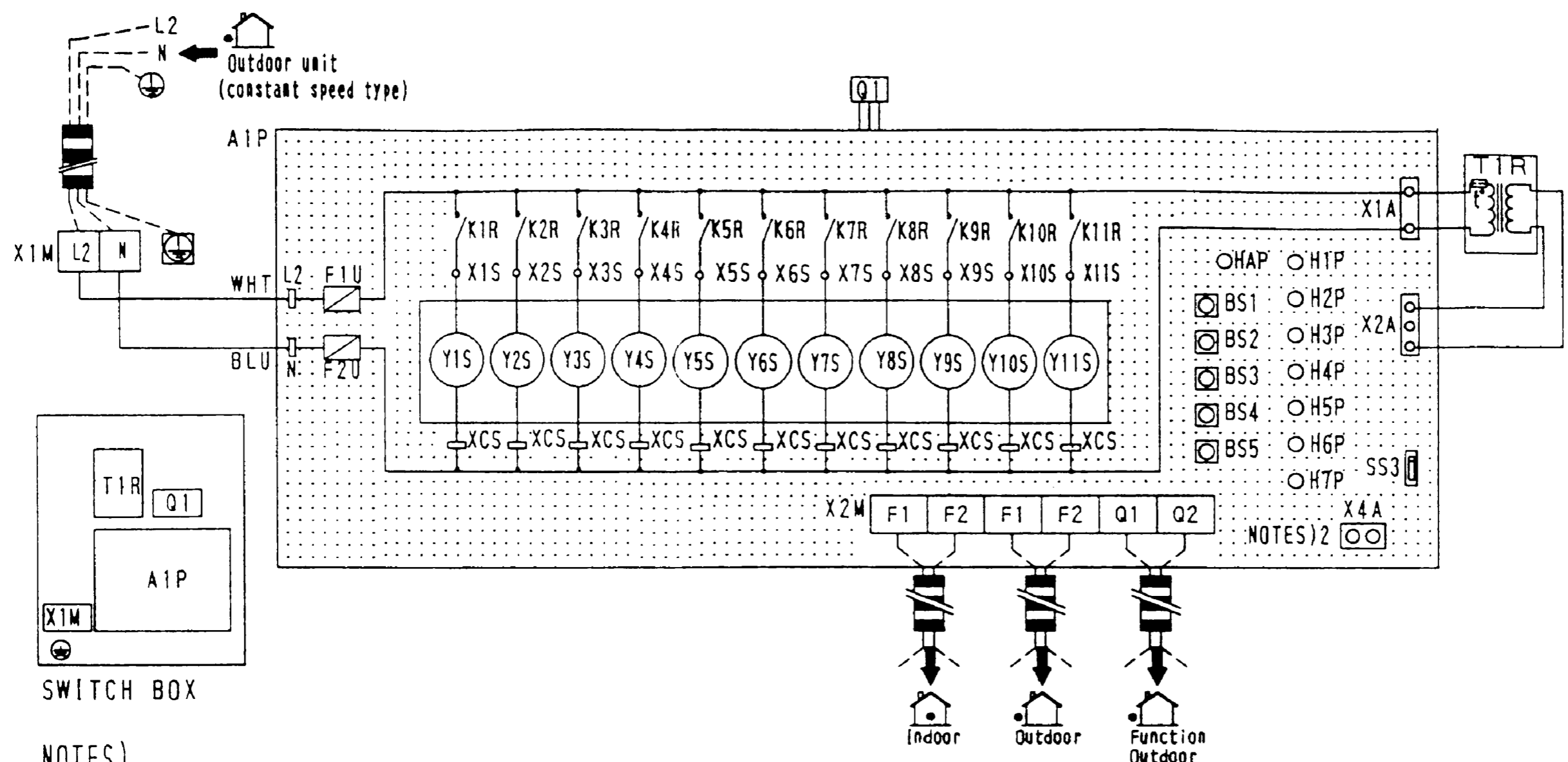

NOTES)

- : TERMINAL    ○○ : CONNECTOR

⊕ : PROTECTIVE EARTH (SCREW)

—○— : WIRE CLAMP    - - - : FIELD WIRING
- WHEN USING THE EXTERNAL CONTROL ADAPTOR FOR OUTDOOR UNIT, REFER TO THE INSTALLATION MANUAL.
- REFER TO THE INSTALLATION MANUAL, FOR CONNECTION WIRING TO INDOOR-OUTDOOR TRANSMISSION F1 · F2, OUTDOOR-OUTDOOR TRANSMISSION F1 · F2, FUNCTION UNIT · OUTDOOR-OUTDOOR TRANSMISSION Q1 · Q2.
- THIS WIRING DIAGRAM IS APPLIED ONLY TO THE FUNCTION UNIT.

AIP	PRINTED CIRCUIT BOARD	H1P-7P	LIGHT EMITTING DIODE (SERVICE MONITOR -ORANGE)	Y4S	SOLENOID VALVE (GAS PIPE-PRESS. EQUALIZING PIPE 2)
BS1-5	PUSH BUTTON SWITCH (MODE, SET, RETURN, WIRING CHECK, RESET)	HAP	LIGHT EMITTING DIODE (SERVICE MONITOR -GREEN)	Y5S	SOLENOID VALVE (OIL EQUALIZING 1)
F1U-2U	FUSE(250V, 5A)			Y6S	SOLENOID VALVE (OIL EQUALIZING 2)
K1R	MAGNETIC RELAY(Y1S)	Q1	POWER TRANSISTOR	Y7S	SOLENOID VALVE (OIL EQUALIZING 3)
K2R	MAGNETIC RELAY(Y2S)	SS3	SELECTOR SWITCH (NUMBER OF OUTDOOR UNITS)	Y8S	SOLENOID VALVE (HOT GAS EQUALIZING)
K3R	MAGNETIC RELAY(Y3S)	T1R	TRANSFORMER(220-240/22V)	Y9S	SOLENOID VALVE (DISCHARGE PIPE-PRESS. EQUALIZING PIPE)
K4R	MAGNETIC RELAY(Y4S)	X1M-2M	TERMINAL STRIP	Y10S	SOLENOID VALVE (SECTION PIPE-PRESS. EQUALIZING PIPE)
K5R	MAGNETIC RELAY(Y5S)	Y1S	SOLENOID VALVE (PRESS. EQUALIZING PIPE 1 FOR BYPASS)	Y11S	SOLENOID VALVE (PRESS. EQUALIZING)
K6R	MAGNETIC RELAY(Y6S)	Y2S	SOLENOID VALVE (GAS PIPE-PRESS. EQUALIZING PIPE 1)	OPTIONAL PARTS	
K7R	MAGNETIC RELAY(Y7S)	Y3S	SOLENOID VALVE (PRESS. EQUALIZING PIPE 2 FOR BYPASS)	X4A	CONNECTOR (EXTERNAL CONTROL ADAPTOR FOR OUTDOOR UNIT)
K8R	MAGNETIC RELAY(Y8S)				
K9R	MAGNETIC RELAY(Y9S)				
K10R	MAGNETIC RELAY(Y10S)				
K11R	MAGNETIC RELAY(Y11S)				

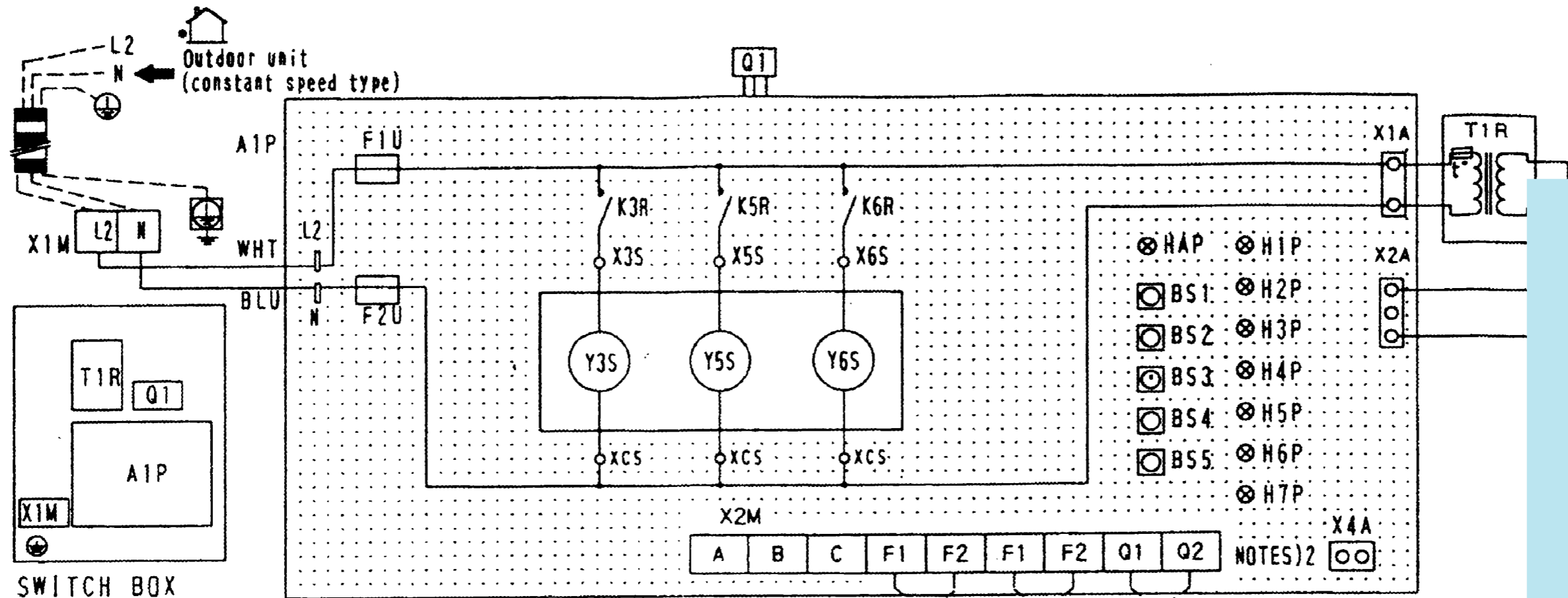

NOTES)

1. : TERMINAL    : CONNECTOR  
 : PROTECTIVE EARTH (SCREW)  
 : WIRE CLAMP    : FIELD WIRING
2. COLORS:  
 BLU: BLUE WHT: WHITE
3. WHEN USING THE EXTERNAL CONTROL ADAPTOR FOR OUTDOOR UNIT, REFER TO THE INSTALLATION MANUAL.
4. REFER TO THE INSTALLATION MANUAL, FOR CONNECTION WIRING TO INDOOR-OUTDOOR TRANSMISSION F1 · F2, OUTDOOR-OUTDOOR TRANSMISSION F1 · F2, FUNCTION UNIT - OUTDOOR-OUTDOOR TRANSMISSION Q1 · Q2.
5. THIS WIRING DIAGRAM IS APPLIED ONLY TO THE FUNCTION UNIT.

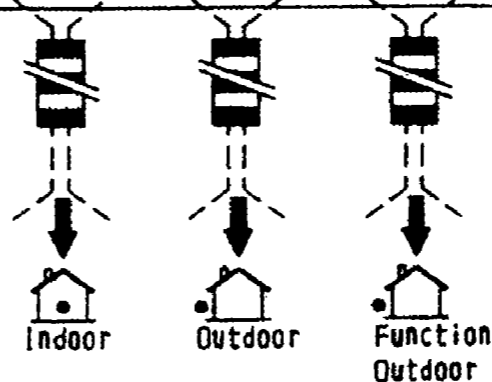

A1P	PRINTED CIRCUIT BOARD	HAP	LIGHT EMITTING DIODE (SERVICE MONITOR -GREEN)	Y5S·6S	SOLENOID VALVE (FOR	
BS1-5	PUSH BUTTON SWITCH (MODE, SET, RETURN, WIRING CHECK, RESET)	Q1	POWER TRANSISTOR			
F1U·2U	FUSE (250V, 5A)	T1R	TRANSFORMER (220V-240V/22V)			
K3R	MAGNETIC RELAY (Y3S)	X1M·2M	TERMINAL STRIP	OPTIONAL PARTS		
K5R	MAGNETIC RELAY (Y5S)			X 4 A	CONNECTOR (EXTERNAL C	ADAPTOR FOR OUT
K6R	MAGNETIC RELAY (Y6S)					
H1P-7P	LIGHT EMITTING DIODE (SERVICE MONITOR -ORANGE)	Y3S	SOLENOID VALVE (PRESSURE EQUALIZING PIPE)			

Все каталоги и инструкции здесь: <https://sp>



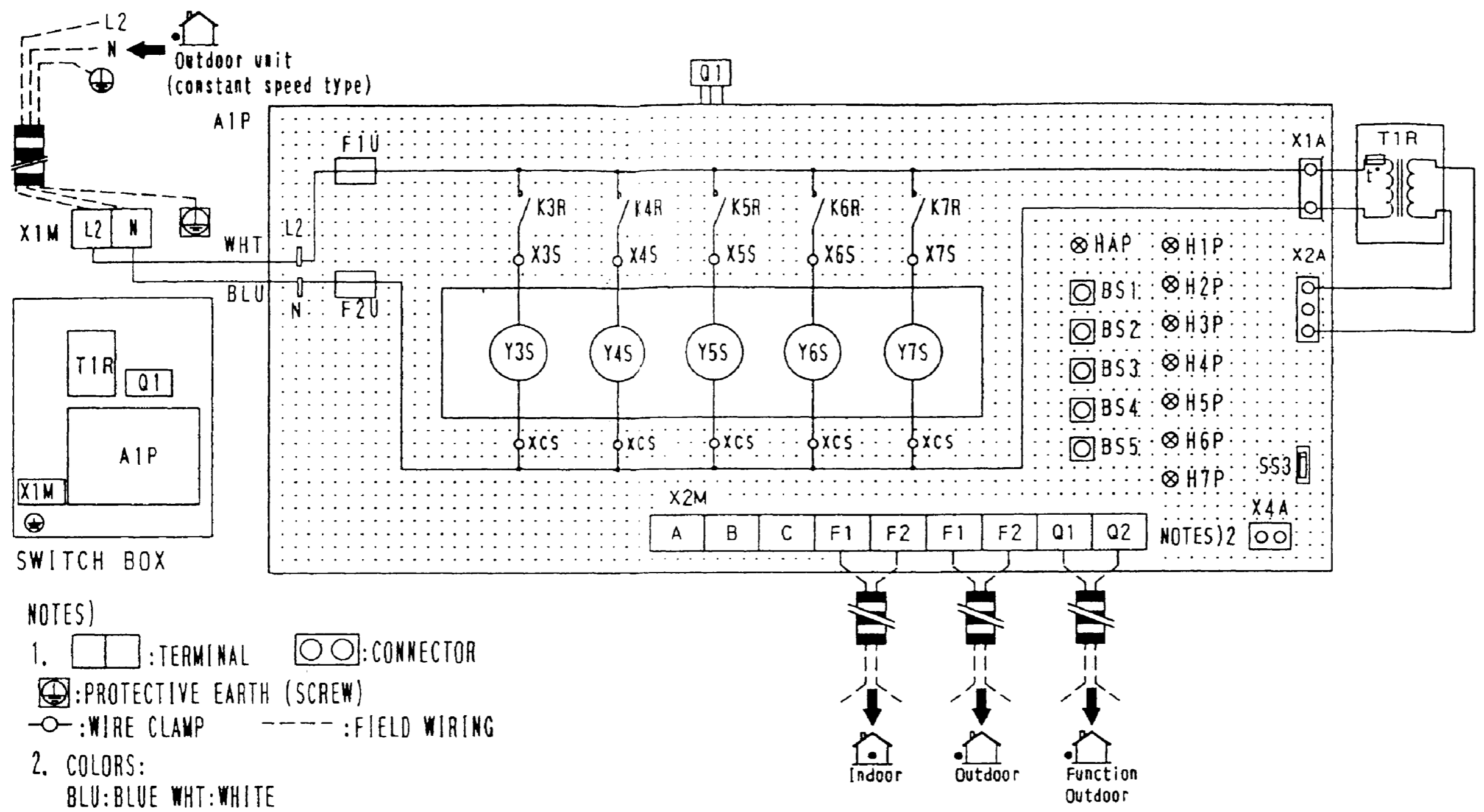

NOTES)

1. : TERMINAL    : CONNECTOR
- : PROTECTIVE EARTH (SCREW)
- : WIRE CLAMP    : FIELD WIRING

2. COLORS:  
BLU: BLUE WHT: WHITE
3. WHEN USING THE EXTERNAL CONTROL ADAPTOR FOR OUTDOOR UNIT, REFER TO THE INSTALLATION MANUAL.
4. REFER TO THE INSTALLATION MANUAL, FOR CONNECTION WIRING TO INDOOR-OUTDOOR TRANSMISSION F1 · F2, OUTDOOR-OUTDOOR TRANSMISSION F1 · F2, FUNCTION UNIT · OUTDOOR-OUTDOOR TRANSMISSION Q1 · Q2.
5. THIS WIRING DIAGRAM IS APPLIED ONLY TO THE FUNCTION UNIT.

A1P	PRINTED CIRCUIT BOARD	H1P-7P	LIGHT EMITTING DIODE (SERVICE MONITOR -ORANGE)	X1M-2M	TERMINAL STRIP
BS1-5	PUSH BUTTON SWITCH (MODE, SET, RETURN, WIRING CHECK, RESET)	HAP	LIGHT EMITTING DIODE (SERVICE MONITOR -GREEN)	Y3S-4S	SOLENOID VALVE (PRESSURE EQUALIZING PIPE)
F1U-2U	FUSE (250V, 5A)	Q1	POWER TRANSISTOR	Y5S-7S	SOLENOID VALVE (FOR BYPASS)
K3R	MAGNETIC RELAY (Y3S)	SS3	SELECTOR SWITCH (NUMBER OF OUTDOOR UNITS)	OPTIONAL PARTS	
K4R	MAGNETIC RELAY (Y4S)			X 4 A	CONNECTOR (EXTERNAL CONTROL ADAPTOR FOR OUTDOOR UNIT)
K5R	MAGNETIC RELAY (Y5S)				
K6R	MAGNETIC RELAY (Y6S)				
K7R	MAGNETIC RELAY (Y7S)	T1R	TRANSFORMER (220-240/22V)		

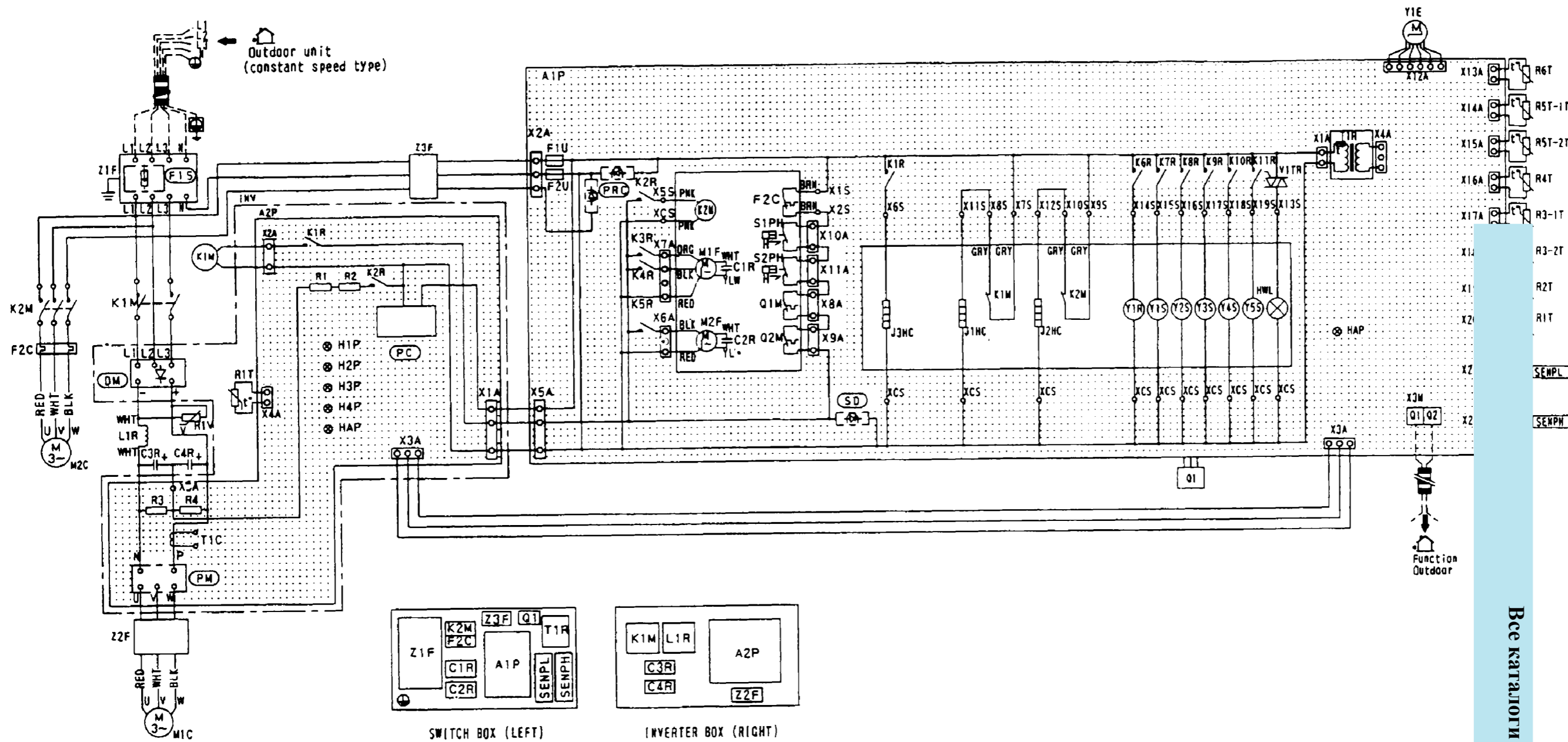

RXY8K-10K

(4) PLUS Series Inverter type (Heat pump)

Все каталоги и инструкции здесь: <https://sp>

- NOTES)
1. [Terminal symbol]: TERMINAL [Connector symbol]: CONNECTOR [Screw symbol]: PROTECTIVE EARTH (SCREW)  
[Wire clamp symbol]: WIRE CLAMP [Field wiring symbol]: FIELD WIRING
  2. COLORS:  
BLK:BLACK RED:RED BLU:BLUE WHT:WHITE YLW:YELLOW ORG:ORANGE BRN:BROWN PNK:PINK GRY:GREY
  3. REFER TO THE INSTALLATION MANUAL, FOR CONNECTION WIRING TO FUNCTION UNIT - OUTDOOR-OUTDOOR TRANSMISSION Q1 - Q2.
  4. THIS WIRING DIAGRAM IS APPLIED ONLY TO THE OUTDOOR UNIT.

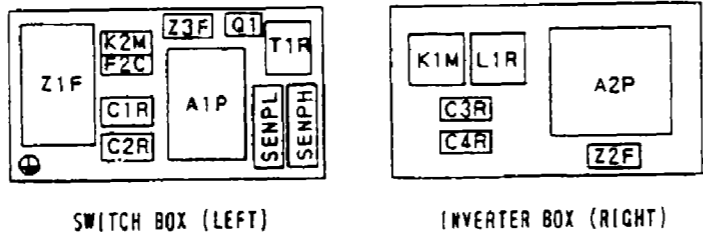

	L1-RED	L2-WHT	L3-BLK	N-BLU	
A1P	PRINTED CIRCUIT BOARD	K5R	MAGNETIC RELAY (M2F)	S1PH·2PH	PH (HIGH)
A2P	PRINTED CIRCUIT BOARD (INV)	K6R	MAGNETIC RELAY (Y1R)	SEMPH	PH (HIGH)
C1R-4R	CAPACITOR	K7R	MAGNETIC RELAY (Y1S)	SEMPL	PH (LOW)
F1U·2U	FUSE(250V, 10A)	K8R	MAGNETIC RELAY (Y2S)	T1C	DC TRANSFORMER
F2C	OVER CURRENT RELAY (M2C)	K9R	MAGNETIC RELAY (Y3S)	T1R	TR (20-240V/22V)
H1P-4P	LIGHT EMITTING DIODE (SERVICE MONITOR -RED) (A1P)	K10R	MAGNETIC RELAY (Y4S)	V1TR	SO (LAMP)
HAP	LIGHT EMITTING DIODE (SERVICE MONITOR -GREEN) (A1P)	K11R	MAGNETIC RELAY (Y5S)	X3M	TE (ELECTRONIC TYPE)
HAP	LIGHT EMITTING DIODE (SERVICE MONITOR -GREEN) (A2P)	L1R	REACTOR	Y1E	ER (HOTGAS)
HAP	LIGHT EMITTING DIODE (SERVICE MONITOR -GREEN) (A2P)	M1C·2C	MOTOR (COMPRESSOR)	Y1R	A (INJECTION M1C)
HWL	PILOT LAMP (ALARM-WHITE)	M1F·2F	MOTOR (FAN)	Y1S	SO (INJECTION M2C)
INV	INVERTER	Q1	POWER TRANSISTOR	Y2S	SO (HOTGAS EQUILIZING)
J1HC·2HC	CRAMCASE HEATER	Q1M·2M	THERMO SWITCH (M1F, M2F)	Y3S	SO (OIL CONTROL)
J3HC	CRAMCASE HEATER	R1-4	RESISTOR (A2P)	Y4S	SO
K1M	MAGNETIC CONTACTOR (M1C)	R1T	THERMISTOR (FIN) (A2P)	Y5S	SO
K1R·2R	MAGNETIC RELAY (A2P)	R1T	THERMISTOR (AIR) (A1P)	Z1F-3F	NO
K1R	MAGNETIC RELAY (J3HC) (A1P)	R1V	VARIATOR	(DM)	BI
K2M	MAGNETIC CONTACTOR (M2C)	R2T	THERMISTOR (COIL)	(F1S)	SW
K2R	MAGNETIC RELAY (K2M) (A1P)	R3-1T·2T	THERMISTOR (DISCHARGE)	(PC)	PO
K3R·4R	MAGNETIC RELAY (M1F)	R4T	THERMISTOR (SUCTION)	(PM)	PO
		R5-1T·2T	THERMISTOR (OIL)	(PRC)	PH
		R6T	THERMISTOR (HEADER)	(SD)	SA

RNY8K-10K

POWER SUPPLY  
 Y1: 3N~50Hz  
 380-415V  
 YAL: 3N~60Hz  
 380V

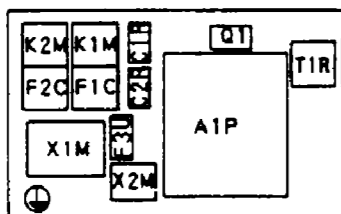
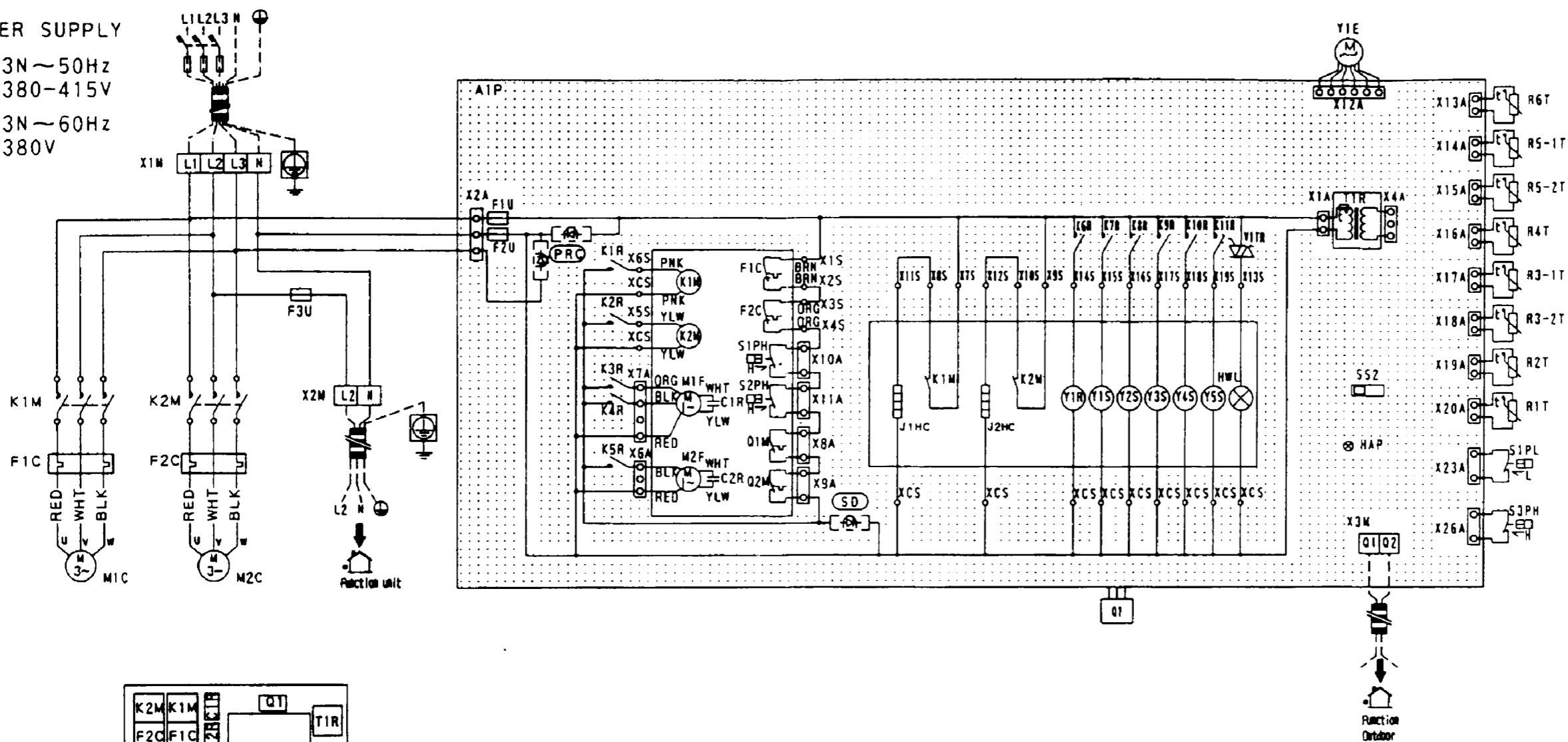

SWITCH BOX

NOTES)

1. [ ]: TERMINAL [ ]: CONNECTOR [ ]: PROTECTIVE EARTH (SCREW)  
 ○: WIRE CLAMP ---: FIELD WIRING
2. COLORS:  
 BLK: BLACK RED: RED BLU: BLUE WHT: WHITE YLW: YELLOW ORG: ORANGE BRN: BROWN PNK: PINK GRY: GREY
3. REFER TO THE INSTALLATION MANUAL, FOR CONNECTION WIRING TO FUNCTION UNIT • OUTDOOR-OUTDOOR TRANSMISSION Q1 • Q2.
4. THIS WIRING DIAGRAM IS APPLIED ONLY TO THE OUTDOOR UNIT.

L1-RED	L2-WHT	L3-BLK	N-BLU
A1P	PRINTED CIRCUIT BOARD	K7R	MAGNETIC RELAY (Y1S)
C1R-2R	CAPACITOR	K8R	MAGNETIC RELAY (Y2S)
F1C-2C	OVER CURRENT RELAY (M1C-2C)	K9R	MAGNETIC RELAY (Y3S)
F1U-2U	FUSE(250V, 10A)	K10R	MAGNETIC RELAY (Y4S)
F3U	FUSE(250V, 5A)	K11R	MAGNETIC RELAY (Y5S)
HAP	LIGHT EMITTING DIODE (SERVICE MONITOR -GREEN)	M1C-2C	MOTOR (COMPRESSOR)
HWL	PILOT LAMP (ALARM-WHITE)	M1F-2F	MOTOR (FAN)
J1HC-2HC	CRANKCASE HEATER	Q1	POWER TRANSISTOR
K1M	MAGNETIC CONTACTOR (M1C)	Q1M-2M	THERMO SWITCH (M1F, M2F)
K1R	MAGNETIC RELAY (K1M)	R1T	THERMISTOR (AIR)
K2M	MAGNETIC CONTACTOR (M2C)	R2T	THERMISTOR (COIL)
K2R	MAGNETIC RELAY (K2M)	R3-1T-2T	THERMISTOR (DISCHARGE)
K3R-4R	MAGNETIC RELAY (M1F)	R4T	THERMISTOR (SMCT(OH))
K5R	MAGNETIC RELAY (M2F)	R5-1T-2T	THERMISTOR (OIL)
K6R	MAGNETIC RELAY (Y1R)	R6T	THERMISTOR (HEADER)
		S1-S2PH	PRESSURE SWITCH (HIGH)
		S1PL	PRESSURE SWITCH (LOW CONTROL)
		S3PH	PRESSURE SWITCH (HIGH CONTROL)
		SS2	SYSTEM CHANGEOVER SWITCH
		T1R	TRANSFORMER (220-240V/22V)
		V1TR	SOLID STATE RELAY
		X1M-3M	TERMINAL STRIP
		Y1E	EXPANSION VALVE (ELECTRONIC TYPE)
		Y1R	4 WAY VALVE
		Y1S	SOLENOID VALVE (HOTGAS EQUILIZING)
		Y2S	SOLENOID VALVE (HOTGAS)
		Y3S	SOLENOID VALVE (INJECTION M1C)
		Y4S	SOLENOID VALVE (INJECTION M2C)
		Y5S	SOLENOID VALVE (OIL SUCTION)
		PRC	PHASE REVERSAL DETECT CIRCUIT
		SD	SAFETY DEVICES INPUT

(6) PLUS Series Inverter type (Cooling only)

RX8K-10K

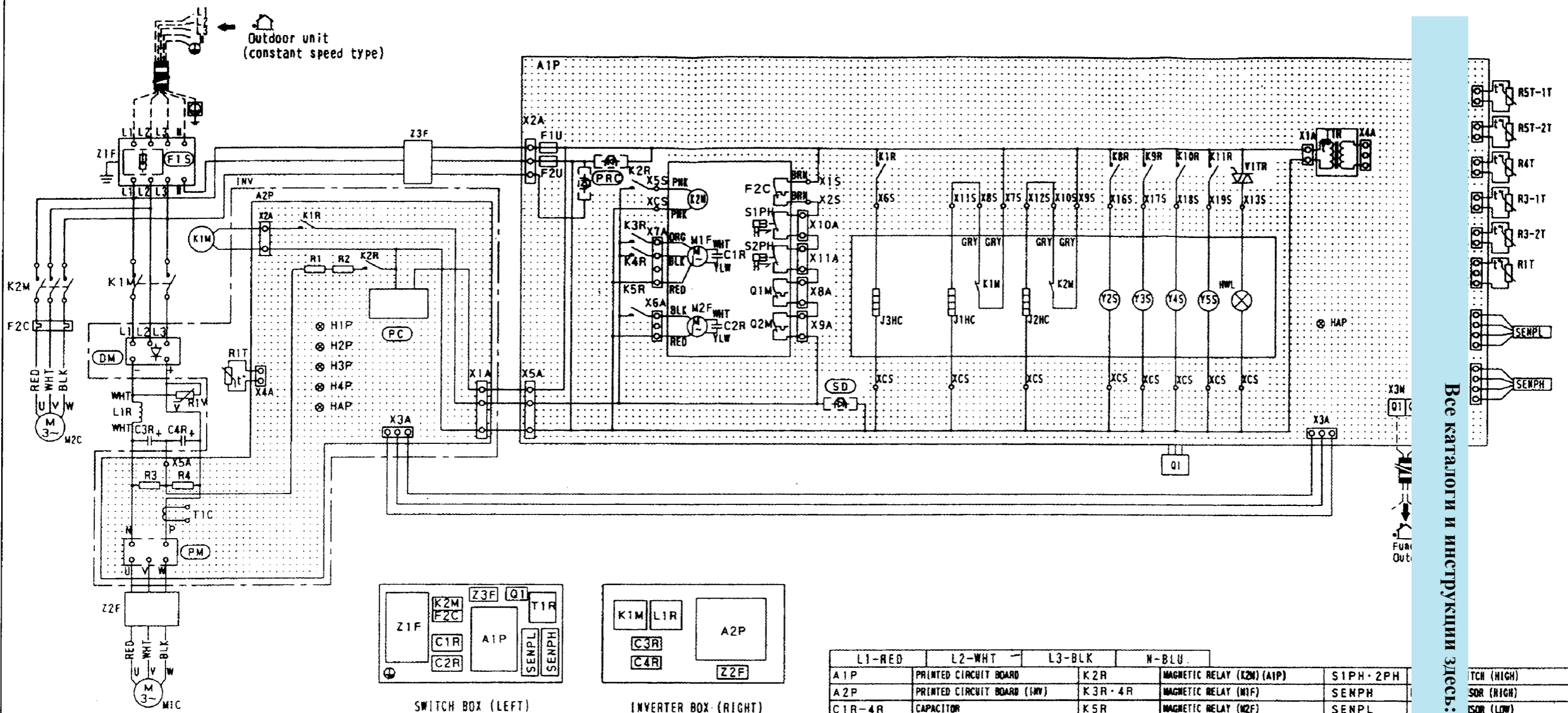

Все каталоги и инструкции здесь: <https://sp>

L1-RED	L2-WHT	L3-BLK	N-BLU	
A1P	PRINTED CIRCUIT BOARD	K2R	MAGNETIC RELAY (K2M) (A1P)	S1PH-2PH
A2P	PRINTED CIRCUIT BOARD (INV)	K3R-4R	MAGNETIC RELAY (M1F)	SENPH
C1R-4R	CAPACITOR	K5R	MAGNETIC RELAY (M2F)	SENPL
F1U-2U	FUSE(250V, 10A)	K8R	MAGNETIC RELAY (Y2S)	T1R
F2C	OVER CURRENT RELAY (M2C)	K9R	MAGNETIC RELAY (Y3S)	T1R
H1P-4P	LIGHT EMITTING DIODE (SERVICE MONITOR -RED) (A2P)	K10R	MAGNETIC RELAY (Y4S)	V1TR
HAP	LIGHT EMITTING DIODE (SERVICE MONITOR -GREEN) (A1P)	K11R	MAGNETIC RELAY (Y5S)	X3M
HAP	LIGHT EMITTING DIODE (SERVICE MONITOR -GREEN) (A2P)	L1R	REACTOR	Y2S
		M1C-2C	MOTOR (COMPRESSOR)	Y3S
		M1F-2F	MOTOR (FAN)	Y4S
		Q1	POWER TRANSISTOR	Y5S
HWL	PILOT LAMP (ALARM-WHITE)	Q1M-2M	THERMO SWITCH (M1F, M2F)	Z1F-3F
INV	INVERTER	R1-4	RESISTOR (A2P)	
J1HC-2HC	CRANECASE HEATER	R1T	THERMISTOR (FIN) (A2P)	DM
J3HC		R1T	THERMISTOR (AIR) (A1P)	F1S
K1M	MAGNETIC CONTACTOR (M1C)	R1V	VARIATOR	PC
K1R-2R	MAGNETIC RELAY (A2P)	R3-1T-2T	THERMISTOR (DISCHARGE)	PM
K1R	MAGNETIC RELAY (J3HC) (A1P)	R4T	THERMISTOR (SUCTION)	PRC
K2M	MAGNETIC CONTACTOR (M2C)	R5-1T-2T	THERMISTOR (OIL)	SD

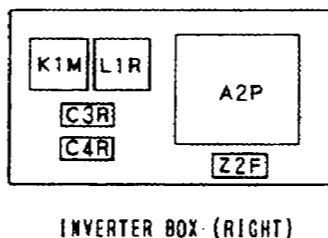
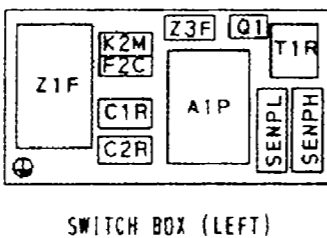

NOTES)

1. : TERMINAL : CONNECTOR : PROTECTIVE EARTH (SCREW)  
 : WIRE CLAMP : FIELD WIRING
2. COLORS:  
 BLK:BLACK RED:RED BLU:BLUE WHT:WHITE YLW:YELLOW ORG:ORANGE BRN:BROWN PNK:PINK GRY:GREY
3. REFER TO THE INSTALLATION MANUAL, FOR CONNECTION WIRING TO FUNCTION UNIT - OUTDOOR-OUTDOOR TRANSMISSION Q1 - Q2.
4. THIS WIRING DIAGRAM IS APPLIED ONLY TO THE OUTDOOR UNIT.

3D001813

(7) PLUS Series Constant speed type (Cooling only)

RN8K-10K

POWER SUPPLY  
 Y1: 3N ~ 50Hz  
 380-415V  
 YAL: 3N ~ 60Hz  
 380V

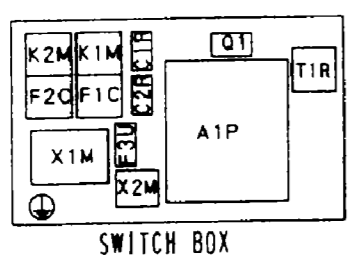
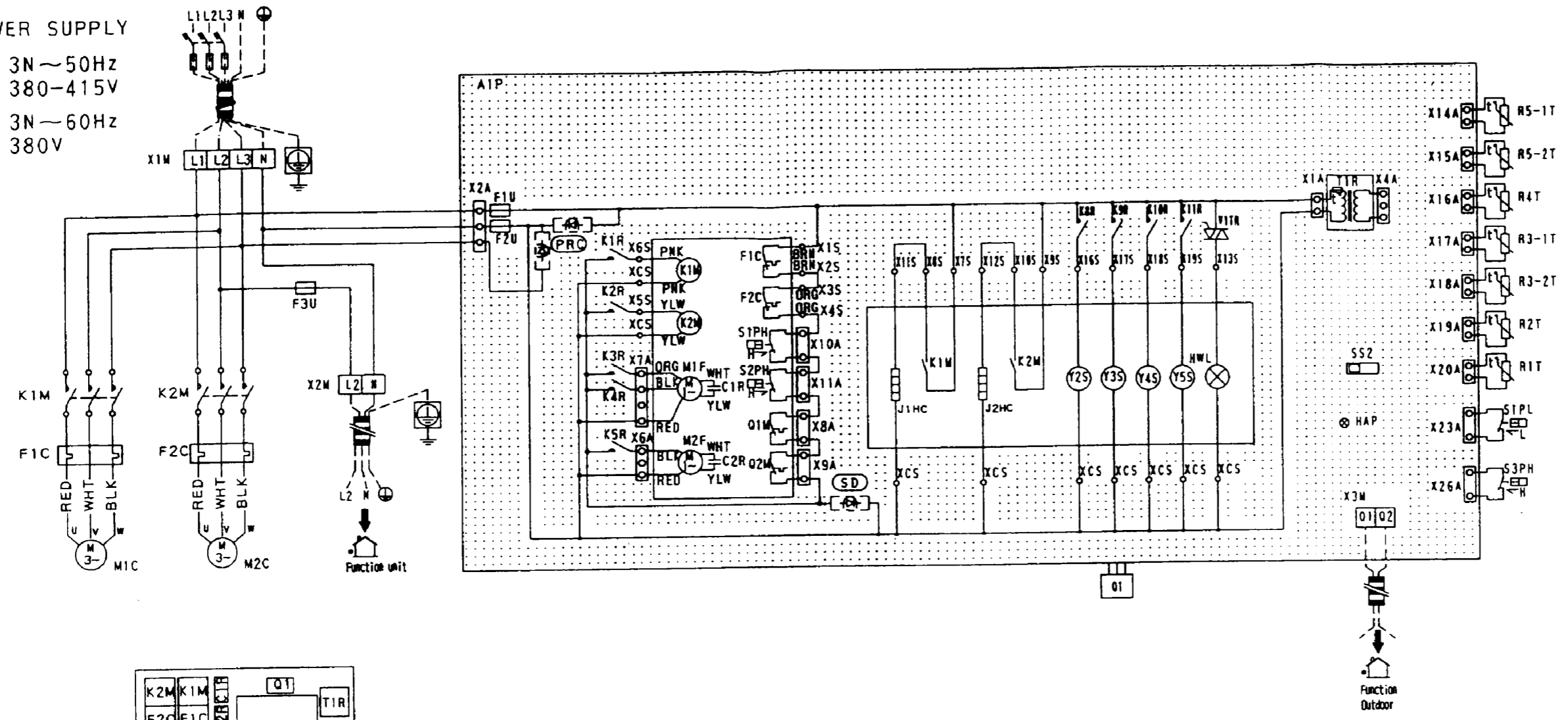

- NOTES)
- : TERMINAL    : CONNECTOR    : PROTECTIVE EARTH (SCREW)  
 : WIRE CLAMP    : FIELD WIRING
  - COLORS:  
 BLK:BLACK RED:RED BLU:BLUE WHT:WHITE YLW:YELLOW ORG:ORANGE BRN:BROWN PNK:PINK GRY:GREY
  - REFER TO THE INSTALLATION MANUAL, FOR CONNECTION WIRING TO FUNCTION UNIT - OUTDOOR-OUTDOOR TRANSMISSION Q1 - Q2.
  - THIS WIRING DIAGRAM IS APPLIED ONLY TO THE OUTDOOR UNIT.

L1-RED	L2-WHT	L3-BLK	N-BLU		
A1P	PRINTED CIRCUIT BOARD	K3R-4R	MAGNETIC RELAY (M1F)	R5-1T-2T	THERMISTOR (OIL)
C1R-2R	CAPACITOR	K5R	MAGNETIC RELAY (M2F)	S1-S2PH	PRESSURE SWITCH (HIGH)
F1C-2C	OVER CURRENT RELAY (M1C-2C)	K8R	MAGNETIC RELAY (Y2S)	S1PL	PRESSURE SWITCH (LOW CONTROL)
F1U-2U	FUSE(250V, 10A)	K9R	MAGNETIC RELAY (Y3S)	S3PH	PRESSURE SWITCH (HIGH CONTROL)
F3U	FUSE(250V, 5A)	K10R	MAGNETIC RELAY (Y4S)	SS2	SYSTEM CHANGEOVER SWITCH
HAP	LIGHT EMITTING DIODE (SERVICE MONITOR -GREEN)	K11R	MAGNETIC RELAY (Y5S)	T1R	TRANSFORMER (220-240V/22V)
HWL	PILOT LAMP (ALARM-WHITE)	M1C-2C	MOTOR (COMPRESSOR)	V1TR	SOLID STATE RELAY
J1HC-2HC	CRANECASE HEATER	M1F-2F	MOTOR (FAN)	X1M-3M	TERMINAL STRIP
K1M	MAGNETIC CONTACTOR (M1C)	Q1	POWER TRANSISTOR	Y2S	SOLENOID VALVE (INJECTION M1C)
K1R	MAGNETIC RELAY (K1M)	Q1M-2M	THERMO SWITCH (M1F, M2F)	Y3S	SOLENOID VALVE (INJECTION M2C)
K2M	MAGNETIC CONTACTOR (M2C)	R1T	THERMISTOR (AIR)	Y4S	SOLENOID VALVE (HOTGAS EQUILIZING)
K2R	MAGNETIC RELAY (K2M)	R2T	THERMISTOR (CRIL)	Y5S	SOLENOID VALVE (OIL SUCTION)
		R3-1T-2T	THERMISTOR (DISCHARGE)	PRC	PHASE REVERSAL DETECT CIRCUIT
		R4T	THERMISTOR (SUCTION)	SD	SAFETY DEVICES INPUT

## (8) Indoor unit

### ■ Ceiling mounted cassette type (Double-flow)

#### ● FXYC20K/25K/32K/63KVE

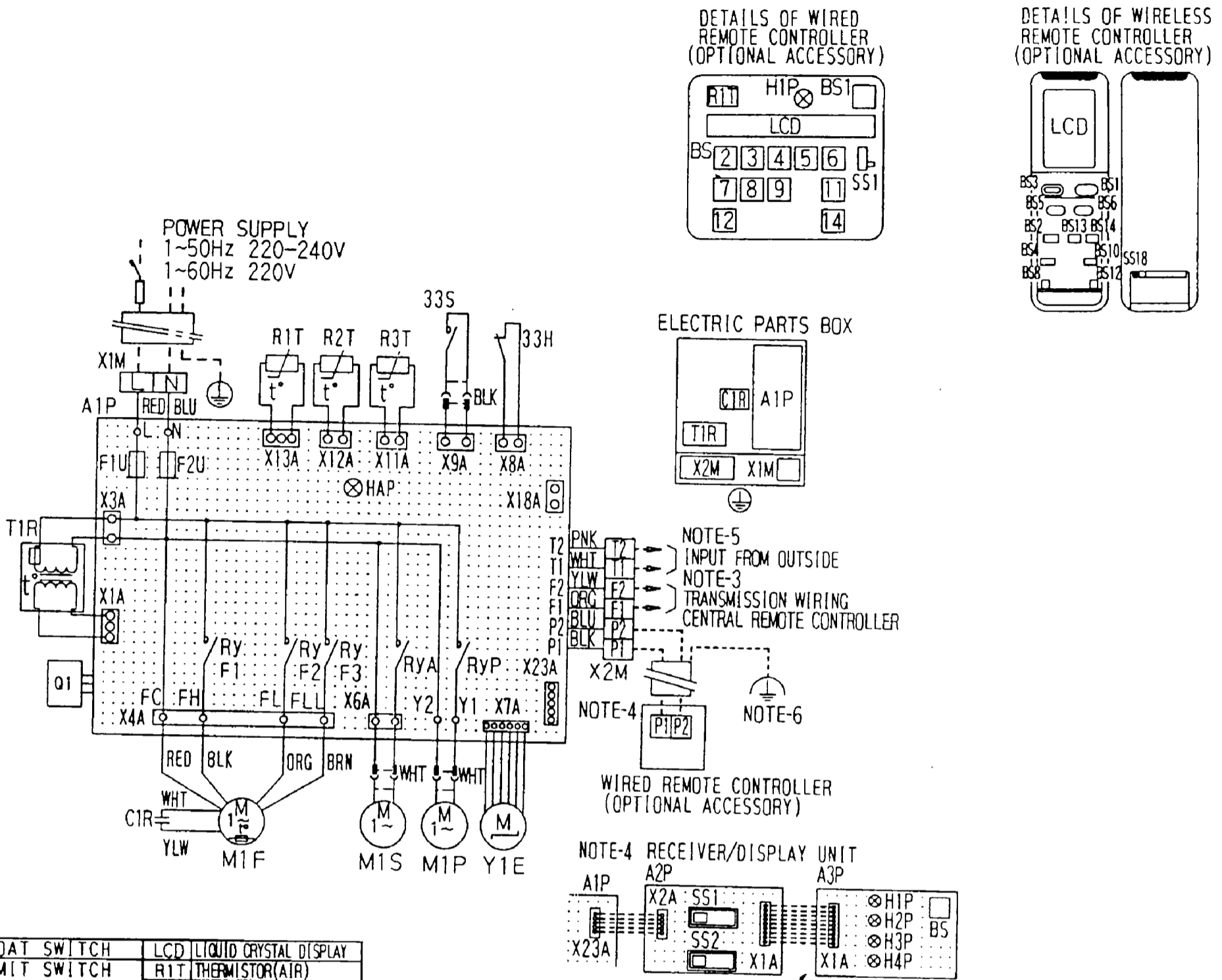

33H	FLOAT SWITCH	LCD	LIQUID CRYSTAL DISPLAY
33S	LIMIT SWITCH (SWING FLAP)	R1T	THERMISTOR(AIR)
		SS1	SELECTOR SWITCH (MAIN/SUB)
A1P	PRINTED CIRCUIT BOARD	WIRELESS REMOTE CONTROLLER (BRC7A62-67)	
C1R	CAPACITOR (M1F)	BS1	PUSH BUTTON (ON/OFF)
F1T	THERMAL FUSE (152°C) (M1F EMBEDDED)	BS2	PUSH BUTTON (TIMER MODE START/STOP)
F1U·F2U	FUSE (250V, 5A)	BS3	PUSH BUTTON (FAN SPEED)
HAP	LIGHT EMISSION DIODE (SERVICE MONITOR-GREEN)	BS4	PUSH BUTTON (AIR FLOW DIRECTION ADJUST)
M1F	MOTOR (INDOOR FAN)	BS5·6	PUSH BUTTON (TIME/TEMPERATURE SET)
M1S	MOTOR (SWING FLAP)	BS8	PUSH BUTTON (INSPECTION/TEST)
M1P	MOTOR (DRAIN PUMP)	BS10	PUSH BUTTON (MODE SELECTOR)
Q1	POWER TRANSISTOR	BS12	PUSH BUTTON (FILTER SIGN RESET)
R1T	THERMISTOR (AIR)	BS13	PUSH BUTTON (TIMER ON)
R2T·R3T	THERMISTOR (COIL)	BS14	PUSH BUTTON (TIMER OFF)
RYA	MAGNETIC RELAY (M1S)	LCD	LIQUID CRYSTAL DISPLAY
RYF1-3	MAGNETIC RELAY (M1F)	SS18	SELECTOR SWITCH (WIRELESS ADDRESS SET)
RYP	MAGNETIC RELAY (M1P)	RECEIVER/DISPLAY UNIT (ATTACHED TO WIRELESS REMOTE CONTROLLER)	
T1R	TRANSFORMER (220-240V/27V)	A2P	PRINTED CIRCUIT BOARD
X1M	TERMINAL STRIP (POWER)	A3P	PRINTED CIRCUIT BOARD
X2M	TERMINAL STRIP (CONTROL)	BS	PUSH BUTTON (ON/OFF)
Y1E	ELECTRONIC EXPANSION VALVE	H1P	LIGHT EMISSION DIODE (ON-RED)
WIRELESS REMOTE CONTROLLER (BRC7A61)		H2P	LIGHT EMISSION DIODE (TIMER-GREEN)
BS1	PUSH BUTTON (ON/OFF)	H3P	LIGHT EMISSION DIODE (FILTER SIGN-RED)
BS2	PUSH BUTTON (TIMER MODE START/STOP)	H4P	LIGHT EMISSION DIODE (DEFROST-ORANGE)
BS3·8	PUSH BUTTON (PROGRAMING TIME)	SS1	SELECTOR SWITCH (MAIN/SUB)
BS4·9	PUSH BUTTON (TEMPERATURE SET)	SS2	SELECTOR SWITCH (WIRELESS ADDRESS SET)
BS5	PUSH BUTTON (AIR FLOW DIRECTION ADJUST)	CONNECTOR FOR OPTIONAL PARTS	
BS6	PUSH BUTTON (MODE SELECTOR)	X18A	CONNECTOR/WIRING ADAPTOR FOR ELECTRICAL APPENDICES
BS7	PUSH BUTTON (TIMER ON/OFF)	X23A	CONNECTOR/WIRELESS REMOTE CONTROLLER
BS11	PUSH BUTTON (FAN SPEED)		
BS12	PUSH BUTTON (INSPECTION/TEST)		
BS14	PUSH BUTTON (FILTER SIGN RESET)		
H1P	LIGHT EMISSION DIODE (ON-RED)		

#### NOTES)

1. : TERMINAL : CONNECTOR
2. - - - - : FIELD WIRING
3. IN CASE USING CENTRAL REMOTE CONTROLLER, CONNECT IT TO THE UNIT IN ACCORDANCE WITH THE ATTACHED INSTRUCTION MANUAL.
4. X23A IS CONNECTED WHEN THE WIRELESS REMOTE CONTROLLER KIT (BRC7A62-67) IS BEING USED.
5. WHEN CONNECTING THE INPUT WIRES FROM OUTSIDE, FORCED OFF OR ON/OFF CONTROL OPERATION CAN BE SELECTED BY REMOTE CONTROLLER. IN DETAILS, REFER TO THE INSTALLATION MANUAL ATTACHED THE UNIT.
6. GROUND THE SHIELD OF THE REMOTE CONTROLLER CORD TO THE INDOOR UNIT.  
(ELECTROMAGNETIC COMPATIBILITY TO THE ELECTRICAL APPLIANCE AND MATERIAL CONTROL LAW OF JAPAN, ALSO THE GROUNDING SHOWN IN THE FIGURE IS UNNECESSARY.)
7. SYMBOLS SHOWS AS FOLLOWS,  
(PNK:PINK WHT:WHITE YLW:YELLOW ORG:ORANGE)  
(BLU:BLUE BLK:BLACK RED:RED BRN:BROWN)
8. USE COPPER CONDUCTORS ONLY.

# ■ Ceiling mounted cassette type (Double-flow)

● FXYC40K/50K/80K/125KVE

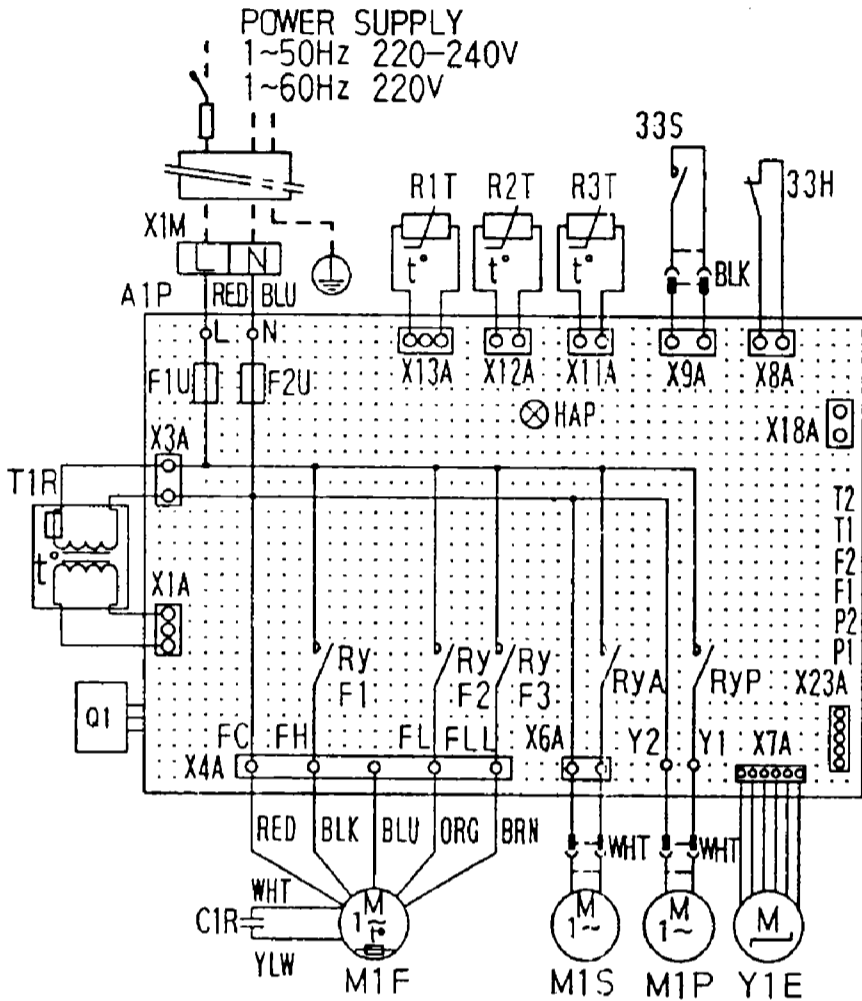

DETAILS OF WIRED REMOTE CONTROLLER (OPTIONAL ACCESSORY)

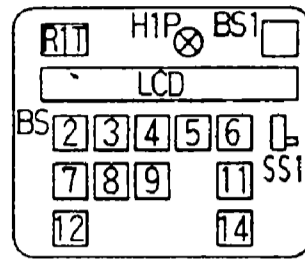

DETAILS OF WIRELESS REMOTE CONTROLLER (OPTIONAL ACCESSORY)

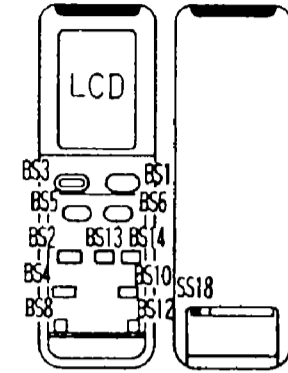

ELECTRIC PARTS BOX

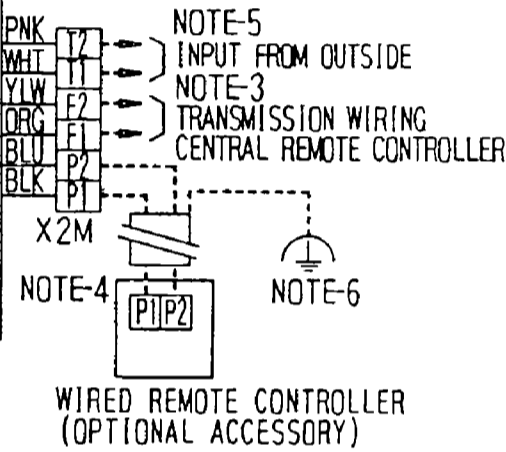
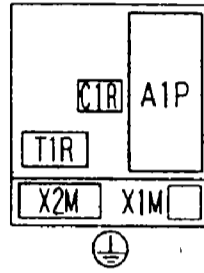

NOTE-4 RECEIVER/DISPLAY UNIT

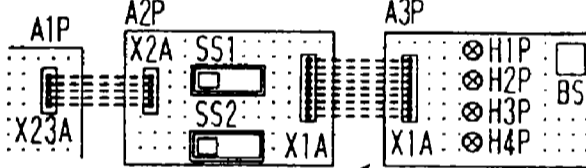

33H	FLOAT SWITCH	LCD	LIQUID CRYSTAL DISPLAY
33S	LIMIT SWITCH (SWING FLAP)	R1T	THERMISTOR(AIR)
A1P	PRINTED CIRCUIT BOARD	SS1	SELECTOR SWITCH (MAIN/SUB)
C1R	CAPACITOR (M1F)	BS1	PUSH BUTTON (ON/OFF)
F1T	THERMAL FUSE (152°C) (M1F EMBEDDED)	BS2	PUSH BUTTON (TIMER MODE START/STOP)
F1U-2U	FUSE (250V, 5A)	BS3	PUSH BUTTON (FAN SPEED)
HAP	LIGHT EMISSION DIODE (SERVICE MONITOR-GREEN)	BS4	PUSH BUTTON (AIR FLOW DIRECTION ADJUST)
M1F	MOTOR (INDOOR FAN)	BS5-6	PUSH BUTTON (TIME/TEMPERATURE SET)
M1S	MOTOR (SWING FLAP)	BS8	PUSH BUTTON (INSPECTION/TEST)
M1P	MOTOR (DRAIN PUMP)	BS10	PUSH BUTTON (MODE SELECTOR)
Q1	POWER TRANSISTOR	BS12	PUSH BUTTON (FILTER SIGN RESET)
R1T	THERMISTOR(AIR)	BS13	PUSH BUTTON (TIMER ON)
R2T-3T	THERMISTOR(COIL)	BS14	PUSH BUTTON (TIMER OFF)
RYA	MAGNETIC RELAY (M1S)	LCD	LIQUID CRYSTAL DISPLAY
RYF1-3	MAGNETIC RELAY (M1F)	SS18	SELECTOR SWITCH (WIRELESS ADDRESS SET)
RYP	MAGNETIC RELAY (M1P)	A2P	PRINTED CIRCUIT BOARD
T1R	TRANSFORMER(220-240V/27V)	A3P	PRINTED CIRCUIT BOARD
X1M	TERMINAL STRIP(POWER)	BS	PUSH BUTTON (ON/OFF)
X2M	TERMINAL STRIP(CONTROL)	H1P	LIGHT EMISSION DIODE (ON-RED)
Y1E	ELECTRONIC EXPANSION VALVE	H2P	LIGHT EMISSION DIODE (TIMER-GREEN)
WIRED REMOTE CONTROLLER (BRC7A61)		H3P	LIGHT EMISSION DIODE (FILTER SIGN-RED)
BS1	PUSH BUTTON (ON/OFF)	H4P	LIGHT EMISSION DIODE (DEFROST-ORANGE)
BS2	PUSH BUTTON (TIMER MODE START/STOP)	SS1	SELECTOR SWITCH (MAIN/SUB)
BS3-8	PUSH BUTTON (PROGRAMING TIME)	SS2	SELECTOR SWITCH (WIRELESS ADDRESS SET)
BS4-9	PUSH BUTTON (TEMPERATURE SET)	CONNECTOR FOR OPTIONAL PARTS	
BS5	PUSH BUTTON (AIR FLOW DIRECTION ADJUST)	X18A	CONNECTOR(WIRING ADAPTOR FOR ELECTRICAL APPENDICES)
BS6	PUSH BUTTON (MODE SELECTOR)	X23A	CONNECTOR(WIRELESS REMOTE CONTROLLER)
BS7	PUSH BUTTON (TIMER ON/OFF)		
BS11	PUSH BUTTON (FAN SPEED)		
BS12	PUSH BUTTON (INSPECTION/TEST)		
BS14	PUSH BUTTON (FILTER SIGN RESET)		
H1P	LIGHT EMISSION DIODE (ON-RED)		

NOTES)

1. [Symbol] : TERMINAL [Symbol], [Symbol] : CONNECTOR
2. [Symbol] : FIELD WIRING
3. IN CASE USING CENTRAL REMOTE CONTROLLER, CONNECT IT TO THE UNIT IN ACCORDANCE WITH THE ATTACHED INSTRUCTION MANUAL.
4. X23A IS CONNECTED WHEN THE WIRELESS REMOTE CONTROLLER KIT (BRC7A62-67) IS BEING USED.
5. WHEN CONNECTING THE INPUT WIRES FROM OUTSIDE, FORCED OFF OR ON/OFF CONTROL OPERATION CAN BE SELECTED BY REMOTE CONTROLLER. IN DETAILS, REFER TO THE INSTALLATION MANUAL ATTACHED THE UNIT.
6. GROUND THE SHIELD OF THE REMOTE CONTROLLER CORD TO THE INDOOR UNIT. (ELECTROMAGNETIC COMPATIBILITY TO THE ELECTRICAL APPLIANCE AND MATERIAL CONTROL LAW OF JAPAN, ALSO) THE GROUNDING SHOWN IN THE FIGURE IS UNNECESSARY.
7. SYMBOLS SHOWS AS FOLLOWS, (PNK:PINK WHT:WHITE YLW:YELLOW ORG:ORANGE) (BLU:BLUE BLK:BLACK RED:RED BRN:BROWN)
8. USE COPPER CONDUCTORS ONLY.

# Ceiling mounted cassette type (Multi-flow)

● FXYF32K/40K/50K/63K/80K/100K/125KVE

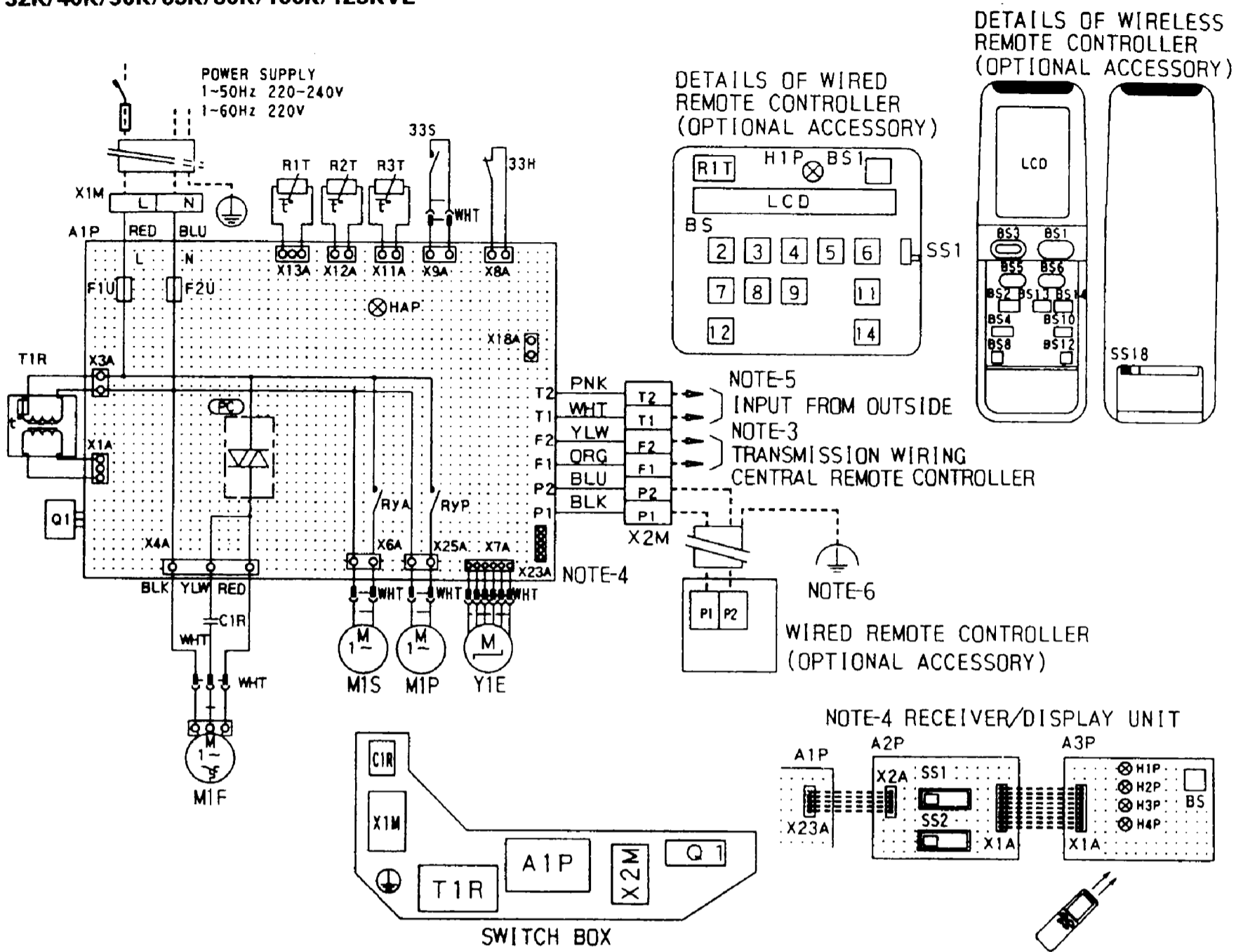

33H	FLOAT SWITCH	LCD	LIQUID CRYSTAL DISPLAY	CONNECTOR FOR OPTIONAL PARTS
33S	LIMIT SWITCH(SWING FLAP)	R1T	THERMISTOR(AIR)	X18A
A1P	PRINTED CIRCUIT BOARD	SS1	SELECTOR SWITCH(MAIN/SUB)	CONNECTOR(WIRING ADAPTOR FOR ELECTRICAL APPENDICES)
C1R	CAPACITOR(M1F)	WIRELESS REMOTE CONTROLLER(BRC7A61W-66W)	X23A	CONNECTOR(WIRELESS REMOTE CONTROLLER)
F1U·2U	FUSE (250V,5A)	BS1	PUSH BUTTON(ON/OFF)	
HAP	LIGHT EMISSION DIODE (SERVICE MONITOR-GREEN)	BS2	PUSH BUTTON (TIMER MODE START/STOP)	
M1F	MOTOR (INDOOR FAN)	BS3	PUSH BUTTON(FAN SPEED)	
M1P	MOTOR (DRAIN PUMP)	BS4	PUSH BUTTON(AIR FLOW DIRECTION ADJUST)	
M1S	MOTOR (SWING FLAP)	BS5·6	PUSH BUTTON (TIME/TEMPERATURE SET)	
Q1	POWER TRANSISTOR	BS8	PUSH BUTTON (INSPECTION/TEST)	
Q1F	THERMO SWITCH(M1F EMBEDDED)	BS10	PUSH BUTTON (MODE SELECTOR)	
R1T	THERMISTOR(AIR)	BS12	PUSH BUTTON (FILTER SIGN RESET)	
R2T·3T	THERMISTOR(COIL)	BS13	PUSH BUTTON(TIMER ON)	
RYA	MAGNETIC RELAY(M1S)	BS14	PUSH BUTTON(TIMER OFF)	
RYP	MAGNETIC RELAY(M1P)	LCD	LIQUID CRYSTAL DISPLAY	
T1R	TRANSFORMER(220-240V/27V)	SS18	SELECTOR SWITCH (WIRELESS ADDRESS SET)	
X1M	TERMINAL STRIP(POWER)	RECEIVER/DISPLAY UNIT(ATTACHED TO WIRELESS REMOTE CONTROLLER)		
X2M	TERMINAL STRIP(CONTROL)	A2P	PRINTED CIRCUIT BOARD	
Y1E	ELECTRONIC EXPANSION VALVE	A3P	PRINTED CIRCUIT BOARD	
PC	PHASE CONTROL CIRCUIT	BS	PUSH BUTTON(ON/OFF)	
WIRED REMOTE CONTROLLER (BRC1A61)		H1P	LIGHT EMISSION DIODE (ON-RED)	
BS1	PUSH BUTTON(ON/OFF)	H2P	LIGHT EMISSION DIODE (TIMER-GREEN)	
BS2	PUSH BUTTON (TIMER MODE START/STOP)	H3P	LIGHT EMISSION DIODE (FILTER SIGN-RED)	
BS3·8	PUSH BUTTON (PROGRAMING TIME)	H4P	LIGHT EMISSION DIODE (DEFROST-ORANGE)	
BS4·9	PUSH BUTTON (TEMPERATURE SET)	SS1	SELECTOR SWITCH (MAIN/SUB)	
BS5	PUSH BUTTON(AIR FLOW DIRECTION ADJUST)	SS2	SELECTOR SWITCH (WIRELESS ADDRESS SET)	
BS6	PUSH BUTTON(MODE SELECTOR)			
BS7	PUSH BUTTON(TIMER ON/OFF)			
BS11	PUSH BUTTON(FAN SPEED)			
BS12	PUSH BUTTON (INSPECTION/TEST)			
BS14	PUSH BUTTON (FILTER SIGN RESET)			
H1P	LIGHT EMISSION DIODE (ON-RED)			

- NOTES)
1. □□□□ : TERMINAL  
⊗, ⊚ : CONNECTOR
  2. ---- : FIELD WIRING
  3. IN CASE USING CENTRAL REMOTE CONTROLLER, CONNECT IT TO THE UNIT IN ACCORDANCE WITH THE ATTACHED INSTRUCTION MANUAL.
  4. X23A IS CONNECTED WHEN THE WIRELESS REMOTE CONTROLLER KIT (BRC7A61W-66W) IS BEING USED.
  5. WHEN CONNECTING THE INPUT WIRES FROM OUTSIDE, FORCED OFF OR ON/OFF CONTROL OPERATION CAN BE SELECTED BY REMOTE CONTROLLER MANUAL. IN DETAILS, REFER TO THE INSTALLATION MANUAL ATTACHED THE UNIT.
  6. GROUND THE SHIELD OF THE REMOTE CONTROLLER CORD TO THE INDOOR UNIT. (ELECTROMAGNETIC COMPATIBILITY TO THE ELECTRICAL APPLIANCE AND MATERIAL CONTROL LAW OF JAPAN, ALSO THE GROUNDING SHOWN IN THE FIGURE IS UNNECESSARY.)
  7. SYMBOLS SHOWS AS FOLLOWS  
(PNK:PINK WHT:WHITE YLW:YELLOW ORG:ORANGE)  
(BLU:BLUE BLK:BLACK RED:RED)
  8. USE COPPER CONDUCTORS ONLY.



# Ceiling mounted cassette type (Multi-flow)

## ● FXYF32KG/40KG/50KG/63KGV1

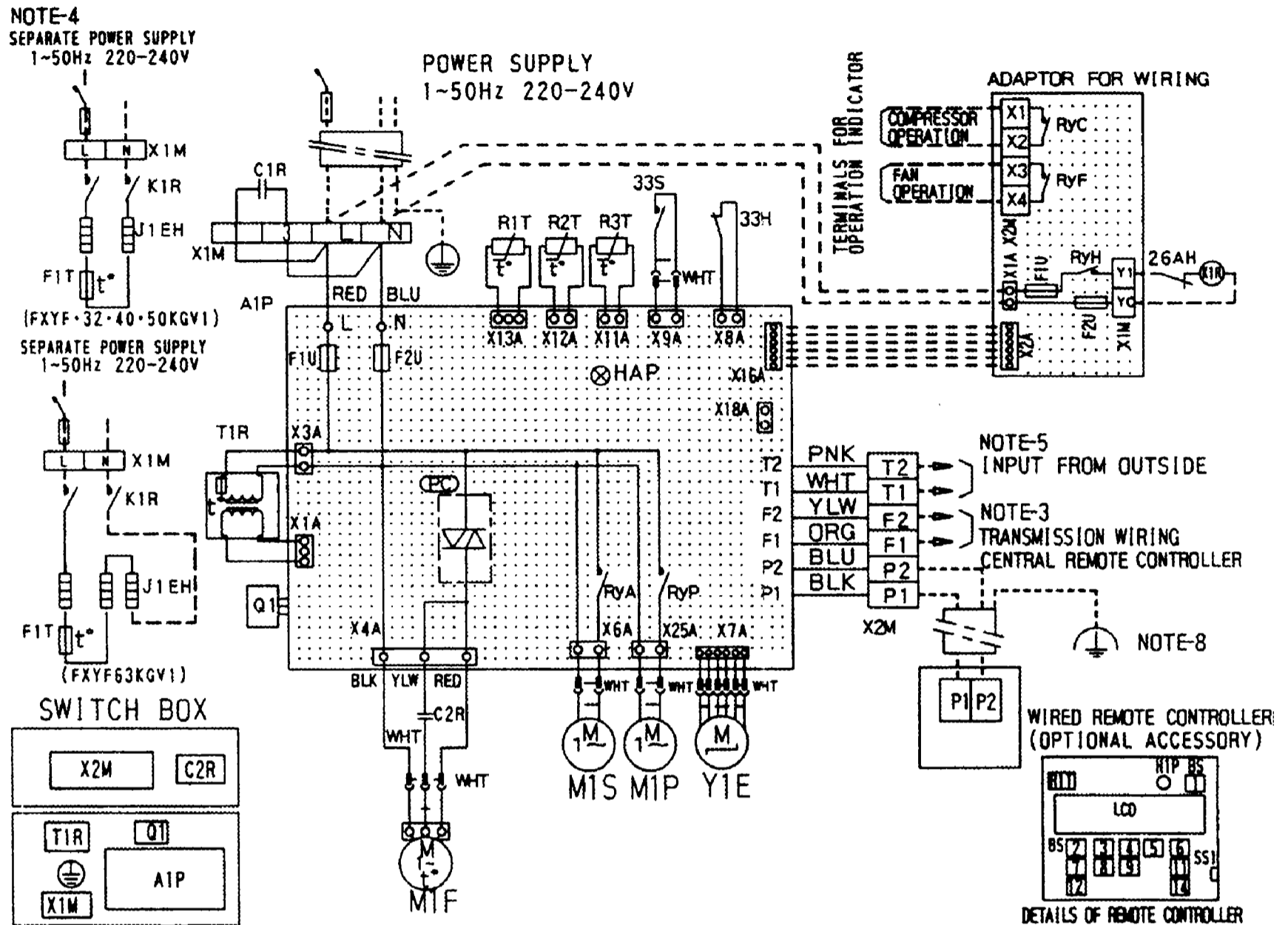

### NOTES)

1. : TERMINAL : PRINTED CIRCUIT BOARD : CONNECTOR
2. - - - : FIELD WIRING
3. IN CASE USING CENTRAL REMOTE CONTROLLER, CONNECT IT TO THE UNIT IN ACCORDANCE WITH THE ATTACHED INSTRUCTION MANUAL.
4. IN CASE INSTALLING THE ELECTRIC HEATER, EXECUTE THE ADDITIONAL WIRING FOR HEATER CIRCUIT(26AH, K1R, J1EH) IN THIS CASE, THE MAIN POWER SUPPLY HAS TO BE SUPPLIED INDEPENDENTLY.
5. WHEN CONNECTING THE INPUT WIRES FROM OUTSIDE, FORCED OFF OR ON/OFF CONTROL OPERATION CAN BE SELECTED BY REMOTE CONTROLLER. IN DETAILS, REFER TO THE INSTALLATION MANUAL ATTACHED TO THE UNIT.
6. USE COPPER CONDUCTORS ONLY.
7. SYMBOLS SHOW AS FOLLOWS. PNK:PINK WHT:WHITE YLW:YELLOW ORG:ORANGE BLU:BLUE  
BLK:BLACK GRY:GRAY PRP:PURPLE RED:RED BRN:BROWN
8. GROUND THE SHIELD OF THE REMOTE CONTROLLER CORD TO THE INDOOR UNIT. ELECTROMAGNETIC COMPATIBILITY TO THE ELECTRICAL APPLIANCE AND MATERIAL CONTROL LAW OF JAPAN, ALSO THE GROUNDING SHOWN IN THE FIGURE IS UNNECESSARY.

33H	FLOAT SWITCH	X1M	TERMINAL STRIP(POWER)	BS11	PUSH BUTTON(FAN SPEED)
33S	LIMIT SWITCH(SWING FLAP)	X2M	TERMINAL STRIP(CONTROL)	BS12	PUSH BUTTON(INSPECTION/TEST)
A1P	PRINTED CIRCUIT BOARD	Y1E	EXPANSION VALVE(ELECTRONIC TYPE)	BS14	PUSH BUTTON(FILTER SIGN RESET)
C1R	CAPACITOR	(PC)	PHASE CONTROL CIRCUIT	H1P	LIGHT EMISSION DIODE (ON-RED)
C2R	CAPACITOR(M1F)		OPTIONAL PARTS	LCD	LIQUID CRYSTAL DISPLAY
F1U - F2U	FUSE (250V, 5A)	26AH	THERMO SWITCH	R1T	THERMISTOR(AIR)
HAP	LIGHT EMISSION DIODE (SERVICE MONITOR-GREEN)	J1EH	ELECTRIC HEATER	SS1	SELECTOR SWITCH(MAIN/SUB)
M1F	MOTOR(FAN)	K1R	MAGNETIC RELAY(J1EH)	F1U - F2U	FUSE (250V, 5A)
M1P	MOTOR(DRAIN PUMP)		REMOTE CONTROLLER(BRCTAG1)	R1C	MAGNETIC RELAY
M1S	MOTOR(SWING FLAP)	BS1	PUSH BUTTON(ON/OFF)	R1F	MAGNETIC RELAY
Q1	POWER TRANSISTOR	BS2	PUSH BUTTON(TIMER MODE START/STOP)	R1H	MAGNETIC RELAY(J1EH)
Q1F	THERMO SWITCH(M1F EMBEDDED)	BS3-8	PUSH BUTTON(PROGRAMMING TIME)		CONNECTOR FOR OPTIONAL PARTS
R1T	THERMISTOR(AIR)	BS4-9	PUSH BUTTON(TEMPERATURE SETTING)	X16A	CONNECTOR(ADAPTOR FOR WIRING)
R2T - J1T	THERMISTOR(REFRIGERANT)	BS5	PUSH BUTTON(AIR FLOW DIRECTION ADJUST)	X18A	CONNECTOR(WIRING ADAPTOR FOR ELECTRICAL APPENDICES)
R1A	MAGNETIC RELAY(M1S)				
R1P	MAGNETIC RELAY(M1P)	BS6	PUSH BUTTON(MODE SELECTOR)		
T1R	TRANSFORMER(220-240V/27V)	BS7	PUSH BUTTON(TIMER ON/OFF)		

# ■ Ceiling mounted cassette type (Multi-flow)

## ● FXYF80KG/100KG/125KGV1

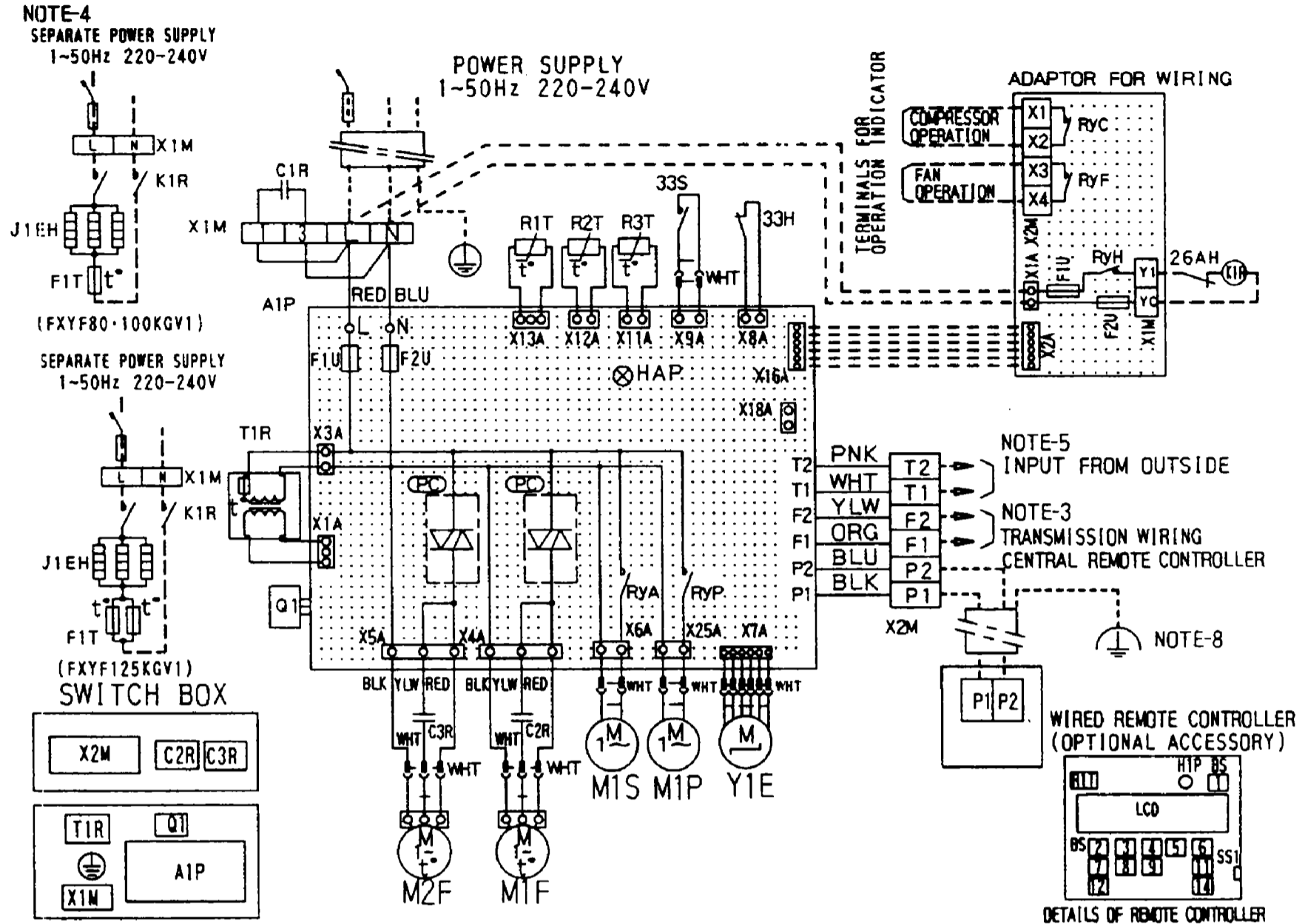

### NOTES

1. □ □ □ □ : TERMINAL    ▨ : PRINTED CIRCUIT BOARD    ○ ○ , ⊕ : CONNECTOR
2. - - - : FIELD WIRING
3. IN CASE USING CENTRAL REMOTE CONTROLLER, CONNECT IT TO THE UNIT IN ACCORDANCE WITH THE ATTACHED INSTRUCTION MANUAL.
4. IN CASE INSTALLING THE ELECTRIC HEATER, EXECUTE THE ADDITIONAL WIRING FOR HEATER CIRCUIT(26AH, K1R, J1EH) IN THIS CASE, THE MAIN POWER SUPPLY HAS TO BE SUPPLIED INDEPENDENTLY.
5. WHEN CONNECTING THE INPUT WIRES FROM OUTSIDE, FORCED OFF OR ON/OFF CONTROL OPERATION CAN BE SELECTED BY REMOTE CONTROLLER. IN DETAILS, REFER TO THE INSTALLATION MANUAL ATTACHED TO THE UNIT.
6. USE COPPER CONDUCTORS ONLY.
7. SYMBOLS SHOW AS FOLLOWS,    PNK:PINK    WHT:WHITE    YLW:YELLOW    ORG:ORANGE    BLU:BLUE  
BLK:BLACK    GRY:GRAY    PRP:PURPLE    RED:RED    BRN:BROWN
8. GROUND THE SHIELD OF THE REMOTE CONTROLLER CORD TO THE INDOOR UNIT. ELECTROMAGNETIC COMPATIBILITY TO THE ELECTRICAL APPLIANCE AND MATERIAL CONTROL LAW OF JAPAN, ALSO THE GROUNDING SHOWN IN THE FIGURE IS UNNECESSARY.

33H	FLOAT SWITCH	X1M	TERMINAL STRIP(POWER)	BS11	PUSH BUTTON(FAN SPEED)
33S	LIMIT SWITCH(SWING FLAP)	X2M	TERMINAL STRIP(CONTROL)	BS12	PUSH BUTTON(INSPECTION/TEST)
A1P	PRINTED CIRCUIT BOARD	Y1E	EXPANSION VALVE(ELECTRONIC TYPE)	BS14	PUSH BUTTON(FILTER SIGN RESET)
C1R	CAPACITOR	(PC)	PHASE CONTROL CIRCUIT	LCD	LIQUID CRYSTAL DISPLAY
C2R·C3R	CAPACITOR(M1F, M2F)		OPTIONAL PARTS	H1P	LIGHT EMISSION DIODE (ON-RED)
F1U·F2U	FUSE (250V, 5A)	26AH	THERMO SWITCH	R1T	THERMISTOR(AIR)
HAP	LIGHT EMISSION DIODE (SERVICE MONITOR-GREEN)	J1EH	ELECTRIC HEATER	SS1	SELECTOR SWITCH(MAIN/SUB)
M1F·M2F	MOTOR(FAN)	K1R	MAGNETIC RELAY(J1EH)	F1U·F2U	FUSE (250V, 5A)
M1P	MOTOR(DRAIN PUMP)		REMOTE CONTROLLER(BRC1A61)	RyC	MAGNETIC RELAY
M1S	MOTOR(SWING FLAP)	BS1	PUSH BUTTON(ON/OFF)	RyF	MAGNETIC RELAY
Q1	POWER TRANSISTOR	BS2	PUSH BUTTON(TIMER MODE START/STOP)	RyH	MAGNETIC RELAY(J1EH)
Q1F	THERMO SWITCH(M1F, M2F EMBEDDED)	BS3·8	PUSH BUTTON(PROGRAMMING TIME)		CONNECTOR FOR OPTIONAL PARTS
R1T	THERMISTOR(AIR)	BS4·9	PUSH BUTTON(TEMPERATURE SETTING)	X16A	CONNECTOR(ADAPTOR FOR WIRING)
R2T·R3T	THERMISTOR(REFRIGERANT)	BS5	PUSH BUTTON(AIR FLOW DIRECTION ADJUST)	X18A	CONNECTOR(WIRING ADAPTOR FOR ELECTRICAL APPENDICES)
RyA	MAGNETIC RELAY(M1S)	BS6	PUSH BUTTON(MODE SELECTOR)		
RyP	MAGNETIC RELAY(M1P)	BS7	PUSH BUTTON(TIMER ON/OFF)		
T1R	TRANSFORMER(220~240V/27V)				

# Ceiling mounted cassette corner type

## ● FXYK25K/32K/40K/63KV1, VAL

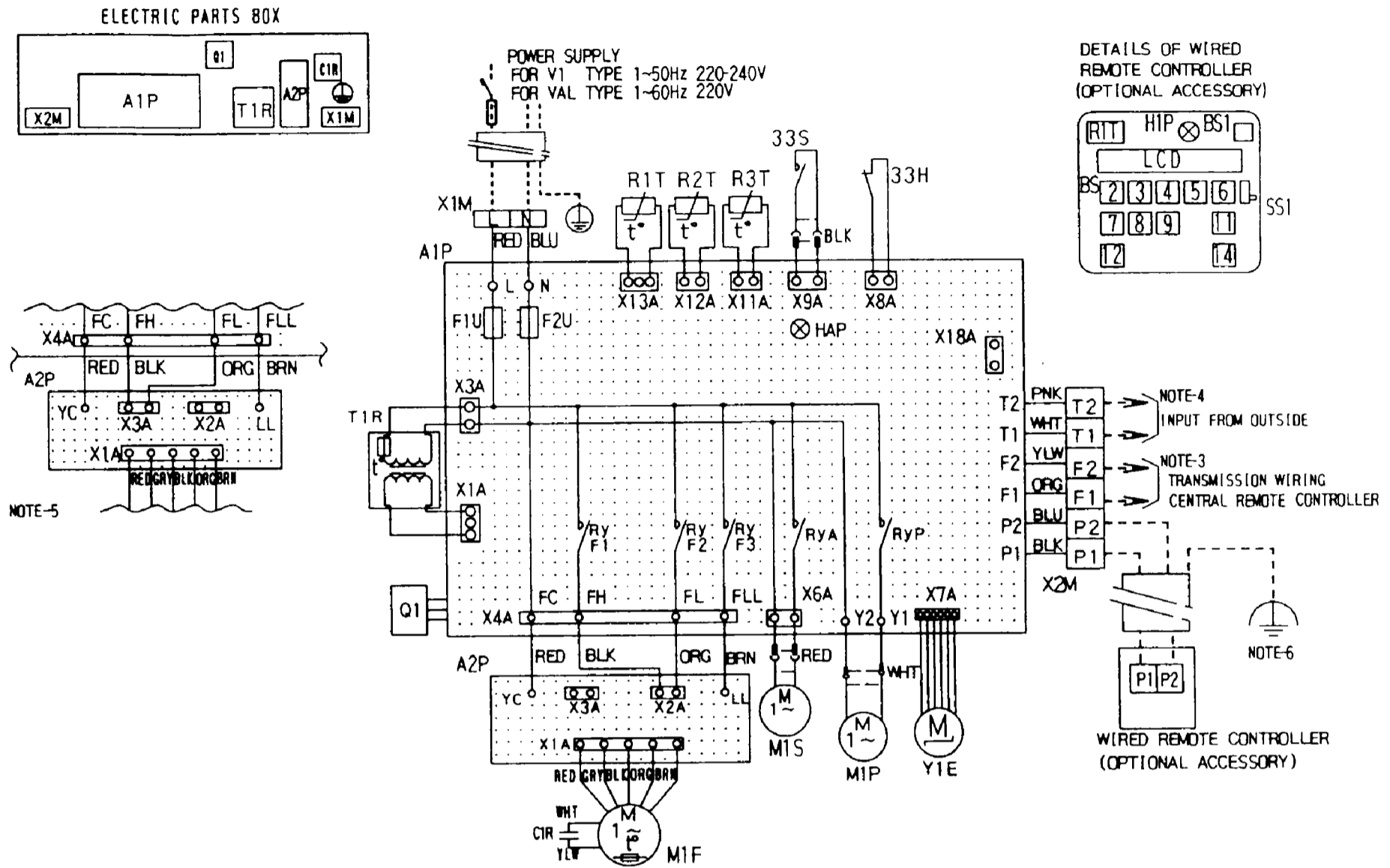

- NOTES) 1. : TERMINAL, : CONNECTOR, : WIRE CLAMP
2. ---- : FIELD WIRING
3. IN CASE USING CENTRAL REMOTE CONTROLLER, CONNECT IT TO THE UNIT IN ACCORDANCE WITH THE ATTACHED INSTRUCTION MANUAL.
4. WHEN CONNECTING THE INPUT WIRES FROM OUTSIDE, FORCED OFF OR ON/OFF CONTROL OPERATION CAN BE SELECTED BY REMOTE CONTROLLER IN DETAILS, REFER TO THE INSTALLATION MANUAL ATTACHED THE UNIT.
5. IN CASE HIGH E.S.P. OPERATION, CHANGE OVER THE WIRING CONNECTION FROM X2A TO X3A.
6. GROUND THE SHIELD OF THE REMOTE CONTROLLER CORD TO THE INDOOR UNIT. (ELECTROMAGNETIC COMPATIBILITY TO THE ELECTRICAL APPLIANCE AND MATERIAL CONTROL LAW OF JAPAN; ALSO THE GROUNDING SHOWN IN THE FIGURE IS UNNECESSARY.)
7. SYMBOLS SHOW AS FOLLOWS.(PNK:PINK WHT:WHITE YLW:YELLOW ORG:ORANGE BLU:BLUE BLK:BLACK RED:RED BRN:BROWN GRY:GRAY)
8. USE COPPER CONDUCTORS ONLY.

33H	FLOAT SWITCH	X2M	TERMINAL STRIP(CONTROL)	BS14	PUSH BUTTON (FILTER SIGN RESET)
33S	LIMIT SWITCH(SWING FLAP)	Y1E	ELECTRONIC EXPANSION VALVE	H1P	LIGHT EMISSION DIODE (ON-RED)
A1P	PRINTED CIRCUIT BOARD	WIRED REMOTE CONTROLLER(BRC1A61)		LCD	LIQUID CRYSTAL DISPLAY
A2P	TERMINAL BOARD	BS1	PUSH BUTTON(ON/OFF)	R1T	THERMISTOR(AIR)
C1R	CAPACITOR (M1F)	BS2	PUSH BUTTON (TIMER MODE START/STOP)	SS1	SELECTOR SWITCH (MAIN/SUB)
F1T	THERMAL FUSE(105°C) (M1F EMBEDDED)	BS3-8	PUSH BUTTON (PROGRAMING TIME)	X18A	CONNECTOR(WIRING ADAPTOR FOR ELECTRICAL APPENDICES)
F1U-2U	FUSE (250V, 5A)	BS4-9	PUSH BUTTON (TEMPERATURE SET)		
HAP	LIGHT EMISSION DIODE (SERVICE MONITOR-GREEN)	BS5	PUSH BUTTON(AIR FLOW DIRECTION ADJUST)		
M1F	MOTOR (INDOOR FAN)	BS6	PUSH BUTTON (MODE SELECTOR)		
M1P	MOTOR (DRAIN PUMP)	BS7	PUSH BUTTON (TIMER ON/OFF)		
M1S	MOTOR (SWING FLAP)	BS11	PUSH BUTTON(FAN SPEED)		
Q1	POWER TRANSISTOR	BS12	PUSH BUTTON (INSPECTION/TEST)		
R1T	THERMISTOR(AIR)				
R2T-3T	THERMISTOR(COIL)				
RYA	MAGNETIC RELAY(M1S)				
RyF1-3	MAGNETIC RELAY(M1F)				
RYP	MAGNETIC RELAY(M1P)				
T1R	TRANSFORMER(220-240V/27V)				
X1M	TERMINAL STRIP(POWER)				

# Ceiling mounted cassette built-in type

## ● FXYS20K/25K/32K/40K/50K/63KV1, VAL

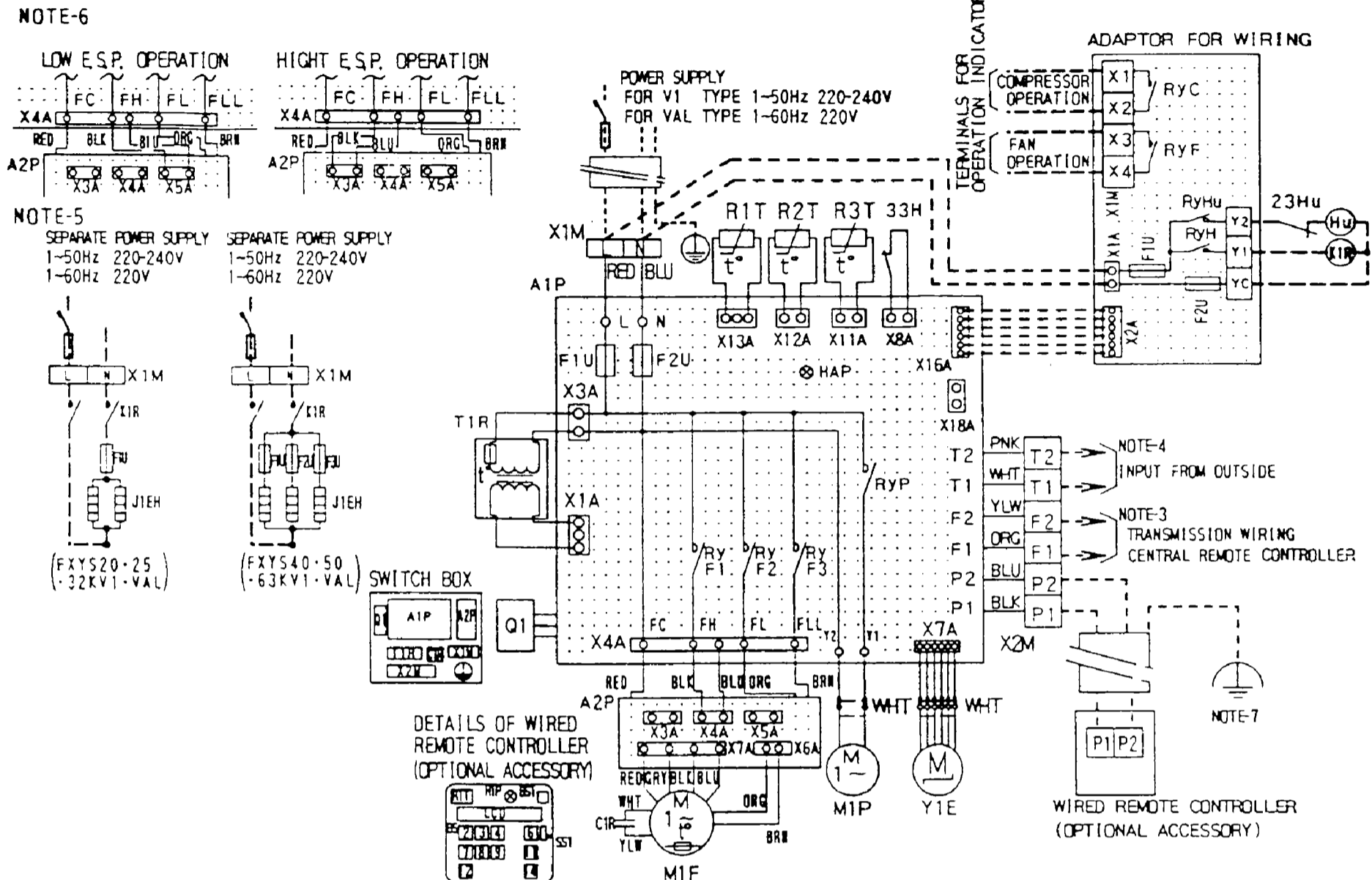

- NOTES)
1. □ □ □ □ , ● : TERMINAL, ○ ○ : CONNECTOR, — ○ : WIRE CLAMP
  2. - - - - : FIELD WIRING
  3. IN CASE USING CENTRAL REMOTE CONTROLLER, CONNECT IT TO THE UNIT IN ACCORDANCE WITH THE ATTACHED INSTRUCTION MANUAL.
  4. WHEN CONNECTING THE INPUT WIRES FROM OUTSIDE, FORCED OFF OR ON/OFF CONTROL OPERATION CAN BE SELECTED BY REMOTE CONTROLLER. IN DETAILS, REFER TO THE INSTALLATION MANUAL ATTACHED THE UNIT.
  5. IN CASE INSTALLING THE ELECTRIC HEATER, EXECUTE THE ADDITIONAL WIRING FOR HEATER CIRCUIT (KIR, J1EH). IN THIS CASE, THE MAIN POWER SUPPLY HAS TO BE SUPPLIED INDEPENDENTLY.
  6. IN CASE HIGH OR LOW E.S.P. OPERATION, CHANGE THE WIRING CONNECTION OF X4A AS SHOWN RIGHT FIGURE.
  7. GROUND THE SHIELD OF THE REMOTE CONTROLLER CORD TO THE INDOOR UNIT. (ELECTROMAGNETIC COMPATIBILITY TO THE ELECTRICAL APPLIANCE AND MATERIAL CONTROL LAW OF JAPAN, ALSO THE GROUNDING SHOWN IN THE FIGURE IS UNNECESSARY.)
  8. SYMBOLS SHOW AS FOLLOWS. (PNK:PINK WHT:WHITE YLW:YELLOW ORG:ORANGE BLU:BLUE BLK:BLACK RED:RED BRW:BROWN)
  9. USE COPPER CONDUCTORS ONLY.

33H	FLOAT SWITCH	X2M	TERMINAL STRIP(CONTROL)	BS7	PUSH BUTTON (TIMER ON/OFF)
A1P	PRINTED CIRCUIT BOARD	Y1E	ELECTRONIC EXPANSION VALVE	BS11	PUSH BUTTON (FAN SPEED)
A2P	TERMINAL BOARD	OPTIONAL PARTS		BS12	PUSH BUTTON (INSPECTION/TEST)
CIR	CAPACITOR(M1F)	23Hu	HUMIDISTAT	BS14	PUSH BUTTON (FILTER SIGN RESET)
F1T	THERMAL FUSE(152°C) (M1F EMBEDDED)	F1U-3U	FUSE(250V, 15A)	M1P	LIGHT EMISSION DIODE (ON-RED)
F1U-2U	FUSE(250V, 10A)	Hu	HUMIDIFIER	LCD	LIQUID CRYSTAL DISPLAY
HAP	LIGHT EMISSION DIODE (SERVICE MONITOR GREEN)	J1EH	ELECTRIC HEATER	R1T	THERMISTOR(AIR)
M1F	MOTOR(INDOOR FAN)	K1R	MAGNETIC RELAY(J1EH)	SS1	SELECTOR SWITCH(MAIN/SUB)
M1P	MOTOR(DRAIN PUMP)	X1M	TERMINAL STRIP(J1EH)		ADAPTOR FOR WIRING(KRP1861)
Q1	POWER TRANSISTOR	WIRED REMOTE CONTROLLER (BRC1A62)		F1U-2U	FUSE (250V, 5A)
R1T	THERMISTOR(AIR)	BS1	PUSH BUTTON(ON/OFF)	RYC	MAGNETIC RELAY
R2T-3T	THERMISTOR(COIL)	BS2	PUSH BUTTON	RYF	MAGNETIC RELAY
RYF1-3	MAGNETIC RELAY(M1F)	(TIMER MODE START/STOP)		RYH	MAGNETIC RELAY(J1EH)
RYP	MAGNETIC RELAY(M1P)	BS3-8	PUSH BUTTON (PROGRAMING TIME)	RYHU	MAGNETIC RELAY(Hu)
T1R	TRANSFORMER(220-240V/27V)	BS4-9	PUSH BUTTON (TEMPERATURE SET)		CONNECTOR FOR OPTIONAL PARTS
X1M	TERMINAL STRIP(POWER)			X16A	CONNECTOR(ADAPTOR FOR WIRING)
				X18A	CONNECTOR( WIRING ADAPTOR FOR ELECTRICAL APPENDICES)

# ■ Ceiling mounted cassette built-in type

## ● FXYS80K/100K/125KV1, VAL

NOTE-6

HIGHT E.S.P. OPERATION

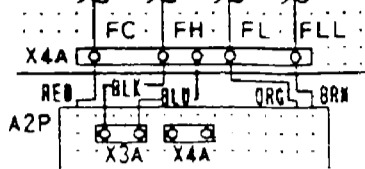

NOTE-5

SEPARATE POWER SUPPLY  
1-50Hz 220-240V  
1-60Hz 220V

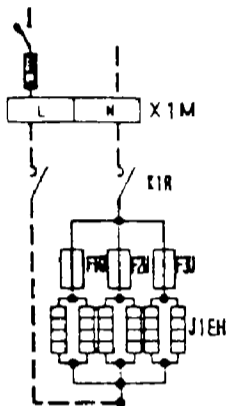

DETAILS OF WIRED  
REMOTE CONTROLLER  
(OPTIONAL ACCESSORY)

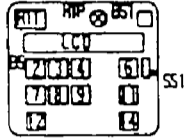

SWITCH BOX

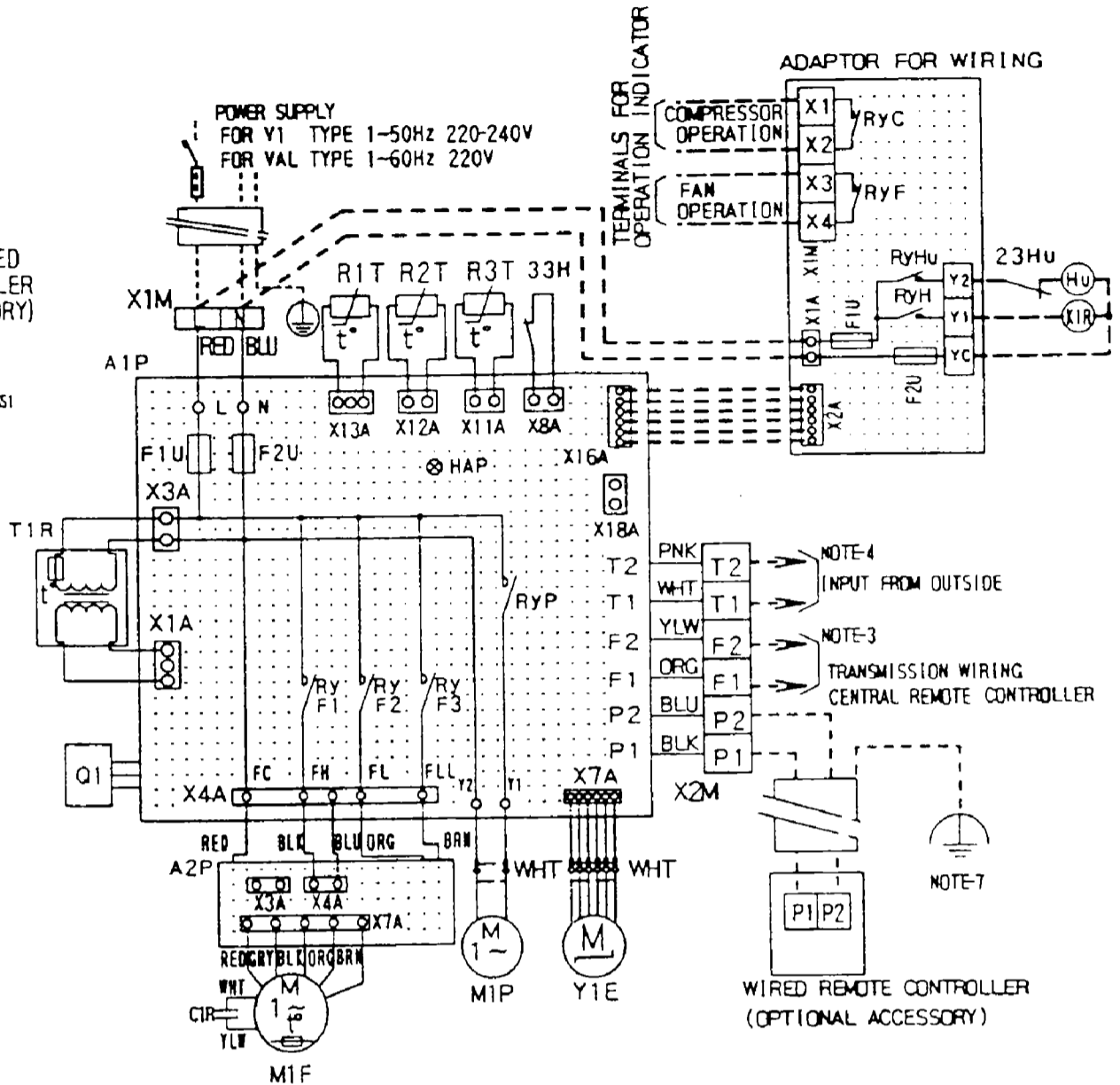
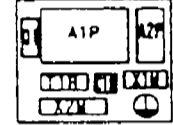

NOTES)

1. □ □ □ □, ● : TERMINAL □ □ □ □, ⊕ : CONNECTOR, ○ : WIRE CLAMP
2. - - - - : FIELD WIRING
3. IN CASE USING CENTRAL REMOTE CONTROLLER, CONNECT IT TO THE UNIT IN ACCORDANCE WITH THE ATTACHED INSTRUCTION MANUAL.
4. WHEN CONNECTING THE INPUT WIRES FROM OUTSIDE, FORCED OFF OR ON/OFF CONTROL OPERATION CAN BE SELECTED BY REMOTE CONTROLLER. IN DETAILS, REFER TO THE INSTALLATION MANUAL ATTACHED THE UNIT.
5. IN CASE INSTALLING THE ELECTRIC HEATER, EXECUTE THE ADDITIONAL WIRING FOR HEATER CIRCUIT (K1R, J1EH). IN THIS CASE, THE MAIN POWER SUPPLY HAS TO BE SUPPLIED INDEPENDENTLY.
6. IN CASE HIGH E.S.P. OPERATION, CHANGE THE WIRING CONNECTION OF X4A AS SHOWN RIGHT FIGURE.
7. GROUND THE SHIELD OF THE REMOTE CONTROLLER CORD TO THE INDOOR UNIT. (ELECTROMAGNETIC COMPATIBILITY TO THE ELECTRICAL APPLIANCE AND MATERIAL CONTROL LAW OF JAPAN, ALSO THE GROUNDING SHOWN IN THE FIGURE IS UNNECESSARY.)
8. SYMBOLS SHOW AS FOLLOWS. (PNK:PINK WHT:WHITE YLW:YELLOW ORG:ORANGE BLU:BLUE BLK:BLACK RED:RED BRW:BROWN)
9. USE COPPER CONDUCTORS ONLY.

33H	FLOAT SWITCH	X2M	TERMINAL STRIP (CONTROL)	BS7	PUSH BUTTON (TIMER ON/OFF)
A1P	PRINTED CIRCUIT BOARD	Y1E	ELECTRONIC EXPANSION VALVE	BS11	PUSH BUTTON (FAN SPEED)
A2P	TERMINAL BOARD	OPTIONAL PARTS		BS12	PUSH BUTTON (INSPECTION/TEST)
C1R	CAPACITOR (M1F)	23Hu	HUMIDISTAT	BS14	PUSH BUTTON (FILTER SIGN RESET)
F1T	THERMAL FUSE (152°C) (M1F EMBEDDED)	F1U-3U	FUSE (250V, 15A)	H1P	LIGHT EMISSION DIODE (ON-RED)
F1U-2U	FUSE (250V, 10A)	Hu	HUMIDIFIER	LCD	LIQUID CRYSTAL DISPLAY
J1EH	ELECTRIC HEATER	J1EH	ELECTRIC HEATER	R1T	THERMISTOR (AIR)
HAP	LIGHT EMISSION DIODE (SERVICE MONITOR GREEN)	K1R	MAGNETIC RELAY (J1EH)	SS1	SELECTOR SWITCH (MAIN/SUB)
M1F	MOTOR (INDOOR FAN)	X1M	TERMINAL STRIP (J1EH)	ADAPTOR FOR WIRING (KRP1861)	
M1P	MOTOR (DRAIN PUMP)	WIRED REMOTE CONTROLLER (BRC1A62)		F1U-2U	FUSE (250V, 5A)
Q1	POWER TRANSISTOR	BS1	PUSH BUTTON (ON/OFF)	RyC	MAGNETIC RELAY
R1T	THERMISTOR (AIR)	BS2	PUSH BUTTON (TIMER MODE START/STOP)	RyF	MAGNETIC RELAY
R2T-3T	THERMISTOR (COIL)	BS3-8	PUSH BUTTON (PROGRAMING TIME)	RyH	MAGNETIC RELAY (J1EH)
RyF1-3	MAGNETIC RELAY (M1F)	BS4-9	PUSH BUTTON (TEMPERATURE SET)	RyHu	MAGNETIC RELAY (Hu)
RyP	MAGNETIC RELAY (M1P)			CONNECTOR FOR OPTIONAL PARTS	
T1R	TRANSFORMER (220-240V/27V)	X16A	CONNECTOR (ADAPTOR FOR WIRING)	X16A	CONNECTOR (ADAPTOR FOR WIRING)
X1M	TERMINAL STRIP (POWER)	X18A	CONNECTOR (WIRING ADAPTOR FOR ELECTRICAL APPLIANCES)	X18A	CONNECTOR (WIRING ADAPTOR FOR ELECTRICAL APPLIANCES)

## Ceiling mounted duct type

### ● FXYM40K/50K/63K/80K/100K/125KVE

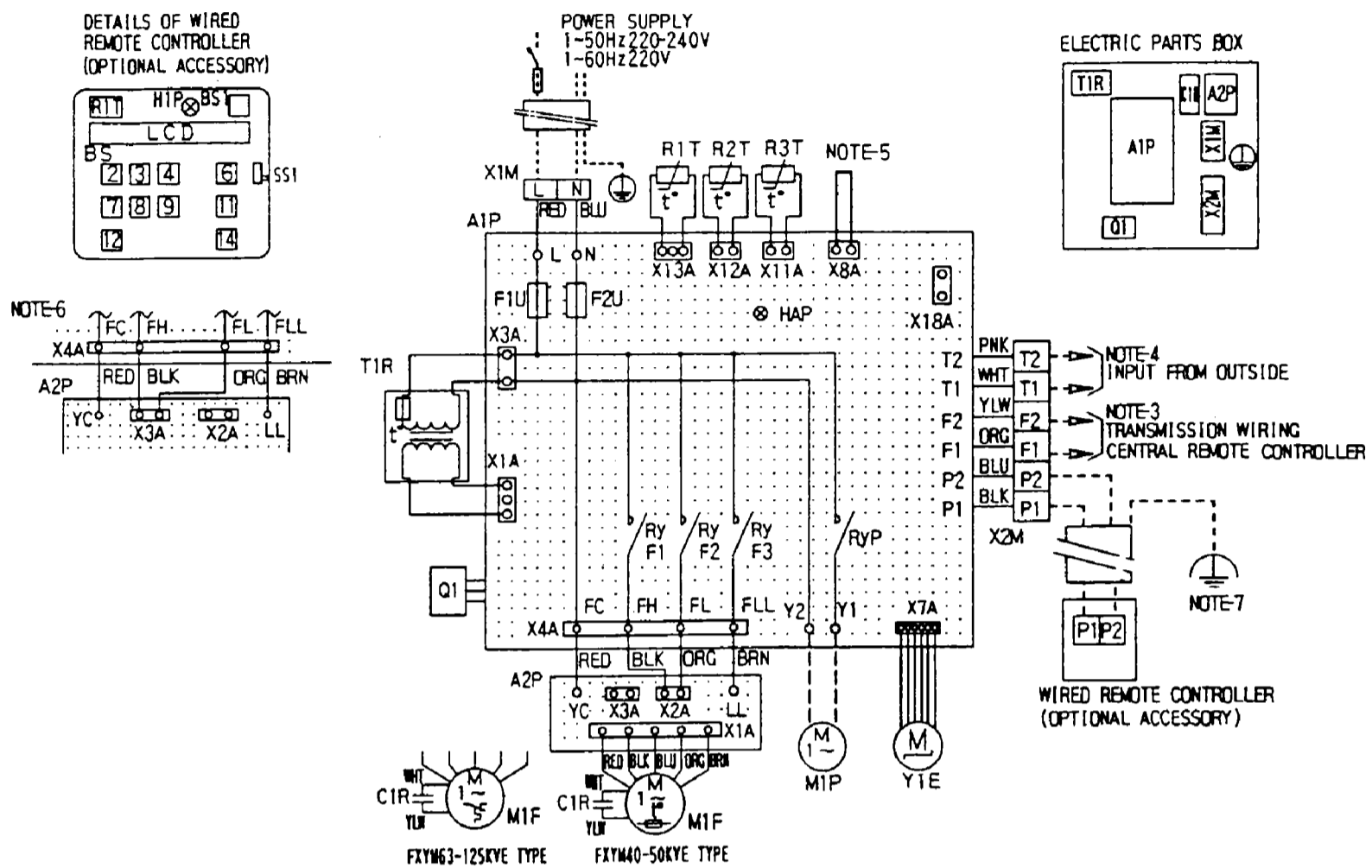

#### NOTES)

1. : TERMINAL, : CONNECTOR, : WIRE CLAMP  
 : JUMPER CONNECTOR
2. - - - - : FIELD WIRING
3. IN CASE USING CENTRAL REMOTE CONTROLLER, CONNECT IT TO THE UNIT IN ACCORDANCE WITH THE ATTACHED INSTRUCTION MANUAL.
4. WHEN CONNECTING THE INPUT WIRES FROM OUTSIDE, FORCED OFF OR ON/OFF CONTROL OPERATION CAN BE SELECTED BY REMOTE CONTROLLER IN DETAILS, REFER TO THE INSTALLATION MANUAL ATTACHED THE UNIT.
5. IN CASE INSTALLING THE DRAIN PUMP, REMOVE THE JUMPER AND EXECUTE THE ADDITIONAL WIRING FOR FLOAT SWITCH(33H).
6. IN CASE HIGH E.S.P. OPERATION, CHANGE THE WIRING CONNECTION OF X2A AS SHOWN UPPER FIGURE.
7. GROUND THE SHIELD OF THE REMOTE CONTROLLER CORD TO THE INDOOR UNIT. (ELECTROMAGNETIC COMPATIBILITY TO THE ELECTRICAL APPLIANCE AND MATERIAL CONTROL LAW OF JAPAN, ALSO THE GROUNDING SHOWN IN THE FIGURE IS UNNECESSARY.)
8. SYMBOLS SHOW AS FOLLOWS, (PNK:PINK WHT:WHITE YLW:YELLOW ORG:ORANGE BLU:BLUE BLK:BLACK RED:RED BRN:BROWN)
9. USE COPPER CONDUCTORS ONLY.

A1P	PRINTED CIRCUIT BOARD	X1M	TERMINAL STRIP(POWER)	BS11	PUSH BUTTON(FAN SPEED)
A2P	TERMINAL BOARD	X2M	TERMINAL STRIP(CONTROL)	BS12	PUSH BUTTON (INSPECTION/TEST)
C1R	CAPACITOR (M1F)	Y1E	ELECTRONIC EXPANSION VALVE	BS14	PUSH BUTTON (FILTER SIGN RESET)
F1T	THERMAL FUSE(153°C) (M1F EMBEDDED ONLY 40-50 TYPE)		OPTIONAL PARTS		
F1U-2U	FUSE (250V, 10A)	M1P	MOTOR (DRAIN PUMP)	H1P	LIGHT EMISSION DIODE (ON-RED)
HAP	LIGHT EMISSION DIODE (SERVICE MONITOR-GREEN)		WIRED REMOTE CONTROLLER(BRIC1A62)	LCD	LIQUID CRYSTAL DISPLAY
M1F	MOTOR (INDOOR FAN)	BS2	PUSH BUTTON (TIMER MODE START/STOP)	SS1	SELECTOR SWITCH (MAIN/SUB)
Q1	POWER TRANSISTOR			R1T	THERMISTOR(AIR)
Q1F	THERMO SWITCH(M1F EMBEDDED ONLY 63-125 TYPE)	BS3-8	PUSH BUTTON (PROGRAMMING TIME)		CONNECTOR FOR OPTIONAL PARTS
R1T	THERMISTOR(AIR)	BS4-9	PUSH BUTTON (TEMPERATURE SET)	X8A	CONNECTOR(FLOAT SWITCH)
R2T-3T	THERMISTOR(COIL)			X18A	CONNECTOR(WIRING ADAPTOR FOR ELECTRICAL APPENDICES)
RYF1-3	MAGNETIC RELAY(M1F)	BS6	PUSH BUTTON (MODE SELECTOR)		
RYP	MAGNETIC RELAY(M1P)				
T1R	TRANSFORMER(220-240V/27V)	BS7	PUSH BUTTON (TIMER ON/OFF)		

● FXYM200K/250KVE

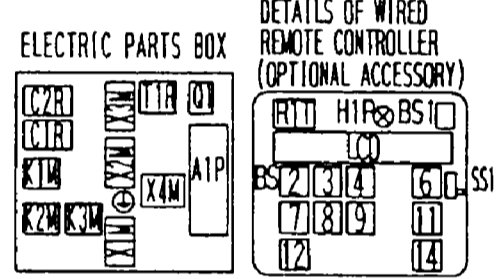
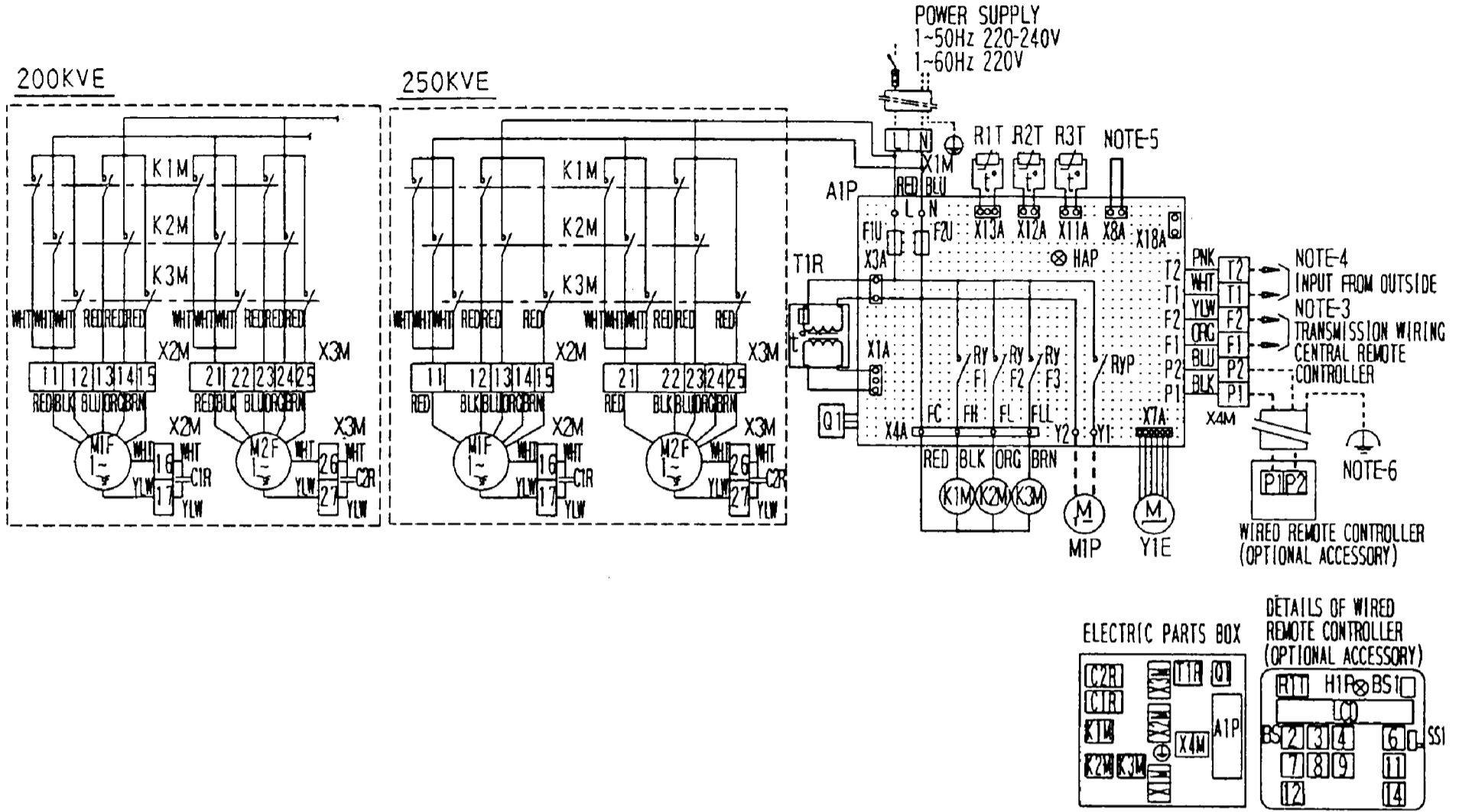

- NOTES)
1. : TERMINAL : CONNECTOR : WIRE CLAMP : JUMPER CONNECTOR
  2. - - - - : FIELD WIRING
  3. IN CASE USING CENTRAL REMOTE CONTROLLER, CONNECT IT TO THE UNIT IN ACCORDANCE WITH THE ATTACHED INSTRUCTION MANUAL.
  4. WHEN CONNECTING THE INPUT WIRES FROM OUTSIDE, FORCED OFF OR ON/OFF CONTROL OPERATION CAN BE SELECTED BY REMOTE CONTROLLER IN DETAILS, REFER TO THE INSTALLATION MANUAL ATTACHED THE UNIT.
  5. IN CASE INSTALLING THE DRAIN PUMP, REMOVE THE JUMPER AND EXECUTE 33H THE ADDITIONAL WIRING FOR FLOAT SWITCH(33H).
  6. GROUND THE SHIELD OF THE REMOTE CONTROLLER CORD TO THE INDOOR UNIT, (ELECTROMAGNETIC COMPATIBILITY TO THE ELECTRICAL APPLIANCE AND MATERIAL CONTROL LAW OF JAPAN, ALSO THE GROUNDING SHOWN IN THE FIGURE IS UNNECESSARY.)
  7. SYMBOLS SHOW AS FOLLOWS. (PNK:PINK WHT:WHITE YLW:YELLOW ORG:ORANGE BLU:BLUE BLK:BLACK RED:RED BRN:BROWN)
  8. USE COPPER CONDUCTORS ONLY.

A1P PRINTED CIRCUIT BOARD	BS1 PUSH BUTTON(ON/OFF)
C1R-2R CAPACITOR (M1F-2F)	BS2 PUSH BUTTON (TIMER MODE START/STOP)
F1U-2U FUSE (250V, 10A)	BS3-8 PUSH BUTTON (PROGRAMING TIME)
HAP LIGHT EMISSION DIODE (SERVICE MONITOR-GREEN)	BS4-9 PUSH BUTTON (TEMPERATURE SET)
K1M MAGNETIC CONTACTOR(M1F-2F)	BS6 PUSH BUTTON(MODE SELECTOR)
K2M MAGNETIC CONTACTOR(M1F-2F)	BS7 PUSH BUTTON(TIMER ON/OFF)
K3M MAGNETIC CONTACTOR(M1F-2F)	BS11 PUSH BUTTON(FAN SPEED)
M1F-2F MOTOR (INDOOR FAN)	BS12 PUSH BUTTON (INSPECTION/TEST)
Q1 POWER TRANSISTOR	BS14 PUSH BUTTON (FILTER SIGN RESET)
T1F THERMO SWITCH (M1F-2F EMBEDDED)	H1P LIGHT EMISSION DIODE(OH-RED)
R1T THERMISTOR(AIR)	LCD LIQUID CRYSTAL DISPLAY
R2T-3T THERMISTOR(COIL)	R1T THERMISTOR(AIR)
R1F-F3 MAGNETIC RELAY(M1F-2F)	SS1 SELECTOR SWITCH(WAIV/SUB)
R2F MAGNETIC RELAY(M1P)	CONNECTOR FOR OPTIONAL PARTS
T1R TRANSFORMER(220-240V/27V)	X8A CONNECTOR(FLOAT SWITCH)
X1M TERMINAL STRIP(POWER)	X18A CONNECTOR(WIRING ADAPTOR FOR ELECTRICAL APPENDICES)
X2M-4M TERMINAL STRIP(CONTROL)	
Y1E ELECTRONIC EXPANSION VALVE	
OPTIONAL PARTS	
M1P MOTOR (DRAIN PUMP)	
WIRED REMOTE CONTROLLER (BRC1A62)	

# ■ Ceiling suspended type

## ● FXYH32K/63K/100KVE

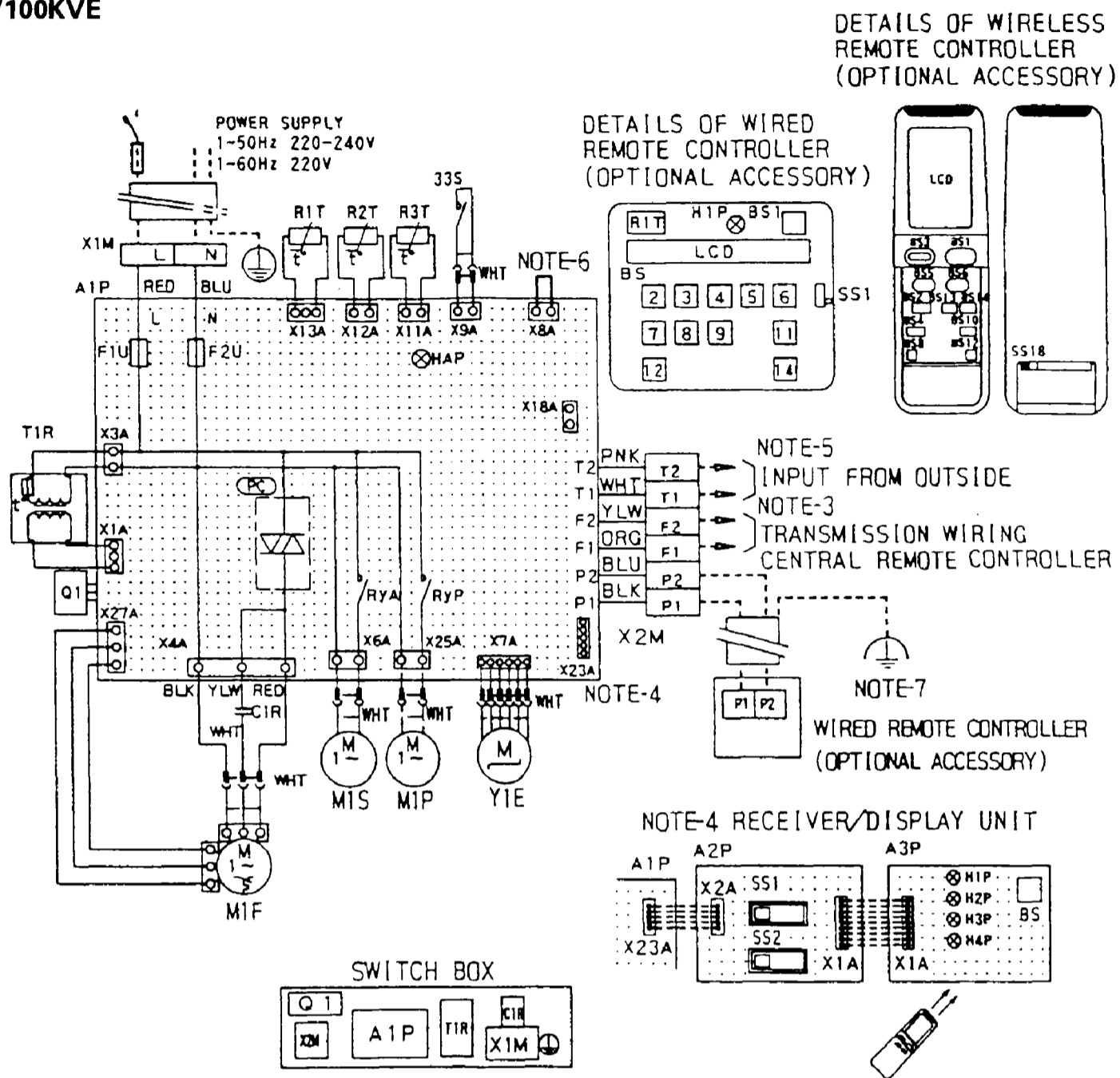

33S		LIMIT SWITCH(SWING FLAP)	LCD	LIQUID CRYSTAL DISPLAY	CONNECTOR FOR OPTIONAL PARTS	
A1P	PRINTED CIRCUIT BOARD	R1T	THERMISTOR(AIR)	X8A	CONNECTOR(FLOAT SWITCH)	
C1R	CAPACITOR(M1F)	SS1	SELECTOR SWITCH(MAIN/SUB)	X18A	CONNECTOR(WIRING ADAPTOR FOR ELECTRICAL APPENDICES)	
F1U·2U	FUSE(250V,5A)	WIRELESS REMOTE CONTROLLER(BRC7A63W-68W)			X23A	CONNECTOR(WIRELESS REMOTE CONTROLLER)
HAP	LIGHT EMISSION DIODE (SERVICE MONITOR-GREEN)	BS1	PUSH BUTTON(ON/OFF)			
M1F	MOTOR (INDOOR FAN)	BS2	PUSH BUTTON (TIMER MODE START/STOP)			
M1S	MOTOR (SWING FLAP)	BS3	PUSH BUTTON(FAN SPEED)			
Q1	POWER TRANSISTOR	BS4	PUSH BUTTON(AIR FLOW DIRECTION ADJUST)			
Q1F	THERMO SWITCH(M1F EMBEDDED)	BS5·6	PUSH BUTTON (TIME/TEMPERATURE SET)			
R1T	THERMISTOR(AIR)	BS8	PUSH BUTTON (INSPECTION/TEST)			
R2T·3T	THERMISTOR(COIL)	BS10	PUSH BUTTON (MODE SELECTOR)			
RYA	MAGNETIC RELAY(M1S)	BS12	PUSH BUTTON (FILTER SIGN RESET)			
RYP	MAGNETIC RELAY(M1P)	BS13	PUSH BUTTON(TIMER ON)			
T1R	TRANSFORMER(220-240V/27V)	BS14	PUSH BUTTON(TIMER OFF)			
X1M	TERMINAL STRIP(POWER)	LCD	LIQUID CRYSTAL DISPLAY			
X2M	TERMINAL STRIP(CONTROL)	SS18	SELECTOR SWITCH (WIRELESS ADDRESS SET)			
Y1E	ELECTRONIC EXPANSION VALVE	RECEIVER/DISPLAY UNIT(ATTACHED TO WIRELESS REMOTE CONTROLLER)				
(PC)	PHASE CONTROL CIRCUIT	A2P	PRINTED CIRCUIT BOARD			
OPTIONAL PARTS		A3P	PRINTED CIRCUIT BOARD			
M1P	MOTOR (DRAIN PUMP)	BS	PUSH BUTTON(ON/OFF)			
WIRELESS REMOTE CONTROLLER (BRC1A61)		H1P	LIGHT EMISSION DIODE (ON-RED)			
BS1	PUSH BUTTON(ON/OFF)	H2P	LIGHT EMISSION DIODE (TIMER-GREEN)			
BS2	PUSH BUTTON (TIMER MODE START/STOP)	H3P	LIGHT EMISSION DIODE (FILTER SIGN-RED)			
BS3·8	PUSH BUTTON (PROGRAMMING TIME)	H4P	LIGHT EMISSION DIODE (DEFROST-ORANGE)			
BS4·9	PUSH BUTTON (TEMPERATURE SET)	SS1	SELECTOR SWITCH (MAIN/SUB)			
BS5	PUSH BUTTON(AIR FLOW DIRECTION ADJUST)	SS2	SELECTOR SWITCH (WIRELESS ADDRESS SET)			
BS6	PUSH BUTTON(MODE SELECTOR)					
BS7	PUSH BUTTON(TIMER ON/OFF)					
BS11	PUSH BUTTON(FAN SPEED)					
BS12	PUSH BUTTON (INSPECTION/TEST)					
BS14	PUSH BUTTON (FILTER SIGN RESET)					
H1P	LIGHT EMISSION DIODE (ON-RED)					

### NOTES)

1. : TERMINAL : CONNECTOR : JUMPER CONNECTOR
2. ---- : FIELD WIRING
3. IN CASE USING CENTRAL REMOTE CONTROLLER, CONNECT IT TO THE UNIT IN ACCORDANCE WITH THE ATTACHED INSTRUCTION MANUAL.
4. X23A IS CONNECTED WHEN THE WIRELESS REMOTE CONTROLLER KIT (BRC7A63W-68W) IS BEING USED.
5. WHEN CONNECTING THE INPUT WIRES FROM OUTSIDE, FORCED OFF OR ON/OFF CONTROL OPERATION CAN BE SELECTED BY REMOTE CONTROLLER MANUAL. IN DETAILS, REFER TO THE INSTALLATION MANUAL ATTACHED THE UNIT.
6. IN CASE INSTALLING THE DRAIN PUMP, REMOVE THE JUMPER CONNECTOR OF X8A AND EXECUTE THE ADDITIONAL WIRING FOR FLOAT SWITCH AND DRAIN PUMP. (DRAIN PUMP KIT IS OPTIONAL ACCESSORY ONLY FOR THE 60Hz 220V POWER SUPPLY.)
7. GROUND THE SHIELD OF THE REMOTE CONTROLLER CORD TO THE INDOOR UNIT. (ELECTROMAGNETIC COMPATIBILITY TO THE ELECTRICAL APPLIANCE AND MATERIAL CONTROL LAW OF JAPAN, ALSO THE GROUNDING SHOWN IN THE FIGURE IS UNNECESSARY.)
8. SYMBOLS SHOW AS FOLLOWS, (PNK:PINK WHT:WHITE YLW:YELLOW ORG:ORANGE) (BLU:BLUE BLK:BLACK RED:RED)
9. USE COPPER CONDUCTORS ONLY.



# Wall mounted type

## FXYA25K/32K/40K/50K/63KVE

POWER SUPPLY  
1-50Hz: 220-240V  
1-60Hz: 220V

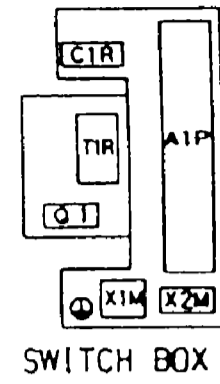
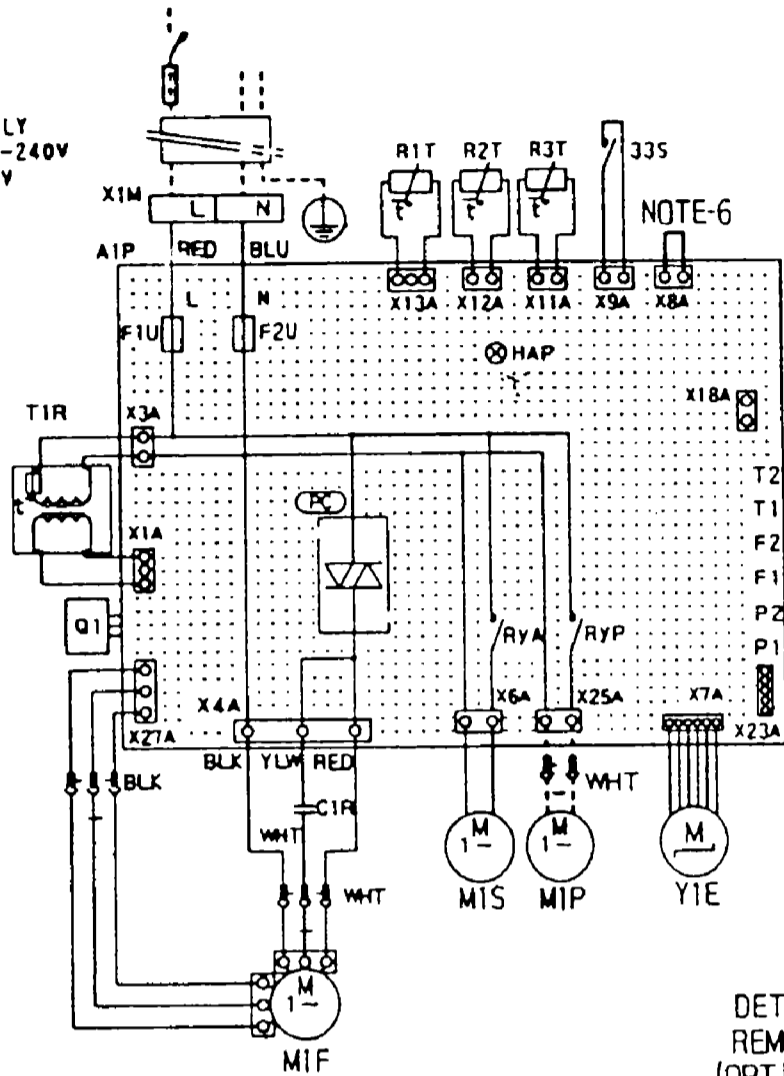

DETAILS OF WIRELESS REMOTE CONTROLLER (OPTIONAL ACCESSORY)

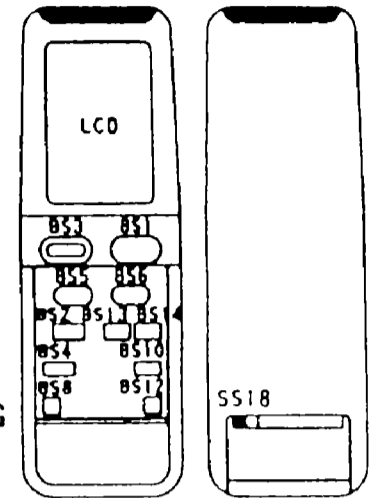

NOTE-5  
INPUT FROM OUTSIDE  
TRANSMISSION WIRING  
CENTRAL REMOTE  
CONTROLLER

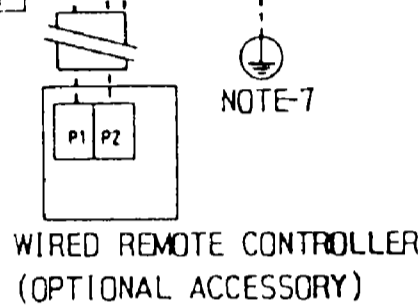

DETAILS OF WIRED REMOTE CONTROLLER (OPTIONAL ACCESSORY)

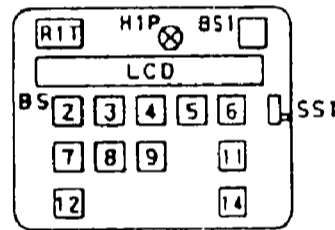

NOTE-4 RECEIVER/DISPLAY UNIT

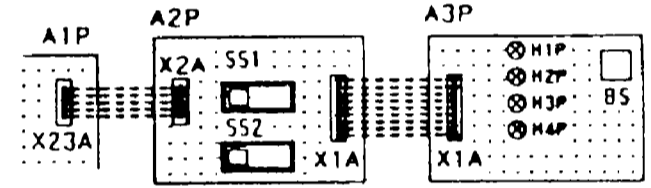

33S	LIMIT SWITCH(SWING FLAP)	LCD	LIQUID CRYSTAL DISPLAY	CONNECTOR FOR OPTIONAL PARTS		
A1P	PRINTED CIRCUIT BOARD	R1T	THERMISTOR(AIR)	X8A	CONNECTOR(FLOAT SWITCH)	
C1R	CAPACITOR(MIF)	SS1	SELECTOR SWITCH(MAIN/SUB)	X18A	CONNECTOR(WIRING ADAPTOR FOR ELECTRICAL APPENDICES)	
F1U·2U	FUSE(250V,5A)	WIRELESS REMOTE CONTROLLER (BRC7A64W)			X23A	CONNECTOR(WIRELESS REMOTE CONTROLLER)
HAP	LIGHT EMISSION DIODE (SERVICE MONITOR-GREEN)	BS1	PUSH BUTTON(ON/OFF)			
M1F	MOTOR(INDOOR FAN)	BS2	PUSH BUTTON (TIMER MODE START/STOP)			
M1S	MOTOR(SWING FLAP)	BS3	PUSH BUTTON(FAN SPEED)			
Q1	POWER TRANSISTOR	BS4	PUSH BUTTON(AIR FLOW DIRECTION ADJUST)			
R1T	THERMISTOR(AIR)	BS5·6	PUSH BUTTON (TIME/TEMPERATURE SET)			
R2T·3T	THERMISTOR(COIL)	BS8	PUSH BUTTON (INSPECTION/TEST)			
RYA	MAGNETIC RELAY(MIS)	BS10	PUSH BUTTON (MODE SELECTOR)			
RYP	MAGNETIC RELAY(MIP)	BS12	PUSH BUTTON (FILTER SIGN RESET)			
T1R	TRANSFORMER(220-240V/27V)	BS13	PUSH BUTTON(TIMER ON)			
X1M	TERMINAL STRIP(POWER)	BS14	PUSH BUTTON(TIMER OFF)			
X2M	TERMINAL STRIP(CONTROL)					
Y1E	ELECTRONIC EXPANSION VALVE	LCD	LIQUID CRYSTAL DISPLAY			
(PC)	PHASE CONTROL CIRCUIT	SS18	SELECTOR SWITCH (WIRELESS ADDRESS SET)			
OPTIONAL PARTS		RECEIVER/DISPLAY UNIT(ATTACHED TO WIRELESS REMOTE CONTROLLER)				
M1P	MOTOR(DRAIN PUMP)	A2P	PRINTED CIRCUIT BOARD			
WIRED REMOTE CONTROLLER (BRC1051)		A3P	PRINTED CIRCUIT BOARD			
BS1	PUSH BUTTON(ON/OFF)	BS	PUSH BUTTON(ON/OFF)			
BS2	PUSH BUTTON (TIMER MODE START/STOP)	H1P	LIGHT EMISSION DIODE (ON-RED)			
BS3·8	PUSH BUTTON (PROGRAMING TIME)	H2P	LIGHT EMISSION DIODE (TIMER-GREEN)			
BS4·9	PUSH BUTTON (TEMPERATURE SET)	H3P	LIGHT EMISSION DIODE (FILTER SIGN-RED)			
BS5	PUSH BUTTON(AIR FLOW DIRECTION ADJUST)	H4P	LIGHT EMISSION DIODE (DEFROST-ORANGE)			
BS6	PUSH BUTTON(MODE SELECTOR)					
BS7	PUSH BUTTON(TIMER ON/OFF)					
BS11	PUSH BUTTON(FAN SPEED)					
BS12	PUSH BUTTON (INSPECTION/TEST)					
BS14	PUSH BUTTON (FILTER SIGN RESET)	SS1	SELECTOR SWITCH (MAIN/SUB)			
H1P	LIGHT EMISSION DIODE (ON-RED)	SS2	SELECTOR SWITCH (WIRELESS ADDRESS SET)			

### NOTES

- : TERMINAL ○○, ⊕, ⊖ : CONNECTOR □□ : CONNECTOR
- : FIELD WIRING
- IN CASE USING CENTRAL REMOTE CONTROLLER, CONNECT IT TO THE UNIT IN ACCORDANCE WITH THE ATTACHED INSTRUCTION MANUAL.
- X23A IS CONNECTED WHEN THE WIRELESS REMOTE CONTROLLER KIT (BRC7A64W) IS BEING USED.
- WHEN CONNECTING THE INPUT WIRES FROM OUTSIDE, FORCED OFF OR ON/OFF CONTROL OPERATION CAN BE SELECTED BY REMOTE CONTROLLER MANUAL. IN DETAILS, REFER TO THE INSTALLATION MANUAL ATTACHED THE UNIT.
- IN CASE INSTALLING THE DRAIN PUMP, REMOVE THE JUMPER CONNECTOR OF X8A AND EXECUTE THE ADDITIONAL WIRING FOR FLOAT SWITCH AND DRAIN PUMP. (DRAIN PUMP KIT IS OPTIONAL ACCESSORY) (ONLY FOR THE 60Hz 220V POWER SUPPLY.)
- GROUND THE SHIELD OF THE REMOTE CONTROLLER CORD TO THE INDOOR UNIT. (ELECTROMAGNETIC COMPATIBILITY TO THE ELECTRICAL APPLIANCE AND MATERIAL CONTROL LAW OF JAPAN, ALSO THE GROUNDING SHOWN IN THE FIGURE IS UNNECESSARY.)

■ Floor standing type / Concealed floor standing type

● FXYL (M) 25K/40K/63KV1, VAL

DETAILS OF WIRED  
REMOTE CONTROLLER  
(OPTIONAL ACCESSORY)

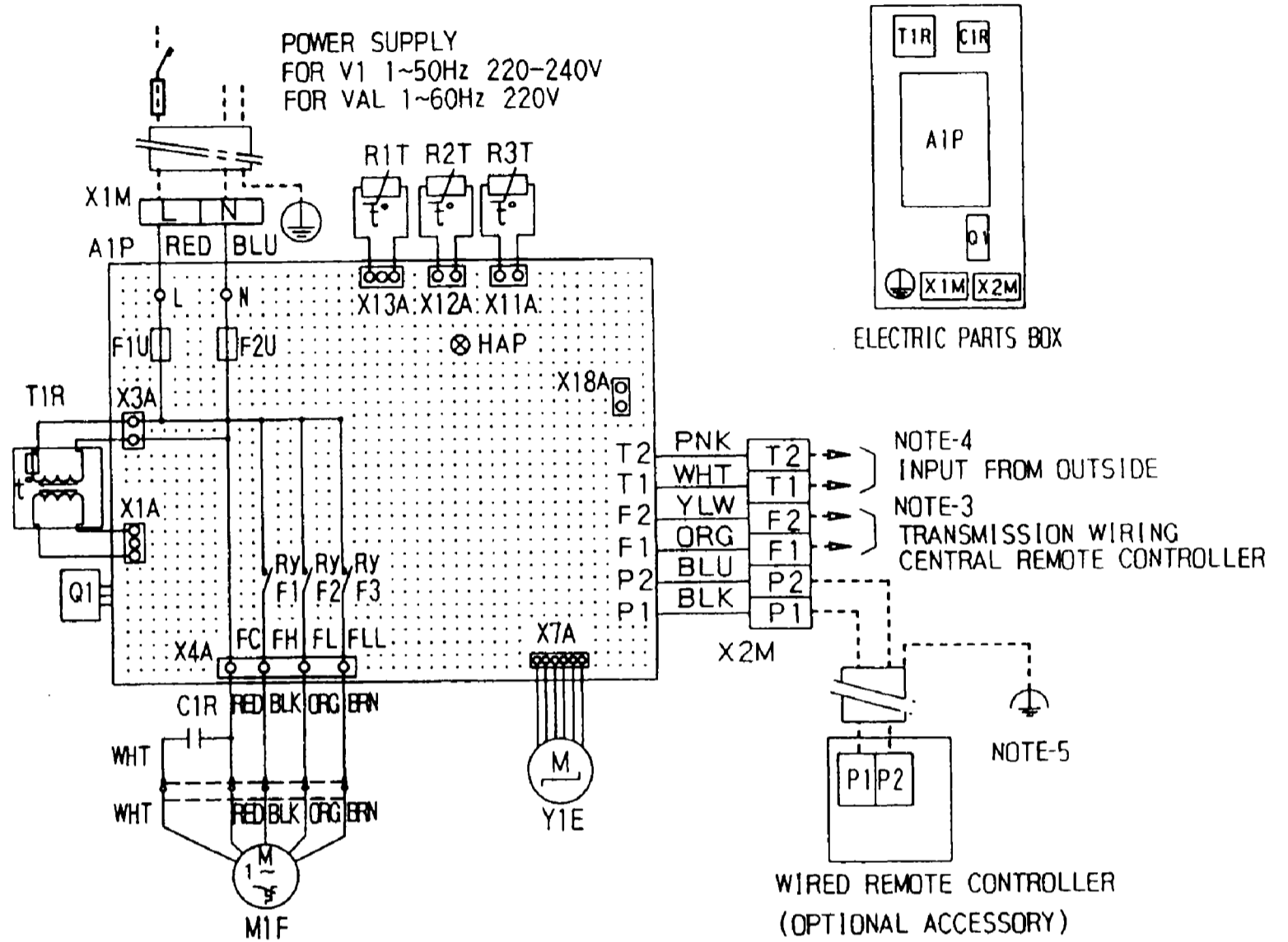
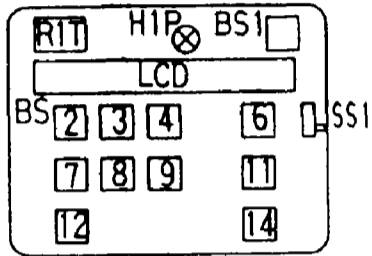

NOTES)

1. □□□□: TERMINAL, ⊞, ⊚: CONNECTOR, ○-○: WIRE CLAMP
2. ----: FIELD WIRING
3. IN CASE USING CENTRAL REMOTE CONTROLLER, CONNECT IT TO THE UNIT IN ACCORDANCE WITH THE ATTACHED INSTRUCTION MANUAL.
4. WHEN CONNECTING THE INPUT WIRES FROM OUTSIDE, FORCED OFF OR ON/OFF CONTROL OPERATION CAN BE SELECTED BY REMOTE CONTROLLER, IN DETAILS, REFER TO THE INSTALLATION MANUAL ATTACHED THE UNIT.
5. GROUND THE SHIELD OF THE REMOTE CONTROLLER CORD TO THE INDOOR UNIT.  
(ELECTROMAGNETIC COMPATIBILITY TO THE ELECTRICAL APPLIANCE AND MATERIAL CONTROL)  
(LAW OF JAPAN, ALSO THE GROUNDING SHOWN IN THE FIGURE IS UNNECESSARY.)
6. SYMBOLS SHOW AS FOLLOWS. (PNK: PINK WHT: WHITE YLW: YELLOW ORG: ORANGE  
BLU: BLUE BLK: BLACK RED: RED BRN: BROWN)
7. USE COPPER CONDUCTORS ONLY.

A1P	PRINTED CIRCUIT BOARD	BS2	PUSH BUTTON (TIMER MODE START/STOP)	CONNECTOR FOR OPTIONAL PARTS
C1R	CAPACITOR (MIF)	BS3-8	PUSH BUTTON (PROGRAMING TIME)	X18A CONNECTOR(WIRING ADAPTOR FOR ELECTRICAL APPENDICES)
F1U-2U	FUSE (250V,5A)	BS4-9	PUSH BUTTON (TEMPERATURE SET)	
HAP	LIGHT EMISSION DIODE (SERVICE MONITOR-GREEN)	BS6	PUSH BUTTON (MODE SELECTOR)	
M1F	MOTOR (INDOOR FAN)	BS7	PUSH BUTTON (TIMER ON/OFF)	
Q1	POWER TRANSISTOR	BS11	PUSH BUTTON (FAN SPEED)	
Q1F	THERMO SWITCH (MIF EMBEDDED)	BS12	PUSH BUTTON (INSPECTION/TEST)	
R1T	THERMISTOR(AIR)	BS14	PUSH BUTTON (FILTER SIGN RESET)	
R2T-3T	THERMISTOR(COIL)	H1P	LIGHT EMISSION DIODE (ON-RED)	
RyF1-3	MAGNETIC RELAY(MIF)	LCD	LIQUID CRYSTAL DISPLAY	
T1R	TRANSFORMER(220-240V/27V)	R1T	THERMISTOR(AIR)	
X1M	TERMINAL STRIP(POWER)	SS1	SELECTOR SWITCH (MAIN/SUB)	
X2M	TERMINAL STRIP(CONTROL)			
Y1E	ELECTRONIC EXPANSION VALVE			
WIRED REMOTE CONTROLLER (EPC1A62)				
BS1	PUSH BUTTON (ON/OFF)			

## 2. Thermistor resistance / Temperature Characteristics

Indoor unit .....	For air suction	R1T	) For header	R6T
	For liquid pipe	R2T		
	For gas pipe	R3T		
Outdoor unit ...	For outdoor air	R1T		
	For coil	R2T		
	For suction pipe	R4T		
	For oil	R5T		

(kΩ)

T°C	0.0	0.5	T°C	0.0	0.5
-20	197.81	192.08	30	16.10	15.76
-19	186.53	181.16	31	15.43	15.10
-18	175.97	170.94	32	14.79	14.48
-17	166.07	161.36	33	14.18	13.88
-16	156.80	152.38	34	13.59	13.31
-15	148.10	143.96	35	13.04	12.77
-14	139.94	136.05	36	12.51	12.25
-13	132.28	128.63	37	12.01	11.76
-12	125.09	121.66	38	11.52	11.29
-11	118.34	115.12	39	11.06	10.84
-10	111.99	108.96	40	10.63	10.41
-9	106.03	103.18	41	10.21	10.00
-8	100.41	97.73	42	9.81	9.61
-7	95.14	92.61	43	9.42	9.24
-6	90.17	87.79	44	9.06	8.88
-5	85.49	83.25	45	8.71	8.54
-4	81.08	78.97	46	8.37	8.21
-3	76.93	74.94	47	8.05	7.90
-2	73.01	71.14	48	7.75	7.60
-1	69.32	67.56	49	7.46	7.31
0	65.84	64.17	50	7.18	7.04
1	62.54	60.96	51	6.91	6.78
2	59.43	57.94	52	6.65	6.53
3	56.49	55.08	53	6.41	6.53
4	53.71	52.38	54	6.65	6.53
5	51.09	49.83	55	6.41	6.29
6	48.61	47.42	56	6.18	6.06
7	46.26	45.14	57	5.95	5.84
8	44.05	42.98	58	5.74	5.43
9	41.95	40.94	59	5.14	5.05
10	39.96	39.01	60	4.96	4.87
11	38.08	37.18	61	4.79	4.70
12	36.30	35.45	62	4.62	4.54
13	34.62	33.81	63	4.46	4.38
14	33.02	32.25	64	4.30	4.23
15	31.50	30.77	65	4.16	4.08
16	30.06	29.37	66	4.01	3.94
17	28.70	28.05	67	3.88	3.81
18	27.41	26.78	68	3.75	3.68
19	26.18	25.59	69	3.62	3.56
20	25.01	24.45	70	3.50	3.44
21	23.91	23.37	71	3.38	3.32
22	22.85	22.35	72	3.27	3.21
23	21.85	21.37	73	3.16	3.11
24	20.90	20.45	74	3.06	3.01
25	20.00	19.56	75	2.96	2.91
26	19.14	18.73	76	2.86	2.82
27	18.32	17.93	77	2.77	2.72
28	17.54	17.17	78	2.68	2.64
29	16.80	16.45	79	2.60	2.55
30	16.10	15.76	80	2.51	2.47

Outdoor thermistors for discharge pipe (R3T, R3-1T, R3-2T)

(kΩ)

T°C	0.0	0.5	T°C	0.0	0.5	T°C	0.0	0.5
0	640.44	624.65	50	72.32	70.96	100	13.35	13.15
1	609.31	594.43	51	69.64	68.34	101	12.95	12.76
2	579.96	565.78	52	67.06	65.82	102	12.57	12.38
3	552.00	538.63	53	64.60	63.41	103	12.20	12.01
4	525.63	512.97	54	62.24	61.09	104	11.84	11.66
5	500.66	488.67	55	59.97	58.87	105	11.49	11.32
6	477.01	465.65	56	57.80	56.75	106	11.15	10.99
7	454.60	443.84	57	55.72	54.70	107	10.83	10.67
8	433.37	423.17	58	53.72	52.84	108	10.52	10.36
9	413.24	403.57	59	51.98	50.96	109	10.21	10.06
10	394.16	384.98	60	49.96	49.06	110	9.92	9.78
11	376.05	367.35	61	48.19	47.33	111	9.64	9.50
12	358.88	350.62	62	46.49	45.67	112	9.36	9.23
13	342.58	334.74	63	44.86	44.07	113	9.10	8.97
14	327.10	319.66	64	43.30	42.54	114	8.84	8.71
15	312.41	305.33	65	41.79	41.06	115	8.59	8.47
16	298.45	291.73	66	40.35	39.65	116	8.35	8.23
17	285.18	278.80	67	38.96	38.29	117	8.12	8.01
18	272.58	266.51	68	37.63	36.98	118	7.89	7.78
19	260.60	254.72	69	36.34	35.72	119	7.68	7.57
20	249.00	243.61	70	35.11	34.51	120	7.47	7.36
21	238.36	233.14	71	33.92	33.35	121	7.26	7.16
22	228.05	223.08	72	32.78	32.23	122	7.06	6.97
23	218.24	213.51	73	31.69	31.15	123	6.87	6.78
24	208.90	204.39	74	30.63	30.12	124	6.69	6.59
25	200.00	195.71	75	29.61	29.12	125	6.51	6.42
26	191.53	187.44	76	28.64	28.16	126	6.33	6.25
27	183.46	179.57	77	27.69	27.24	127	6.16	6.08
28	175.77	172.06	78	26.79	26.35	128	6.00	5.92
29	168.44	164.90	79	25.91	25.49	129	5.84	5.76
30	161.45	158.08	80	25.07	24.66	130	5.69	5.61
31	154.79	151.57	81	24.26	23.87	131	5.54	5.46
32	148.43	145.37	82	23.48	23.10	132	5.39	5.32
33	142.37	139.44	83	22.73	22.36	133	5.25	5.18
34	136.59	133.79	84	22.01	21.65	134	5.12	5.05
35	131.06	128.39	85	21.31	20.97	135	4.98	4.92
36	125.79	123.24	86	20.63	20.31	136	4.86	4.79
37	120.76	118.32	87	19.98	19.67	137	4.73	4.67
38	115.95	113.62	88	19.36	19.05	138	4.61	4.55
39	111.35	109.13	89	18.75	18.46	139	4.49	4.44
40	106.96	104.84	90	18.17	17.89	140	4.38	4.32
41	102.76	100.73	91	17.61	17.34	141	4.27	4.22
42	98.75	96.81	92	17.07	16.80	142	4.16	4.11
43	94.92	93.06	93	16.54	16.29	143	4.06	4.01
44	91.25	89.47	94	16.04	15.79	144	3.96	3.91
45	87.74	86.04	95	15.55	15.31	145	3.86	3.81
46	84.38	82.75	96	15.08	14.85	146	3.76	3.72
47	81.16	79.61	97	14.62	14.40	147	3.67	3.62
48	78.09	76.60	98	14.18	13.97	148	3.58	3.54
49	75.14	73.71	99	13.76	13.55	149	3.49	3.45
50	72.32	70.96	100	13.35	13.15	150	3.41	3.37

### 3. Pressure sensor voltage output / Detected Pressure Characteristics

Low pressure  $P_L = (V_L - 0.5) \times \frac{10}{3}$

High pressure  $P_H = (V_H - 0.5) \times 10$

Detected pressure (kg/cm<sup>2</sup>)

PL, PH: Detected pressure (kg/cm<sup>2</sup>)

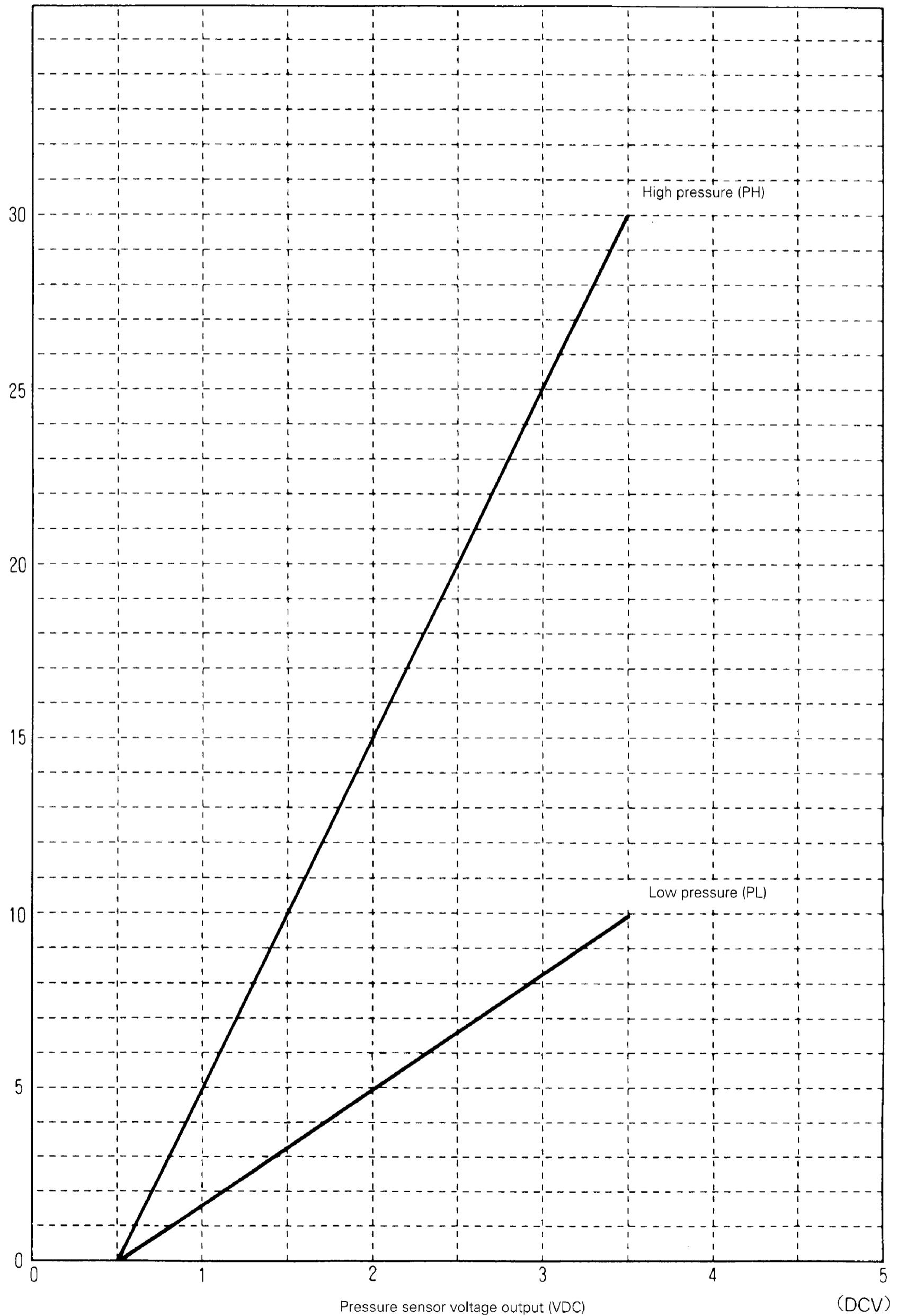

## 4. Method of Replacing the Inverter's Power Transistors and Diode Modules

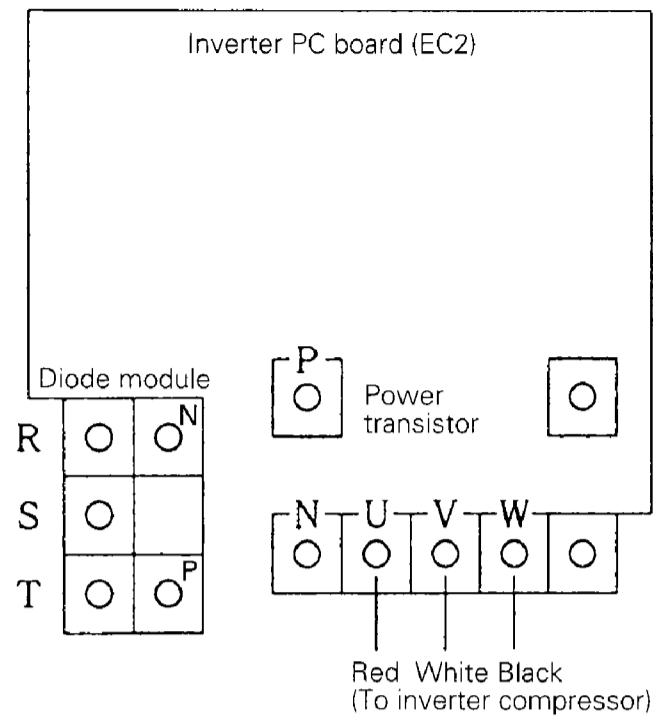

### [Decision according to continuity check by analog tester]

- Before checking, disconnect the electric wiring connected to the power transistor and diode module.

#### 1. Power transistor (on inverter PC board)

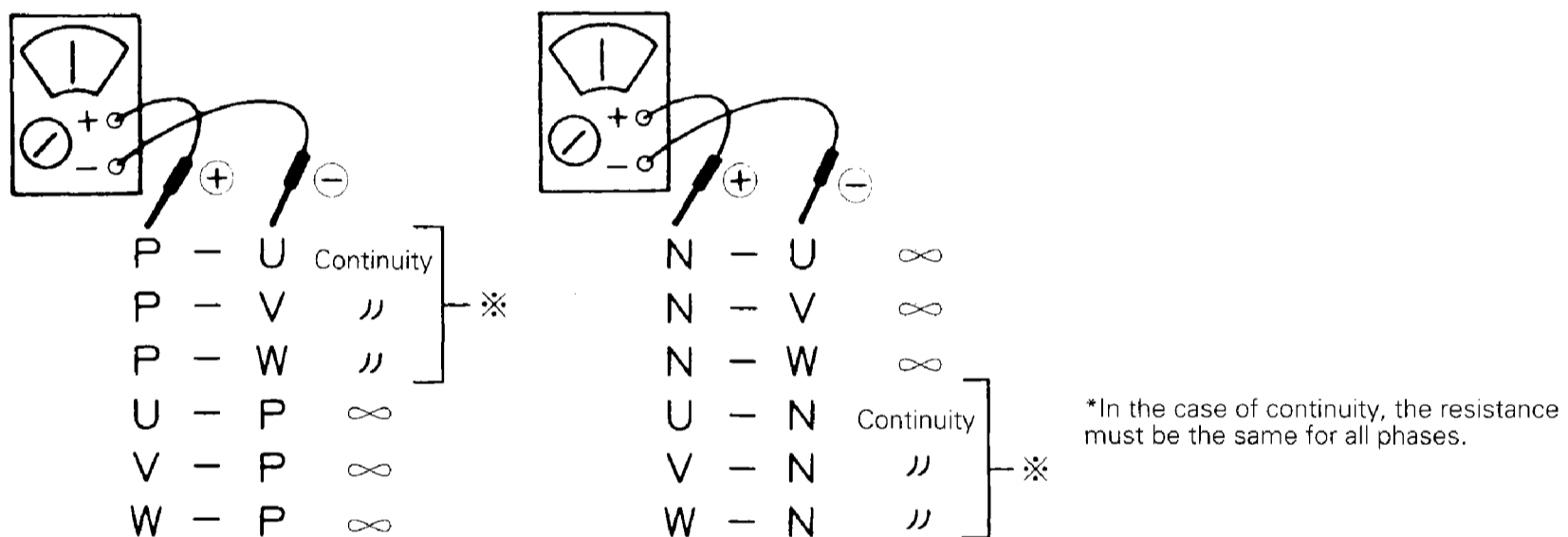

(Decision) If other than given above, the power unit is defective and must be replaced.

Note: If using a digital tester, ∞ and continuity may be reversed.

#### 2. Diode module

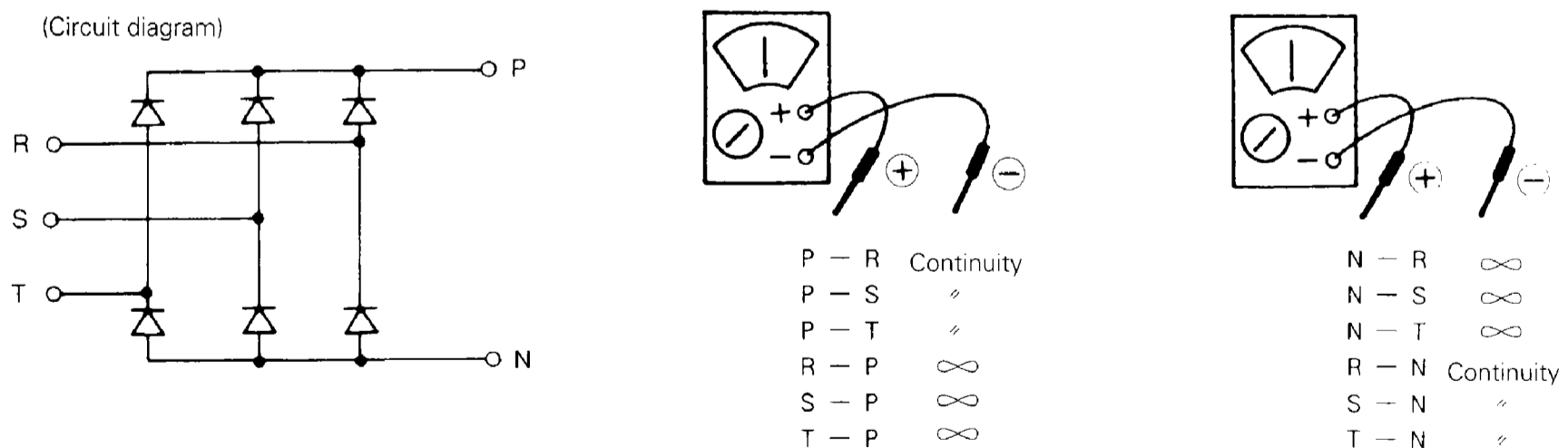

(Decision) If other than given above, the diode module is defective and must be replaced.

Note: If using a digital tester, ∞ and continuity may be reversed.

## 5. Wiring Adaptor for Electrical Appendices (KRP2A61-62)

Various remote control (remote control mode, remote temperature setting, display of operation, display of malfunction) can be carried out by mounting this optional accessory in the indoor unit. Up to 64 groups of indoor units can be monitored and controlled all at once by one adaptor PC board. The wiring adaptor for electrical appendices cannot however be used in combination with other optional controllers for centralized control (central remote controller, unified on/off controller, schedule timer, DDS, etc.).

### Outline of system

#### (1) Individual control (controls indoor units individually)

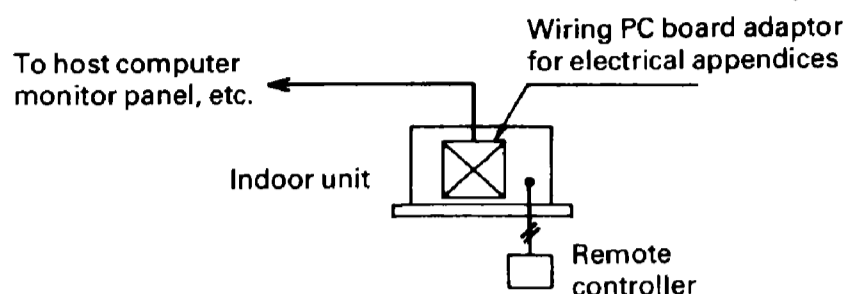

#### (2) Group control (Simultaneously controls group-controlled indoor units [max. 16 units] all together)

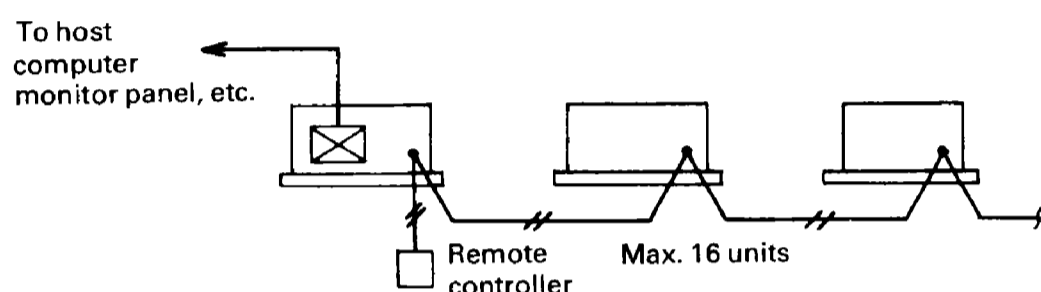

- In the case of individual display, install a wiring PC board adaptor for electrical appendices in the indoor unit.

#### (3) Zone control

(Simultaneously controls up to 64 groups consisting of up to 16 group-controlled indoor units each all together)  
(max. 64 groups × 16 units = 1,024 units).

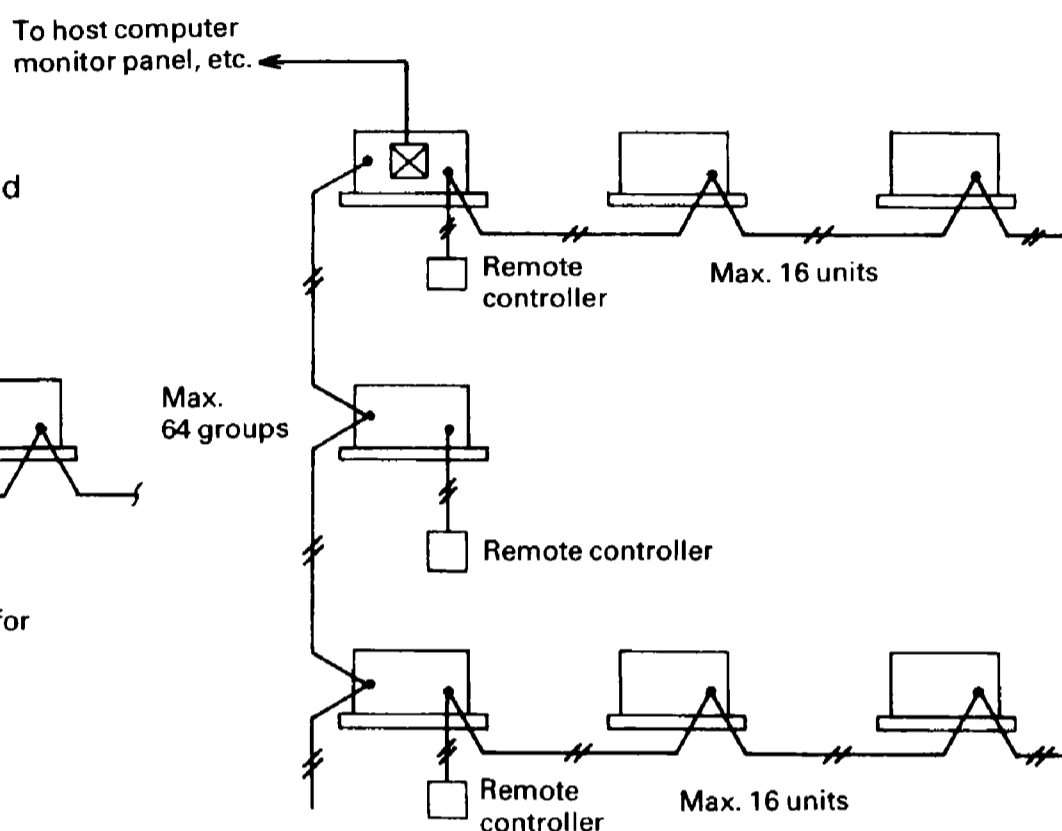

### Wiring

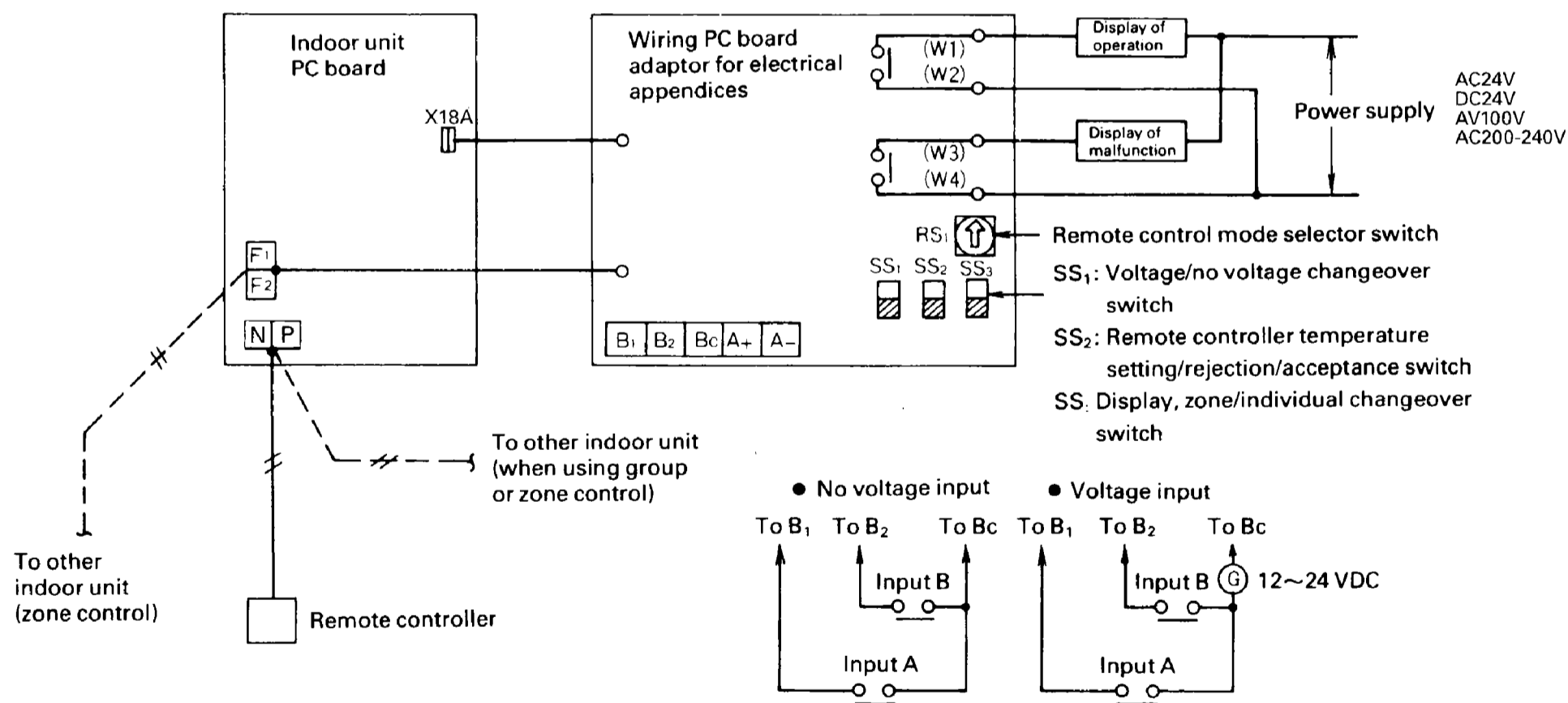

#### Operation signal

- Combined use of constant contact (a) and instantaneous contact (a)
- Combined use of voltage 12~24 VDC, no voltage

#### Control mode

- Remote control mode selector switch (Control contents differ according to input mode. See the following page for details.)

#### Display signal fetch

- Display of malfunction signal (no voltage contact {a})
- Display of operation (no voltage contact {a})
- Remote temperature setting (Can be set from 16~32°C.)

NOTE: ● For voltage input, approximately 10 mA of input current per contact is required.

- In the case of input, use a micro-current contact as the input contact.
- There is no polarity for voltage input. Either plus common or minus common can be used for terminal BC.
- Temperature input is resistance value input of 0~135Ω.

## Wiring to outside (host computer monitor panel, etc.)

### (1) Input for remote control (control mode)

Wire according to the following procedure depending on whether input is "voltage input" or "no voltage input."

#### • Voltage input

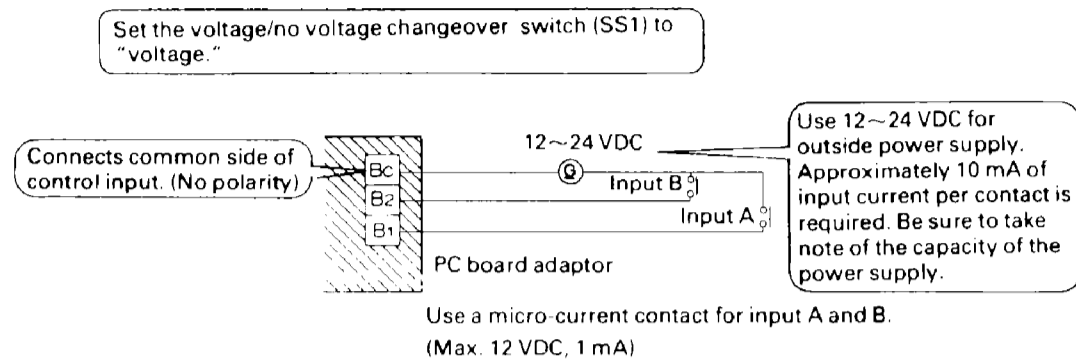

#### • No voltage input

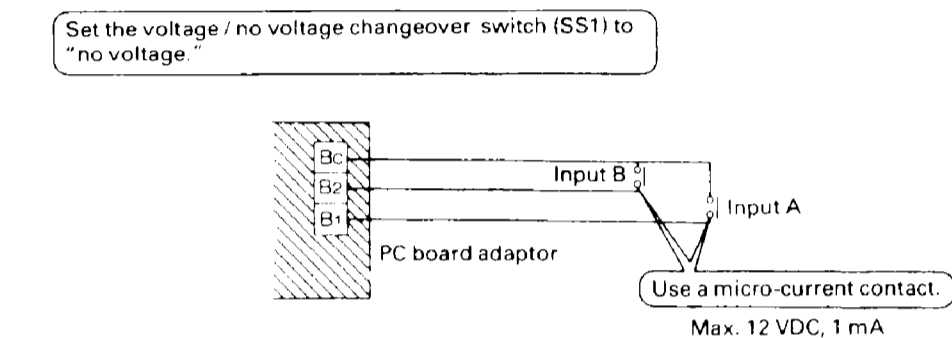

Wiring specifications: Min. 0.18 mm<sup>2</sup> sheathed vinyl cord, length within 150 m

#### • Setting of remote control mode selector switch (RS1)

Control mode with input A and B can be selected and set using the remote control mode selector switch (RS1) on the PC board adaptor.

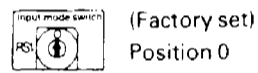

- A) Set to position 0 (direction of arrow) if input is to be disregarded for connection check, etc., or if using as dedicated display function for individual display (connected to any unit other than unit No. 0).  
 B) If controlling operation using constant input for input A:

Position	Function	Contents of input A when ON	Contents of input A when OFF
1	Remote controller inhibit	ON (remote controller normally inhibited)	OFF + remote controller inhibited
2	Centralized priority	ON + remote controller inhibited	
3	OFF by remote controller enabled	ON + OFF by remote controller only enabled (ON by remote controller inhibited)	
4	Remote controller enabled / OFF	Remote controller only enabled (ON by remote controller inhibited)	

\* Input B is for forced OFF. When ON, contents become OFF + ON/OFF control impossible by remote controller, and input A is disregarded. When OFF, even when input A is ON, the contents when input A are not achieved; input A must be input over again.

- C) If controlling operation using instantaneous input for input A:  
 (Use instantaneous input of min. 200 msec ON time.)

Position	Function	Contents of input A
5	Remote controller inhibit	(When ON) Operation stops when input A is ON (When OFF) Runs when input A is ON
6	Individual	(When ON) Operation stops when input A is ON (When OFF) Runs when input A is ON (Remote controller normally enabled)

\* Input B has a forced OFF function (when input B is ON, operation stops and input A is disregarded). When input B is OFF, function of input A is restored.)

#### \* If demand controlling using input B:

Position	Function of input A	Function of input B
C	Remote controller inhibit	Forced thermostat OFF command
D	(Same as position 5)	Forced temperature shift
E	Individual (Same as position 6)	Forced thermostat OFF command
F	(Same as position 6)	Forced temperature shift

\* Forced thermostat OFF command Forces indoor unit to run the fan only.

\* Forced temperature shift Raises preset temperature 2°C when cooling, and lowers 2°C when heating.

NOTE: For zone control, because the units run when RY1 is ON and go off when RY1 is OFF, when in the last command priority mode, some units remain off during operation. At this time even if input A is ON, operation goes off and all units stop running.

- D) If operating by two inputs using instantaneous input for input A and B (Use instantaneous input of min. 200 msec ON time.):

Position	Function	Contents of input A when ON	Contents of input B when ON
7	Remote controller inhibit	ON (remote controller normally inhibited)	OFF + remote controller inhibited
8	Centralized priority	ON + remote controller enabled	
9	OFF by remote controller enabled	ON + OFF by remote controller only enabled (ON by remote controller inhibited)	
A	Remote controller enabled / OFF	Remote controller only enabled (ON by remote controller inhibited)	OFF (remote controller normally enabled)
B	Individual	ON (remote controller normally enabled)	

NOTE: With positions 7~A, if constant input is used there is a forced OFF function (input A disregarded). With position B, constant input cannot be used for input B.

#### (2) Display signal fetch

Normal operation output terminals (W1, W2) and malfunction output terminals (W3, W4) are no voltage, constant contact output. (Allowable current is 10 mA~3 A per contact.)

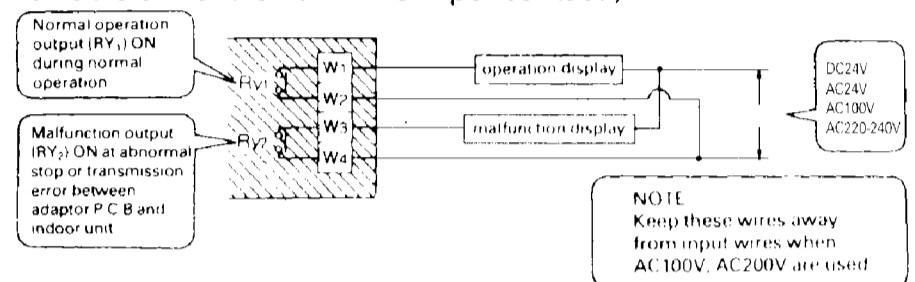

Output for each system is as given in the table below.

Output System	Both RY1 and RY2 OFF	Only RY1 ON	Only RY2 ON
Individual control or individual display	OFF	Normal operation	Stop due to malfunction or transmission malfunction between adaptor PC board and indoor unit
Group control	OFF	All normal operation	Even one unit stopped due to malfunction or transmission malfunction between adaptor PC board and indoor unit
Zone control	All OFF	Even one unit operating normally without malfunction	Even one unit stopped due to malfunction or transmission malfunction between adaptor PC board and indoor unit

#### (3) Temperature setting input

For wiring specifications, we recommend a min. 1.25 mm<sup>2</sup> sheathed vinyl cord, length within 70 m.

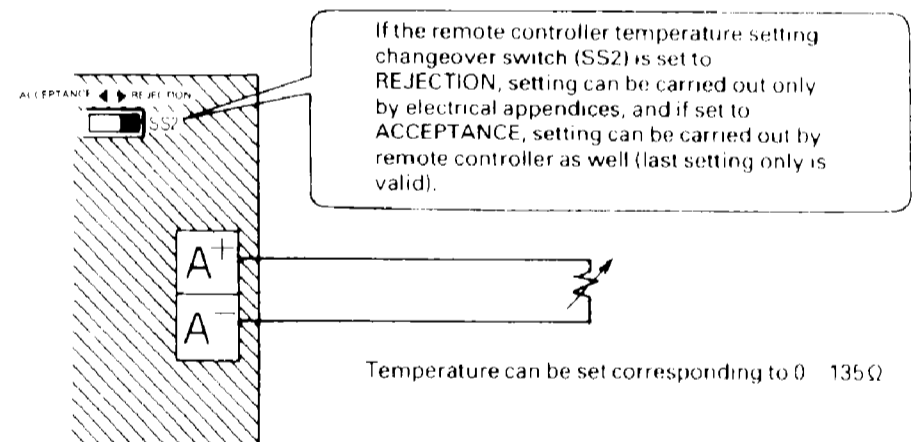

The relationship of preset temperature and resistance is as given in the table below.

Preset temperature (°C)	16	17	18	19	20	21	22	23	24	25	26	27	28	29	30	31	32
Resistance (Ω)	0.0	5.0	13.8	22.4	31.0	39.4	48.2	56.6	65.2	73.8	82.4	91.0	99.4	108.6	117.2	125.8	134.2
	3.4	11.6	20.0	28.4	36.4	44.8	52.8	61.2	69.4	77.8	85.8	94.0	102.2	110.4	119.2	127.4	140.0

NOTE: Resistance given in the table includes resistance of the wiring.

## Wiring adaptor PC board for electrical appendices optional accessories and mounting position

(See adaptor for wiring for details on mounting position.)

Model name	FXYC-K	FXYK-K FXYS-K FXYA-K FXYL-K FXYM-K	FXYF-K	FXYH-K
Adaptor PC board optional accessories name	KRP2A61	KRP2A61	KRP2A62	KRP2A62
Adaptor PC board mounting box optional accessories name	KRP1896	—	KRP1A90	KRP1B93
Adaptor PC board and mounting box storage position				

NOTE: The mounting position of mounting boxes FXYF ~ H is inside the unit if using one adaptor PC board. If equipped with an air cleaner unit, however, the mounting box is mounted on the side of the main body. If using two types of adaptor PC boards, two mounting boxes must be mounted on the side of the main body.



## 6. Wiring Adaptor for Group Electrical Appendices (KRP4A51 / KRP4A52 / KRP4A53)

The wiring adaptor for group electrical appendices cannot be used in combination with a central remote controller, unified ON/OFF controller, schedule timer, data station, etc.

### <Objective / use>

The wiring adaptor for group electrical appendices is used for turning units on/off and setting temperature from a remote location, display of operation, and invoking display of malfunction. A single adaptor enables unified control of groups connected to the remote controller transmission line (N/P).

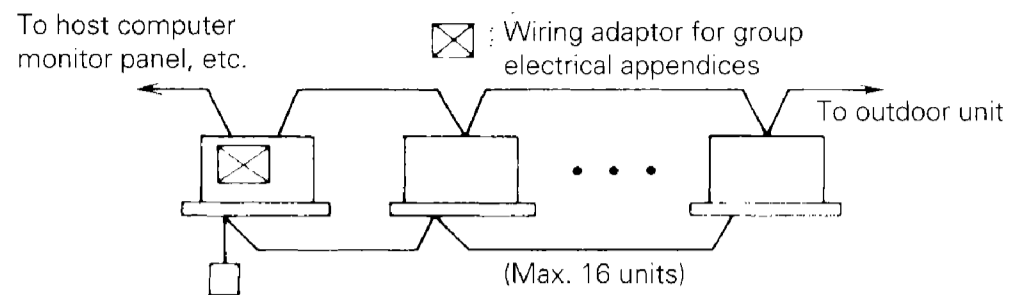

### Part names and functions

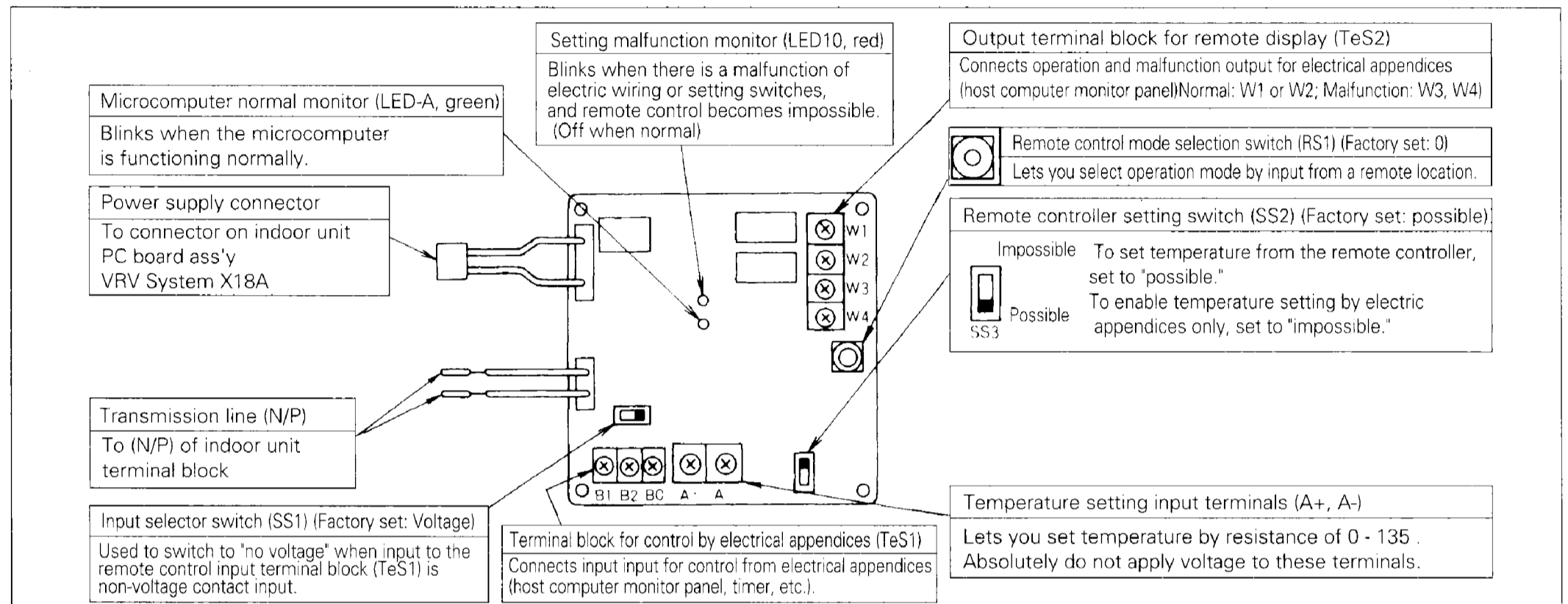

### Wiring to outside (host computer monitor panel, etc.)

#### (1) Input for control by electric appendices (on/off control)

Wire as described below depending on whether input is "voltage input" or "non-voltage input."

##### • Voltage input

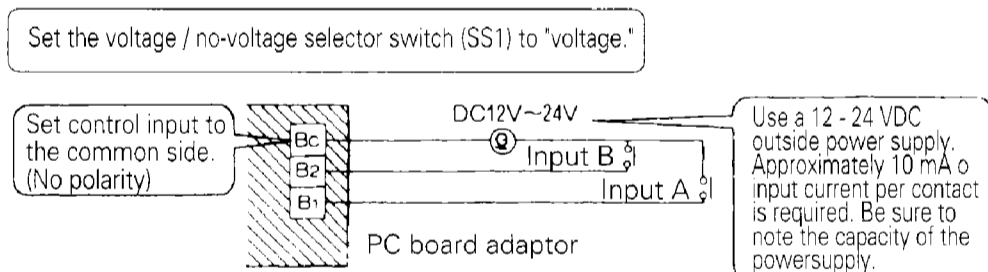

Use a micro-current contact for input A and B. (Max. 12 VDC, 1mA)

##### • No-voltage input

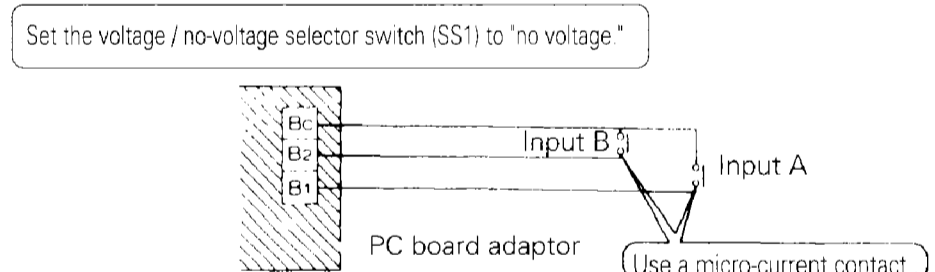

Wiring should be sheathed vinyl cord of min. 0.18 mm<sup>2</sup>, total length no more than 150 m.

#### • Remote control mode selector switch (RS1) setting

Position	Function	Operation by input mode A and B	
		Input A (between B1 ~ Bc)	Input B (between B2 ~ Bc)
0	Disregard input	—	—
1	Remote controller inhibited	Operates by ON and stops by OFF	Stops by ON, remote controller inhibited Disregard input A Input A permitted by OFF
2	Central priority	Operates by ON (remote controller permitted) and stops by OFF (remote controller inhibited)	
3	Remote controller permitted / inhibited	Same as mode 1 (OFF by remote controller always permitted)	
4	Remote controller permitted / inhibited / OFF	ON by remote controller permitted, stops by OFF (remote controller inhibited)	
5	Remote controller inhibited	ON / OFF (cyclic)	Stops by ON, remote controller inhibited Remote controller permitted by OFF
6	Individual	Same as mode 5 (only OFF by remote controller always permitted)	
7	Remote controller inhibited	Operates by ON	Stops by ON
8	Central priority	Operates by ON (remote controller permitted)	Inhibited by ON (remote controller inhibited)
9	OFF by remote controller permitted	Same as mode 7 (OFF by remote controller always permitted)	Same as mode 7
A	Remote controller permitted / inhibited / OFF	ON by remote controller permitted	Remote controller inhibited by ON
B	Individual	Same as mode 7 (remote controller always permitted)	Same as mode 7
C	Mode 5 + energy efficiency control	Same as mode 5	Forced OFF by thermostat by ON
D	Mode 5 + room temperature setting shift		Room temperature shift operation by ON
E	Mode 6 + energy efficiency control	Same as mode 6	Forced OFF by thermostat by ON
F	Mode 6 + room temperature setting shift		Room temperature shift operation by ON

Note: Forced off (disregard input A) is effected when using input B constant input at positions 7~A. Input B constant input cannot be used by B.

<Example of when the remote control selector switch (RS1) is set to No. 6>

Below are remote control commands relative to input signal and indoor unit time chart

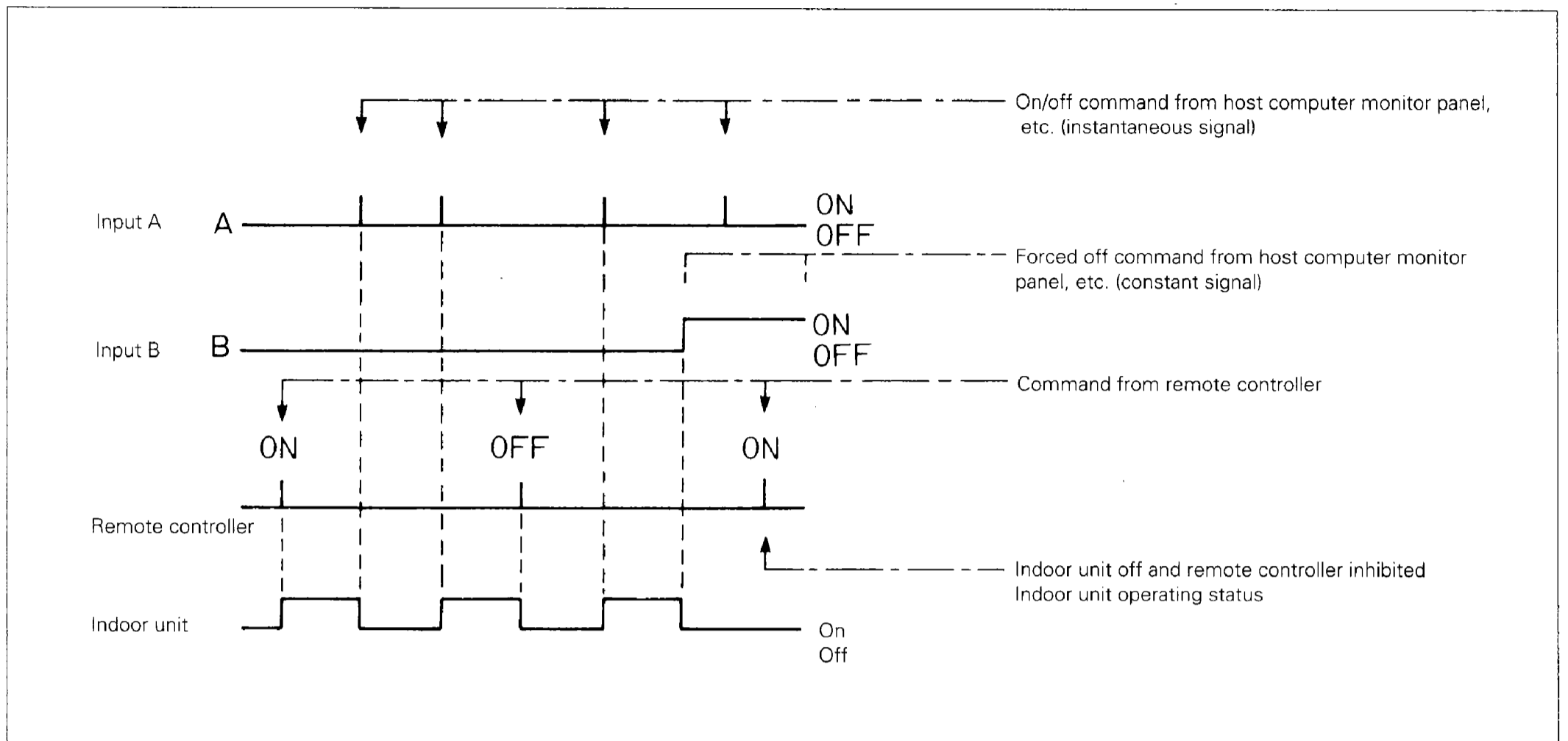

## (2) Display signal fetch

Normal operation output terminals (W1, W2) and malfunction output terminals (W3, W4) are no voltage, constant contact output.

(Allowable current is 10 mA~3 A per contact.)

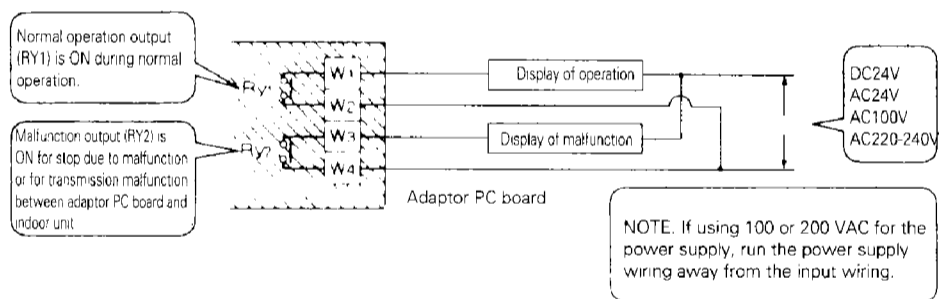

Output for each system is as given in the table below.

System	Output	Both RY1 and RY2 OFF	Only RY1 ON	Only RY2 ON
Individual control or individual display		OFF	All normal operation	Even one unit stopped due to malfunction or transmission malfunction between adaptor PC board and indoor unit
Group control				

## ■ Applicable models and whether mounting box is required or not

Model name	Adaptor	Mounting box / plate	Mounting position
FXYC-K FXYK-K FXYS-K FXYM-K FXYL(M)-K FXYA-K	KRP4A51	Not required	Mounted inside electrical parts box of main unit
FXYH-K	KRP4A52	KRP1B93	Mounted outside main unit
FXYF-K	KRP4A53	KRP1A90	Mounted outside main unit

## (3) Temperature setting input

For wiring specifications, we recommend a min. 1.25 mm<sup>2</sup> sheathed vinyl cord, length within 70 m.

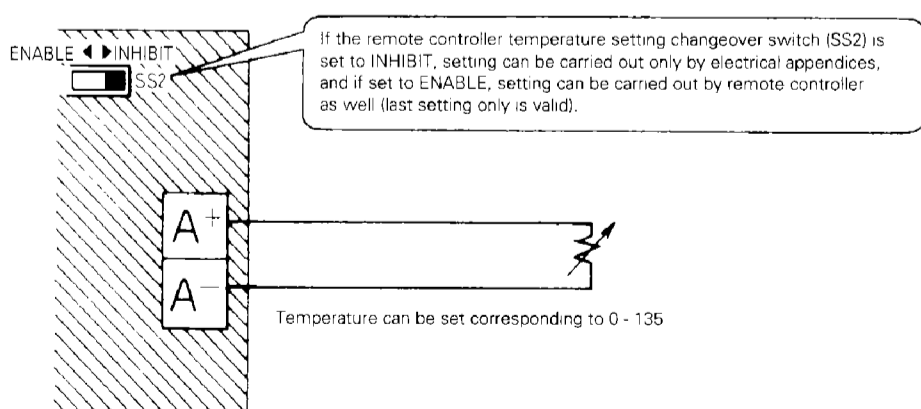

The relationship of preset temperature and resistance is as given in the table below.

Preset temperature (°C)	16	17	18	19	20	21	22	23	24	25	26	27	28	29	30	31	32
Resistance (Ω)	0.0	5.0	13.8	22.4	31.0	39.4	48.2	56.6	65.2	73.8	82.4	91.0	99.4	108.6	117.2	125.8	134.2
	3.4	11.6	20.0	28.4	36.4	44.8	52.8	61.2	69.4	77.8	85.8	94.0	102.2	110.4	119.2	127.4	140.0

## 7. Adaptor for Wiring (KRP1B61 / KRP1B2 / KRP1B3)

<Objective / use>

Enables you to fetch compressor and fan operation output when optional accessories (auxiliary electric heater, humidifier, fresh air intake kit [with fan duct]) are installed.

### Part names and functions

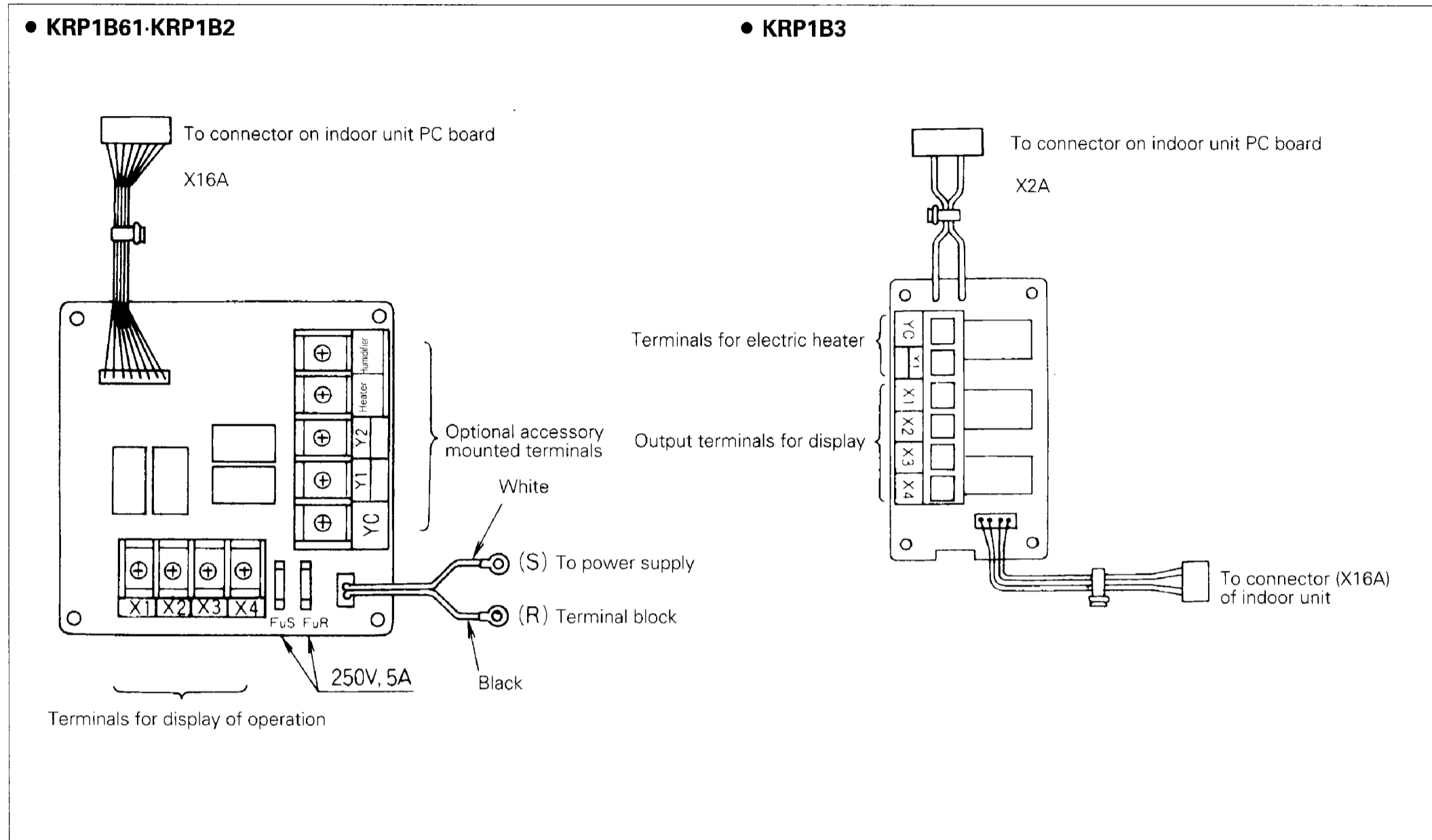

### (1) Applicable models and whether optional accessories are required or not

Model name	Adaptor	Mounting box / plate	Electric heater	Natural evaporation humidifier	Ultrasonic humidifier	Other required optional accessories	Mounting position
FXYC-K	KRP1B61	Not required	○	○	—	—	Mounted inside electrical parts box of main unit
FXYK-K			○	○	—	—	
FXYS-K			○	○	○	Hot water heater	
FXYM-K			○	○	○	Hot water heater	
FXYL(M)-K			○	—	—	—	
FXYH-K			○	—	—	—	
FXYF-K	KRP1B2	KRP1A90	○	○	—	Duct fan	Mounted inside main unit
FXYA-K	KRP1B3	Not required	○	—	—	—	Mounted inside electrical parts box of main unit

### (2) Operation display fetch

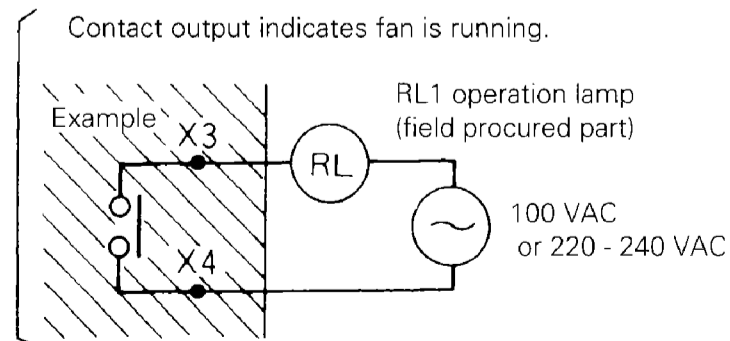
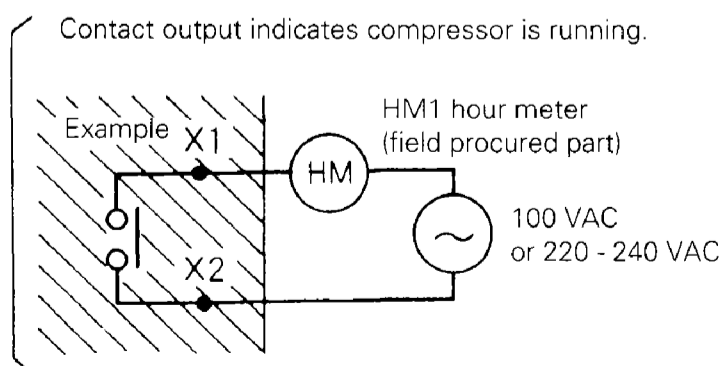

## 8. Interface Adaptor for SKY AIR Series (DTA102A52)

<Objective / use>

The interface adaptor for SKY AIR series lets you connect optional controllers for centralized control (central remote controller, unified ON/OFF controller, schedule timer) with SKY AIR.

### Part names and functions

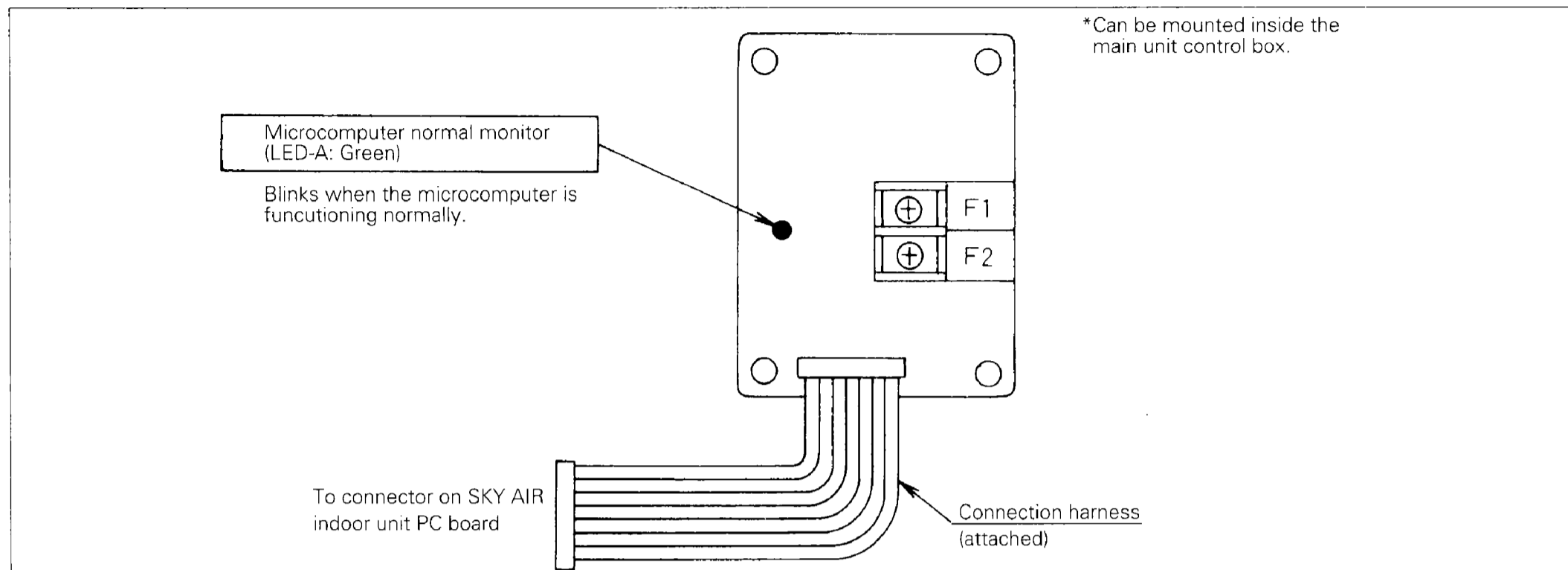

<System outline>

If using VRV System Inverter in common with transmission line, connect either (A) indoor-to-outdoor unit transmission wiring or (B) outdoor-to-outdoor unit transmission wiring.

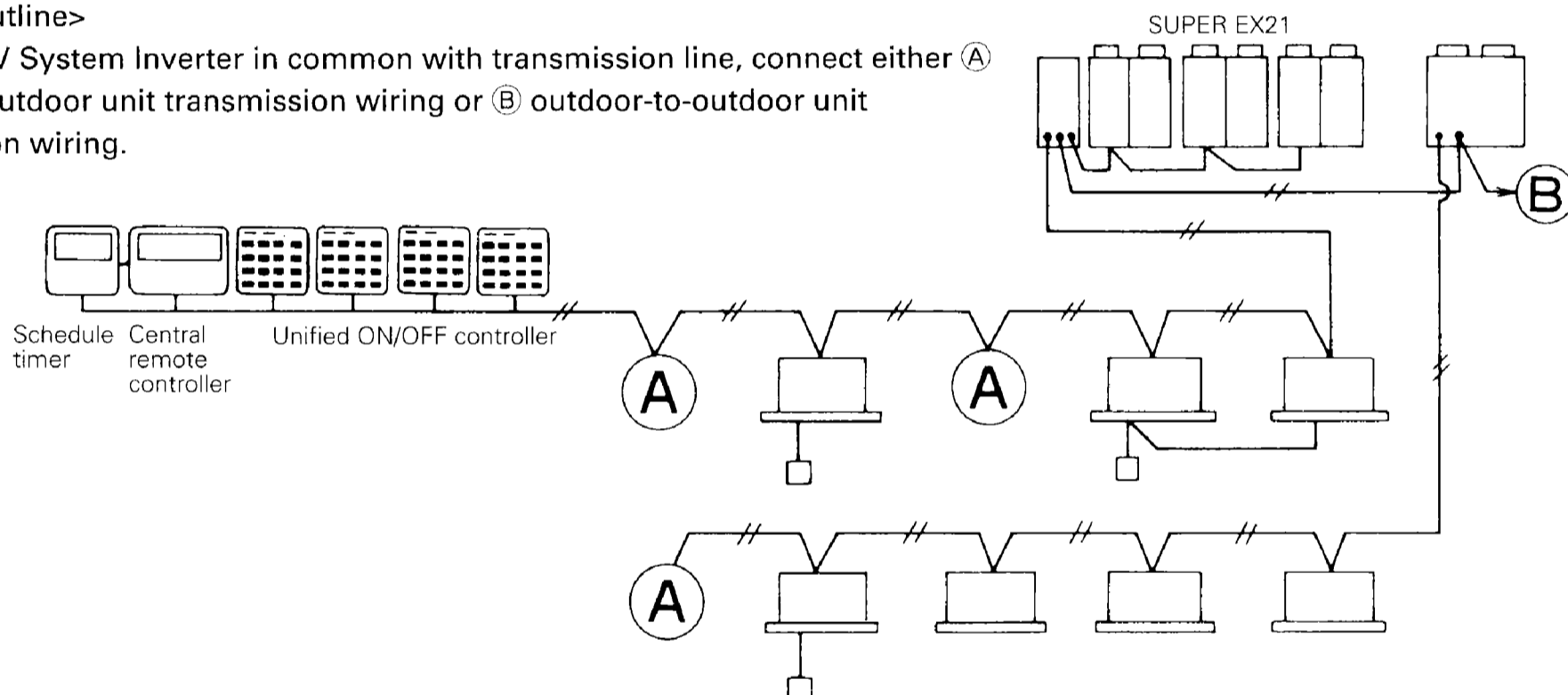

### Connection

Interface adaptor for SKY AIR series

	Independent control	Group control	HRV energy efficient operation
Pair	<p>F1,F2 F1,F2</p> <p>Wired remote controller Wireless remote controller</p>	<p>F1,F2</p> <p>Max. 16 units</p>	<p>F1,F2</p>
Multi	<p>Individual operation Simultaneous operation</p> <p>Required for each indoor unit</p>	<p>Individual operation Simultaneous operation</p> <p>Max. 16 units with simultaneous operation type counted as one unit</p>	<p>Simultaneous operation</p>

## 9. Wiring Adaptor for Other Air Conditioners (DTA103A51)

This optional accessory is a contact input/output interface adaptor for optional controllers for centralized control and apparatus that cannot be directly connected to them. Connecting this optional accessory to an optional controller for centralized control lets you turn the apparatus on/off by optional remote controller for centralized control and monitor normal operation and malfunctions. This optional accessory can be connected with a power consumption counting unit or data station.

### Outline of system

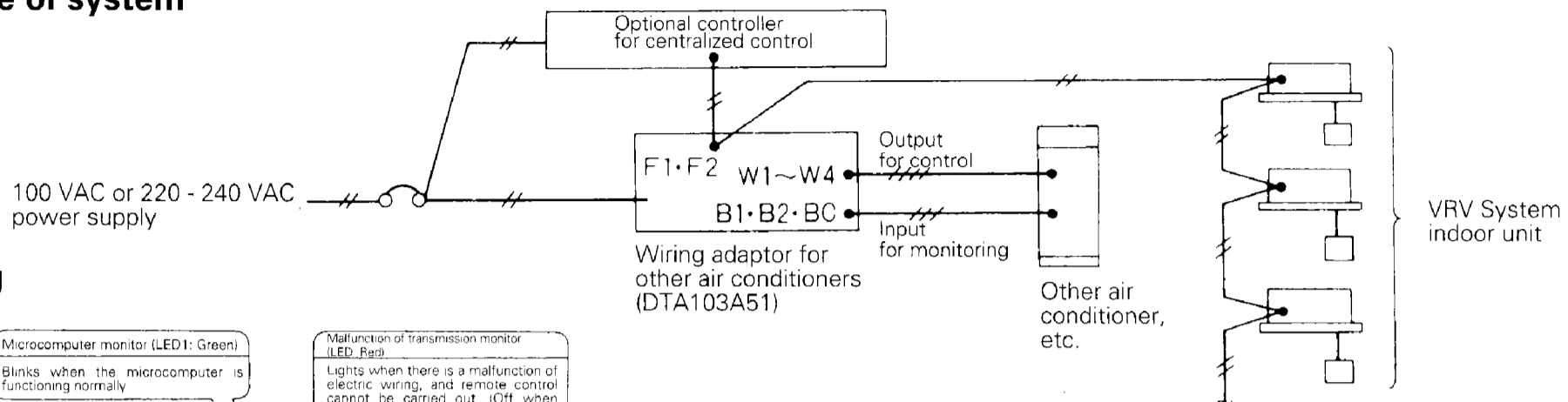

### Wiring

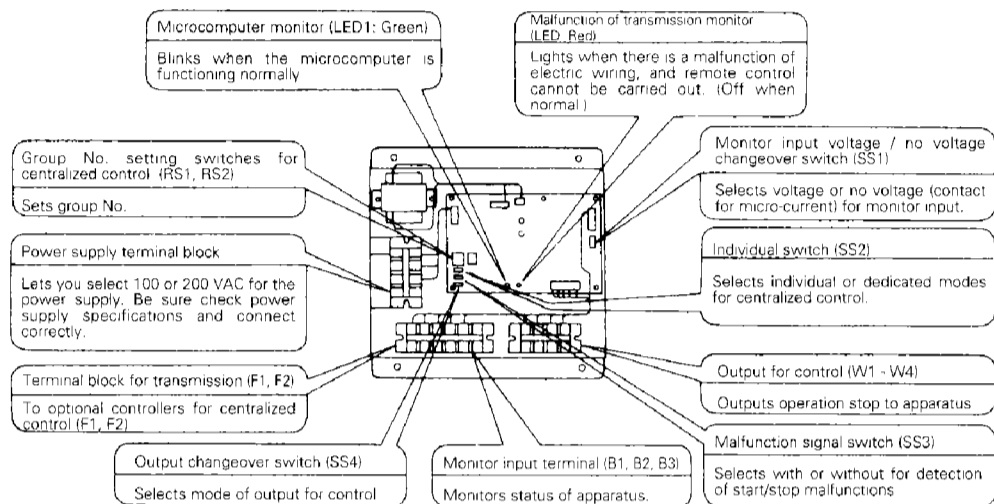

- Setting of group No. for centralized control  
Set from among 1~4 with setting switch RS1.  
Set from among 0~9 and A~F with RS2.  
Be careful not to duplicate a group No. of other apparatus when setting.

#### (2) Output for control

- ON output terminals (W1, W2) and OFF output terminals (W3, W4) are no voltage contact output.
- Contact specifications are 2 A~1 mA for 220~240VAC, and 3 A~1 mA for 5~24 VDC.

Output mode changeover switch SW3		Ry1	Ry2
Constant	Instruction from optional controller for centralized control is ON.	ON	OFF
	Instruction from optional controller for centralized control is OFF.	OFF	ON
Instantaneous	Instruction from optional controller for centralized control is ON.	(ON)	OFF
	Instruction from optional controller for centralized control is OFF.	OFF	(ON)

(ON): Instantaneous output of 1 second ON

- An adaptor for wiring is required for remote control in order to receive output for control of wiring adaptor for other air conditioners such as ordinary air conditioner, etc.

#### (3) Input for monitoring

Wire according to the following procedure depending on whether input is "voltage" or "no voltage."

##### ● For voltage input:

Set the voltage / no voltage changeover switch (SS1) to "voltage."  
(Factory set setting complete)

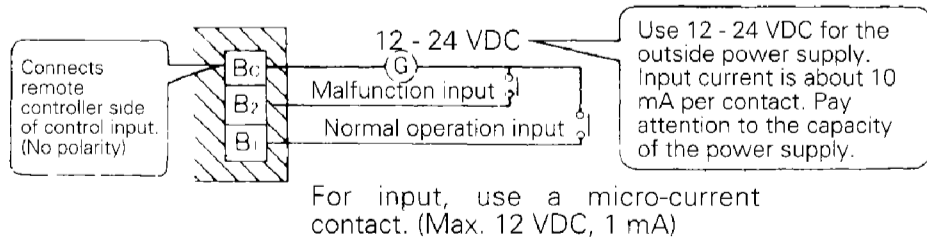

##### ● For no voltage input:

Set the voltage / no voltage changeover switch (SS1) to "no voltage."

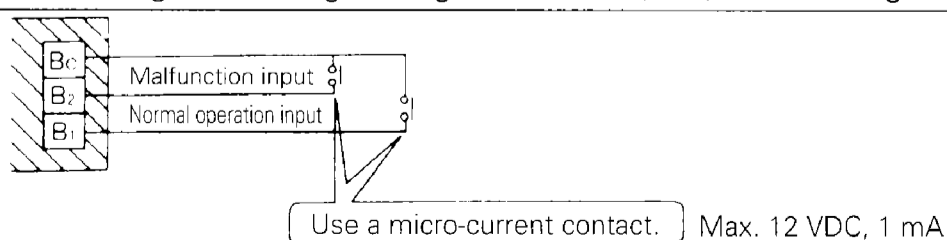

- If you want to connect output which is to be ON when apparatus is operating normally, disconnect the short circuit wire between B1

- Connect output which is to be ON when apparatus is malfunctioning between B2 and BC. (You can fetch stop malfunction in the case of stop malfunction.)
- When operating from optional controllers for centralized control, if between B2 and BC is ON or stop malfunction with / without switch (SS3) is set to "with," in the case of between B1 - BC being ON, optional controllers for centralized control display a malfunction (malfunction code A1).
- After switching from OFF to ON with an optional controller for centralized control, it takes 10 - 30 for the monitor to display a malfunction.

#### (4) Individual changeover switch (SS2)

Switch for toggling between individual mode and dedicated central mode (stop cannot be effected from other air conditioner).

For "without individual," stop can be effected from optional central controller only.

For "with individual," stop can be effected from other air conditioner as well.

(Factory set is "without individual.")

#### (5) Malfunction signal switch (SS3)

Switch for carrying out malfunction detection for stop operation from optional central controller.

In the case of "with stop malfunction," if operation concerning stop does not follow, the optional central controller carries out display of malfunction.

In the case of "without stop malfunction," even if operation concerning stop does not follow, the optional central controller does not carry out display of malfunction.

(If SS2 is set to "with last command priority," this switch becomes inoperable.)

(Factory set is "without stop malfunction.")

#### (6) Output changeover switch (SS4)

Switch for toggling relay output between constant and instantaneous.  
(Factory set is "instantaneous.")

- Display of optional controllers for centralized control that make monitor input status by combination of various switches

Setting / Combination	Individual	Stop malfunction	Central display when there is an ON instruction from optional controller for centralized control		
			With ON input	Without ON input	With malfunction input
1	With	With	ON	OFF	Malfunction
2		Without	ON	OFF	Malfunction
3	Without	With	ON	Malfunction	Malfunction
4		Without	ON	ON	Malfunction

### Mounting of DTA103A51

- Storage box is field supplied.
- Outer dimensions: 230(W) x 230(D) x 60(H)

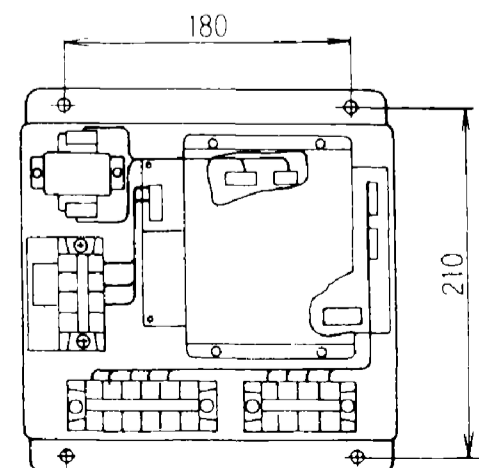

# 10. External Control Adaptor for Outdoor Units (DTA104A61-DTA104A62)

<Objective/use>

By adding an adaptor for outside control of outdoor units to BS units or indoor units connected in a DIII-NET, you can simultaneously select cool/heat mode for several outdoor units in the system, and it enables demand control and low noise control.

■ Part names and functions

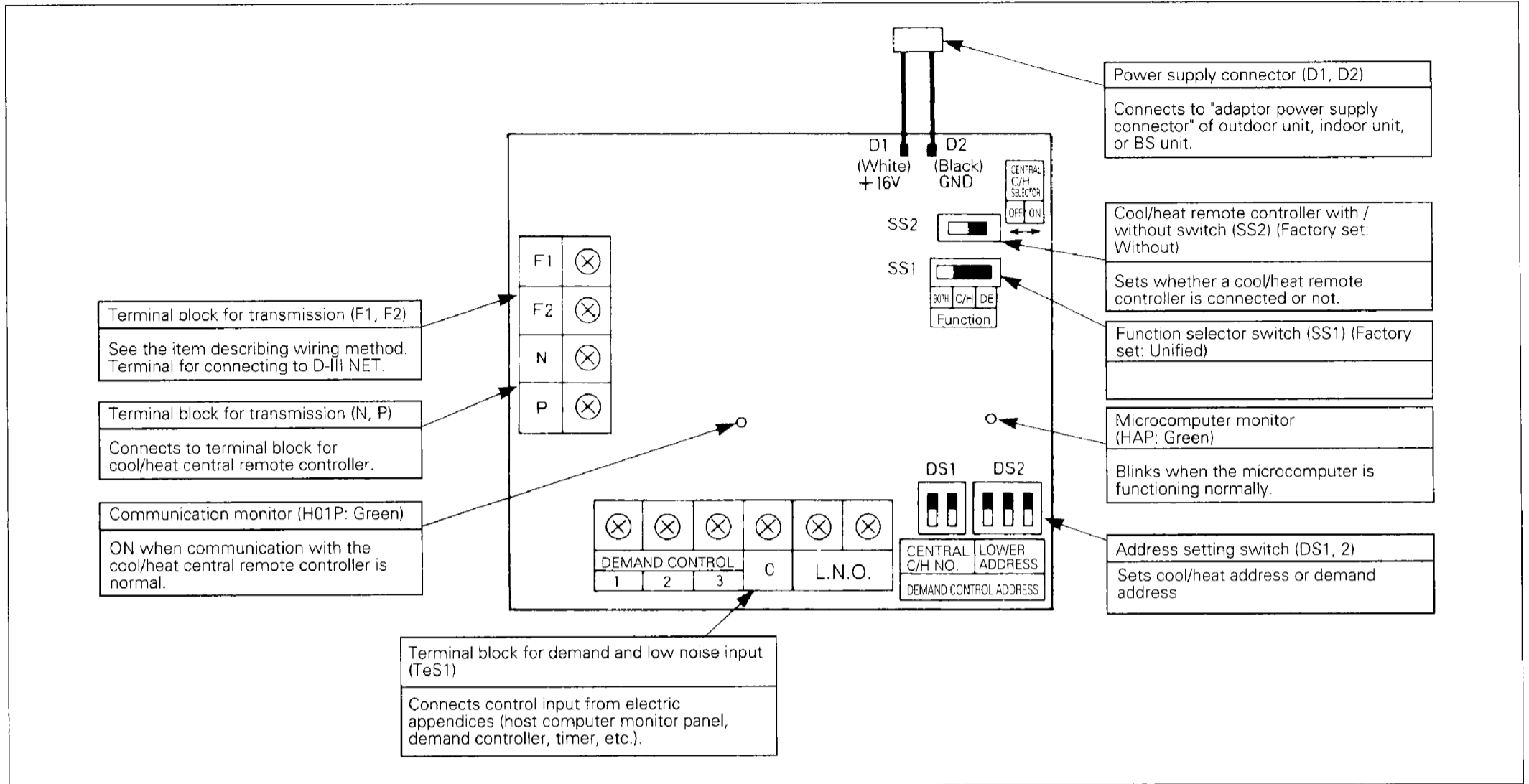

(1) Cool/heat mode unified selection (For detailed example of wiring, see the page describing cool/heat mode control.)

<System outline>

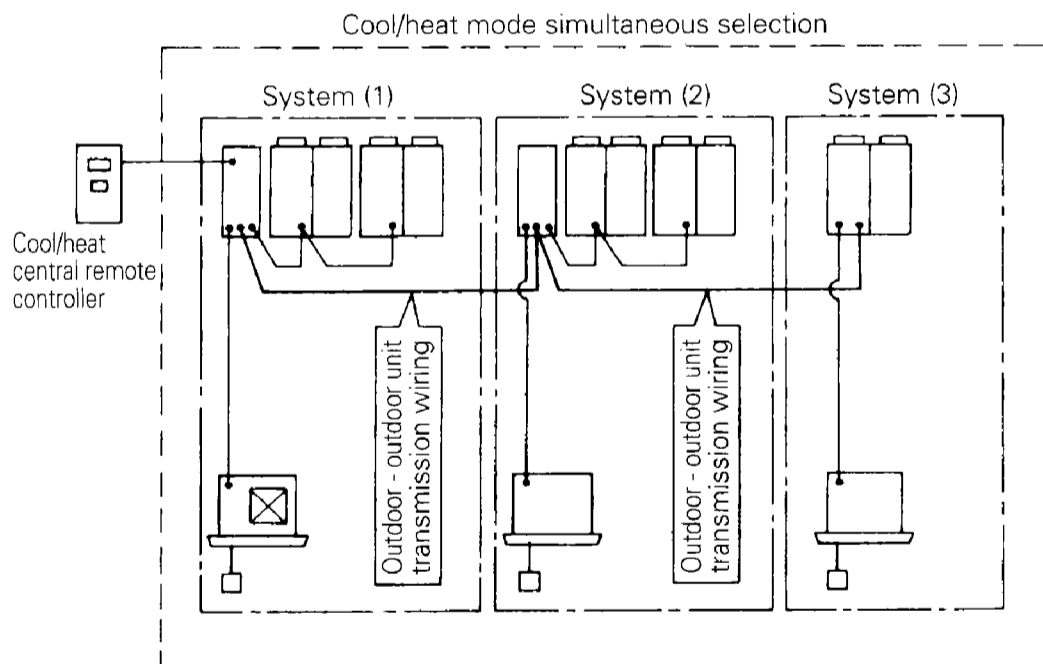

<Settings of switches on the PC board adaptor>

- SS1: 

[ON]		
BOTH	C/H	DE

 C / H ("BOTH" is selected when demand control is carried out at the same time.)
- SS2: 

[ON]	
OFF	ON

 OFF
- DS1-2: Set the same address as the cool/heat mode address of the function unit.

<NOTE> ... For super EX21

- Set the SS1 cool/heat selector switch on the function unit to "outdoor." You must also set cool/heat selector "master" or "slave" by pushbutton switch.

**(2) Demand / low noise control**

Connecting control input to the adaptor for outside control of outdoor units enables demand and low noise control.

**■ Demand control (figures indicate demand rate)**

When short circuit between (1) and (C): Approx. 70% as a guideline

When short circuit between (2) and (C): Approx. 40% as a guideline

When short circuit between (3) and (C): Forced fan operation

<System outline>

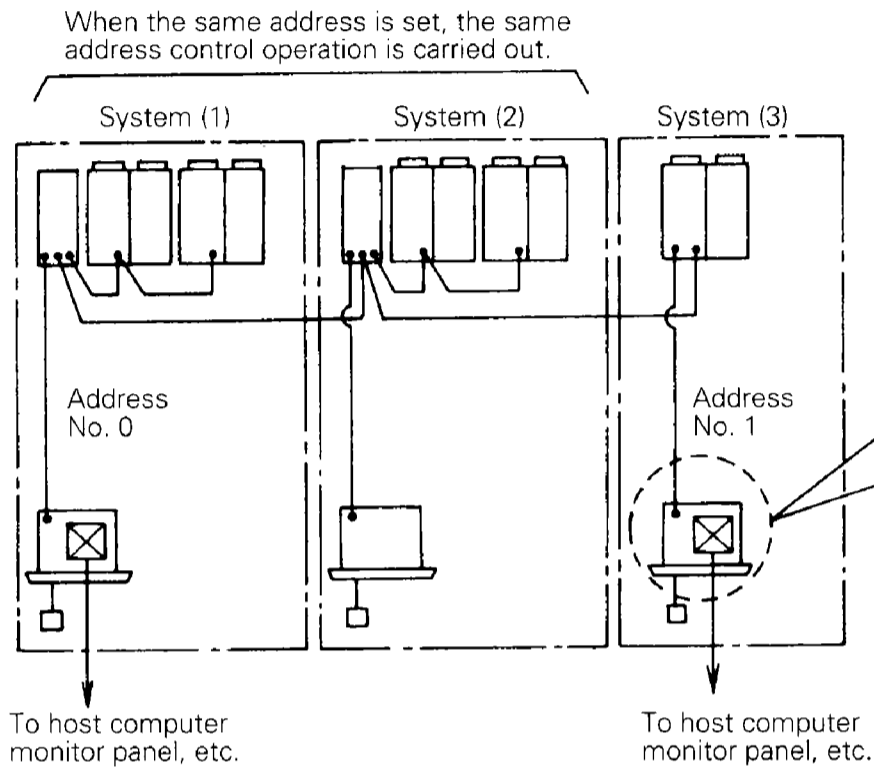

**■ Low noise control (Outdoor unit)**

Running noise can be reduced by 2~ 3dB by controlling capacity of outdoor unit.

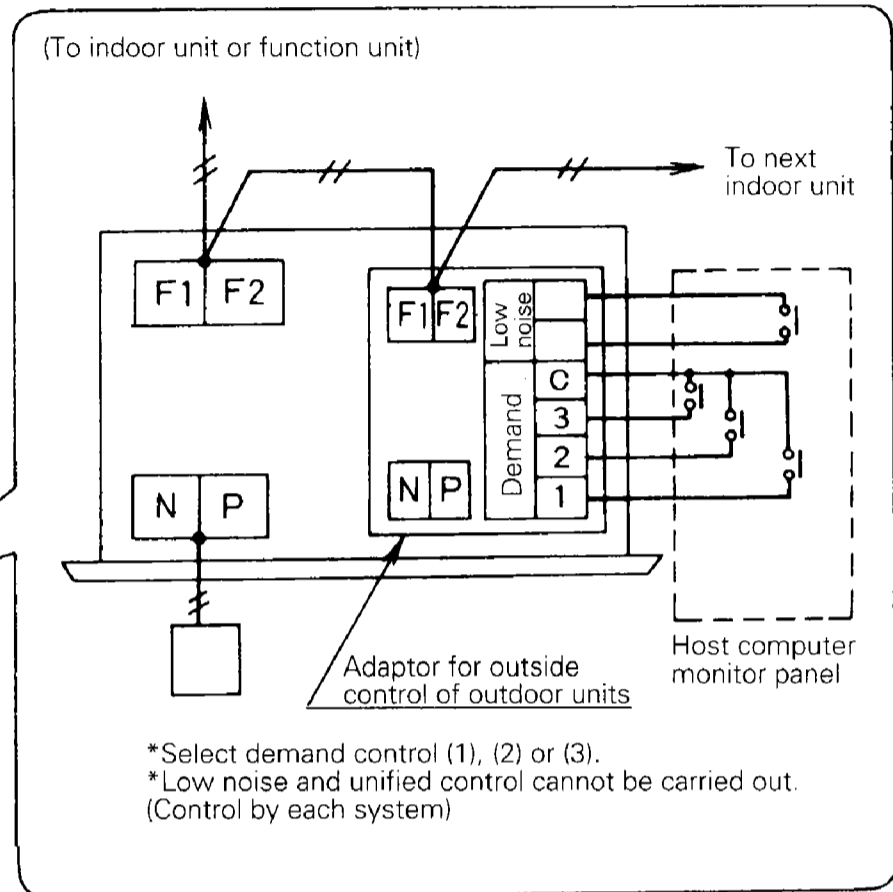

\*Select demand control (1), (2) or (3).  
\*Low noise and unified control cannot be carried out. (Control by each system)

**[Common]**

<Address setting (DS1 / DS2)>

Decide the address for each control unit from 0~9 and set.

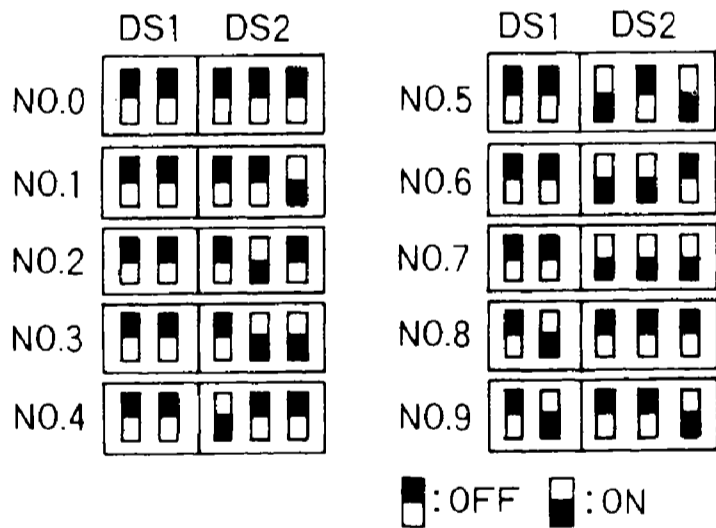

**NOTES**

- Setting is within 8 groups when using a cool/heat central remote controller. Set from No. 0~No. 7.
- Be sure to make the address No. of the PC board adaptor described above match the address No. of function unit or outdoor unit (BS unit if using cool/heat simultaneous selection type). (For detailed settings, see the installation manual.)

<Control input specifications>

**■ Input signal**

Constant contact a

Input current is approx. 12 - 24 VDC, 10 mA per contact.

Use a micro-current contact for the relay contact.

(Max. 12 VDC, 1 mA)

**■ Outside wiring specifications**

Recommended electric wiring: Sheathed vinyl cord or cable 0.75~1.25 mm<sup>2</sup> (double core)

Wiring length: Max. 150 m

Run separate from power line in order to prevent malfunction.

# 11. Unification Adaptor for Computerized Control (DCS302A52)

Connecting a unification adaptor for computerized control to the central remote controller enables unified display on the host computer monitor panel (display of operation and malfunction), and unified control from the host computer monitor panel (on/off commands).

## System outline

(1) Unified display (Displays operation and malfunctions of all indoor units controlled by central remote controller on a host computer monitor panel.)

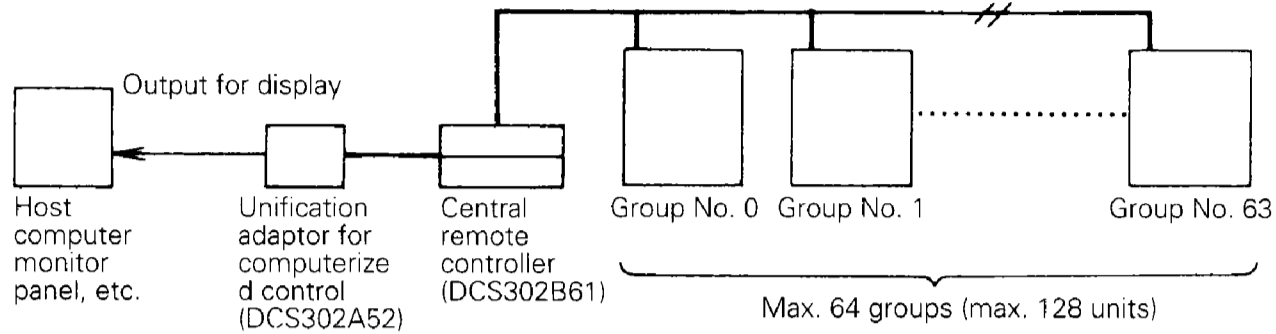

(2) Unified control (Enables unified display of all indoor units controlled by central remote controller and unified ON/OFF control from a host computer monitor panel.)

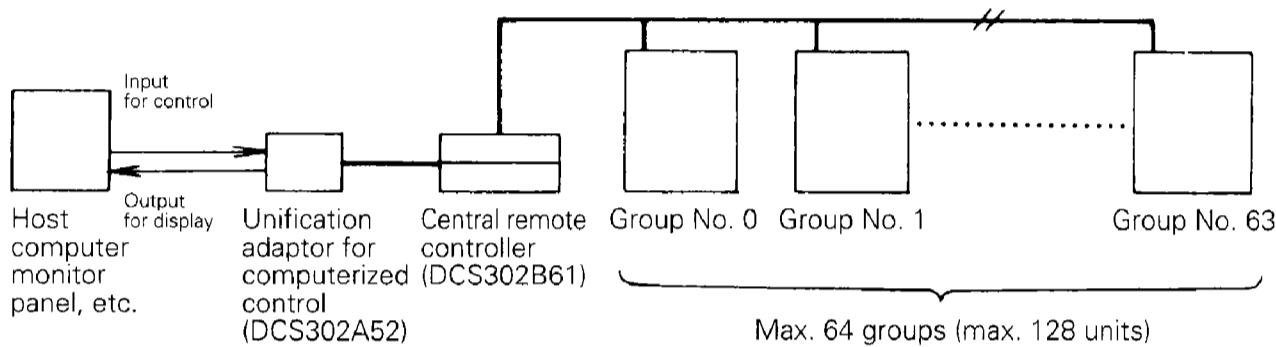

## Wiring

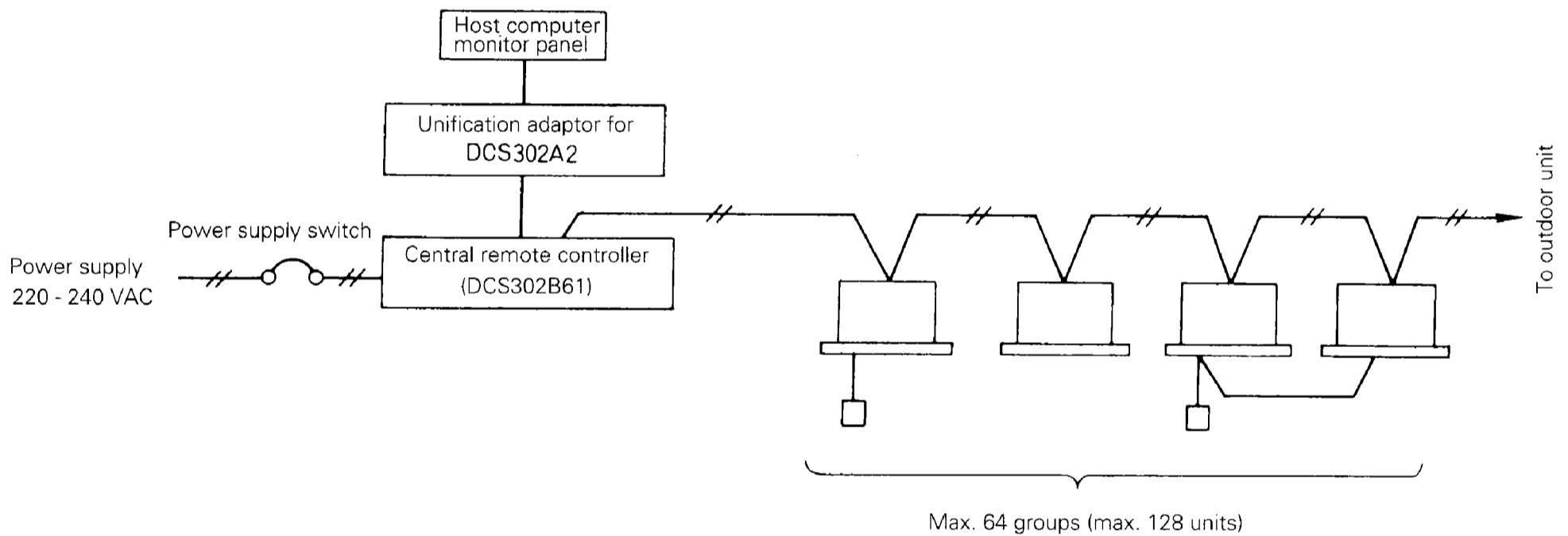

### Wiring to central remote controller

Connect the unification adaptor for computerized control to connector No. CN2 of the central remote controller with the attached wiring for transmission.

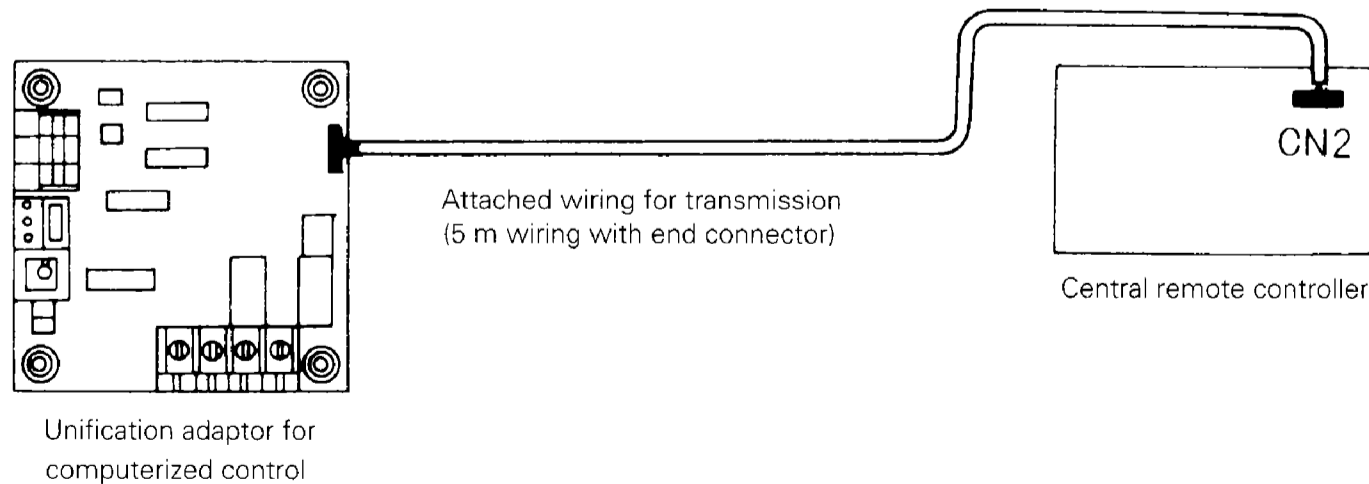



## Wiring

### (1) Part names and functions

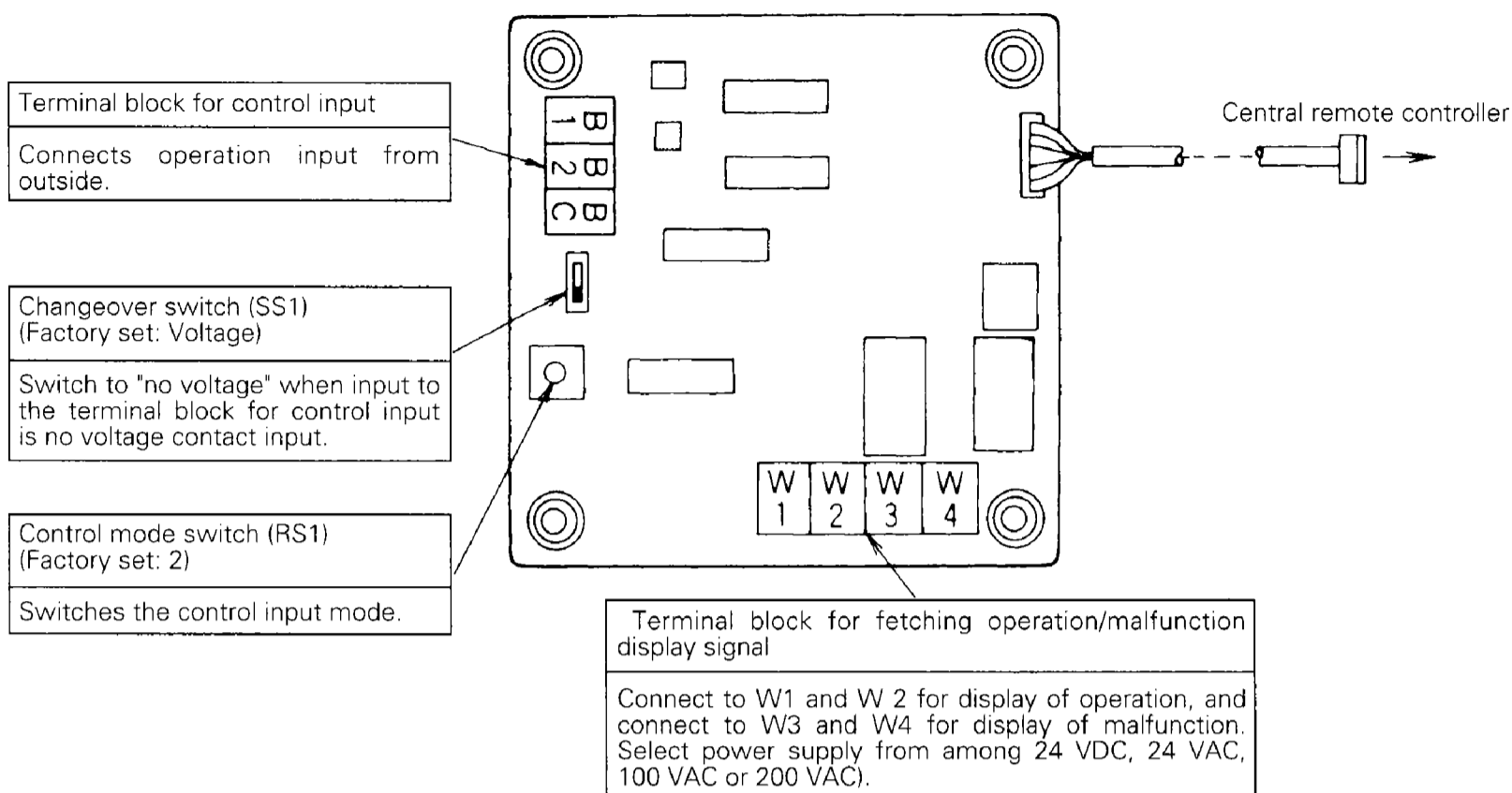

### (2) External control input (wiring to host computer monitor panel, etc.)

#### Specifications of wiring for transmission

- 0.75~1.25 mm<sup>2</sup> sheathed vinyl cord or cable (double core),  
Max. length 150 m

#### Control input (unified ON/OFF control)

Wire as described below according to whether input is "voltage" or "no voltage."

##### • Contact a input for both input A and B (voltage)

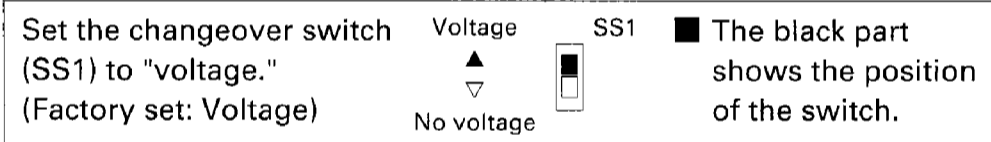

Use 12 - 24 VDC for external voltage. Approx. 10 mA of input current per contact is required. Be sure to note the capacity of the power supply.

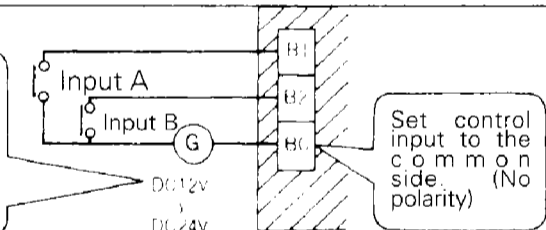

For input, use a micro-current contact. (Max. 12 VDC, 1 mA)

##### • Contact a input for both input A and B (no voltage)

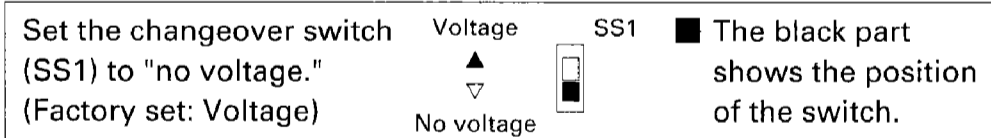

Use a micro-current contact.  
(Max. 12 VDC, 1 mA)

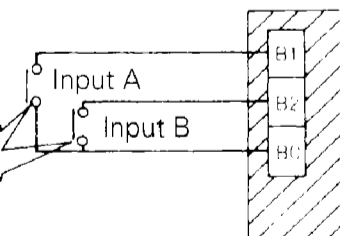

#### Control mode switch (RS) setting

You can select control mode at input A and B with the control mode switch on the PC board adaptor.  
(Factory set: 2)



(A) If you want to disregard input for wiring check, set to position 1 (direction of arrow).

(B) If operating using input A for constant input:

Position	Input A
2	Unified ON by switching from OFF to ON
	Unified OFF by switching from ON to OFF

\* Input B is disregarded.

(C) If operating using instantaneous input for input A and input B, use instantaneous input of at least 400 msec ON time.

Position	Input A	Input B
3	ON: Unified ON	ON: Unified OFF

Set all switches before turning on the power supply.

### (3) External control input (wiring to host computer monitor panel, etc.)

#### • Fetching the display signal

Normal operation output terminals (W1, W2) and malfunction output terminals (W3, W4) are for contact output with no voltage. (Allowable current per contact is 10 mA~3 A.)

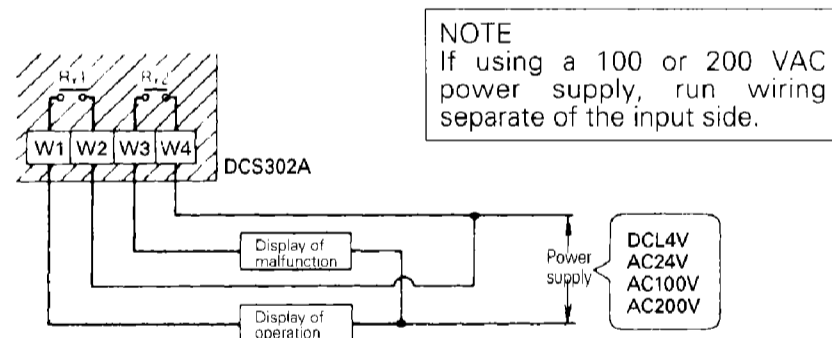

Output is as described below.

RY1 and RY2 both OFF	RY1 only ON	RY2 only ON
All indoor units are stopped.	No malfunction has occurred and at least one unit is operating.	At least 1 unit has stopped due to malfunction, or a malfunction of transmission has occurred between central remote controller and indoor unit.

#### Installation of DCS302A2

- Install inside the control panel in the same place as the central remote controller in the field. (Length of attached wiring is approx. 5 m.)
- Fasten securely with the attached screws.

